

FABRICATORS SUPPLY

SINK & FAUCET REFERENCE GUIDE

VOLUME 3.1



Fabricators
supply INCORPORATED

Sink MHK110-28WH | Faucet FF3450 | Soap Dispenser SD3450 | Air Switch WD3428SN | Cold Water Faucet DW13050

ELKAY

KARRAN

FRANKE

KINDRED

Chemcore
Industries

3 EASY STEPS FOR SELECTING YOUR SINK:

1

Stainless Steel or Color

- Granite Composite
- Fireclay
- China
- Acrylic

2

Undermount Top Mount/Drop in Apron Front/Farm Sink

3

- ### Style
- Single bowl
 - Equal Double Bowl
 - Combination



Franke CUX120



Franke Grande GDX12031

Min. Cabinet Required: 36"
O.D. 32-7/8" x 18-3/4" x 9"
18 gauge

Strainer basket(s) not included
Bottom grids available

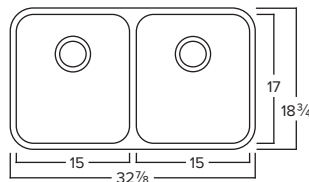

Franke Grande GDX11031

Min. Cabinet Required: 36"
O.D. 32-3/4" x 18-3/4" x 9"
18 gauge

Strainer basket not included
Bottom grid available

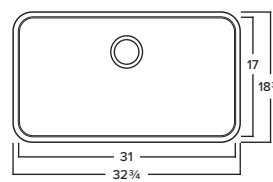

Franke Grande GDX11012

Min. Cabinet Required: 18"
O.D. 13-3/4" x 18-3/4" x 8"
18 gauge

Strainer basket(s) not included
Bottom grid available

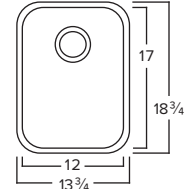

Franke RGX-160

Min. Cabinet Required: 36"
O.D. 31-1/2" x 20-1/2" x 8-7/8"
(Small 6-7/8")
18 gauge

Strainer basket(s) not included
Bottom grids available

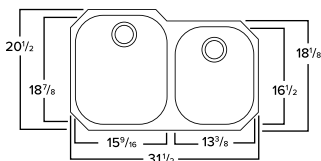

Franke Cube CUX11015

Min. Cabinet Required: 21"
O.D. 16-1/2" x 17-3/4" x 9"
18 gauge

Strainer basket(s) not included
Bottom grid available

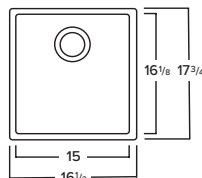

Franke CUX120

Min. Cabinet Required: 36"
O.D. 31-1/2" x 17-3/4" x 9"
18 gauge

Strainer basket(s) not included
Bottom grids available

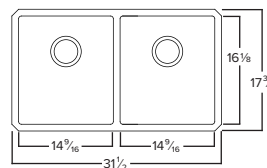

Franke CUX11030

Min. Cabinet Required: 36"
O.D. 31-1/2" x 17-3/4" x 9"
18 gauge

Strainer basket(s) not included
Bottom grid available

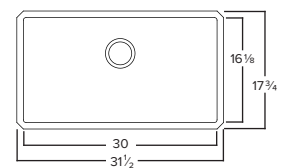

UNDERMOUNT - STAINLESS STEEL



Kindred KSS7UA-9DN



Karran BC-5050

Min. Cabinet Required: 36"
O.D. 32-1/2" x 18-1/4" x 9"
18 gauge

Strainer basket(s) not included

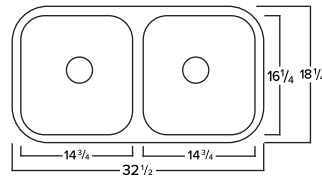

Karran BC-6040R

Min. Cabinet Required: 36"
O.D. 32-1/4" x 20-3/4" x 9" (Small 7")
18 gauge

Strainer basket(s) not included

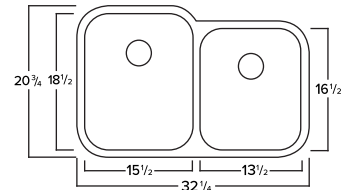

Kindred QSUA1816-8N

Min. Cabinet Required: 18"
O.D. 15-3/4" x 17-3/4" x 8"
20 gauge

Strainer basket(s) not included
Bottom grid available

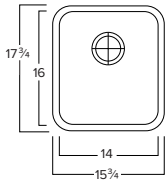

Kindred QDUA1831-8N

Min. Cabinet Required: 33"
O.D. 30-7/8" x 17-3/4" x 8"
20 gauge

Strainer basket(s) not included
Bottom grids available

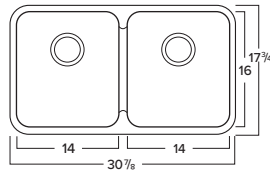

Kindred ND1831UA-9N

Min. Cabinet Required: 33"
O.D. 30-7/8" x 17-3/4" x 8-1/2"
18 gauge

Strainer basket(s) not included
Bottom grids available

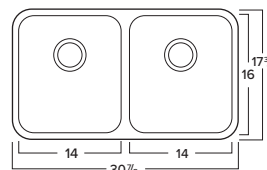

***DISCONTINUED**

(replacement to come)

Kindred KSS4UA-9DN

Min. Cabinet Required: 18"
O.D. 16-3/4" x 18-3/4" x 9"
18 gauge

Strainer basket(s) not included
Bottom grid included

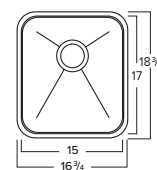

Elkay ELUH3120R

Min. Cabinet Required: 36"
O.D. 31-1/4" x 20-1/2" x 9-7/8"
(Small 7-7/8")
18 gauge

Strainer basket(s) not included
Bottom grids available

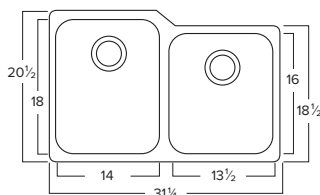

Elkay ELUH281610

Min. Cabinet Required: 36"
O.D. 30-1/2" x 18-1/2" x 10"
18 gauge

Strainer basket(s) not included
Bottom grid available

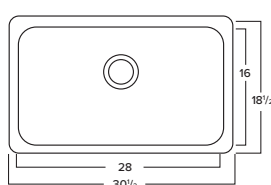

Elkay ELUH3118

Min. Cabinet Required: 36"
O.D. 30-3/4" x 18-1/2" x 7-7/8"
18 gauge

Strainer basket(s) not included
Bottom grids available

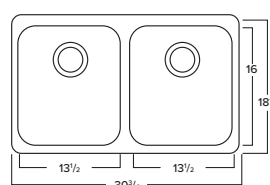

Elkay ELUH3118

UNDERMOUNT - APRON FRONT

Retro-Fit

NO APRON FRONT CABINET NEEDED



Elkay ECTRUF32179R

Min. Cabinet Required: 36"
O.D. 35-7/8" x 20-1/4" x 9"
18 gauge

Strainer basket(s) not included
Bottom grids available

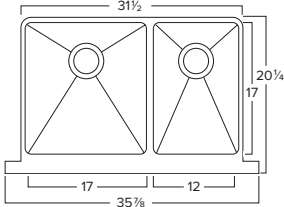

Karran QA-750

Min. Cabinet Required: 36"
O.D. 34" x 21-1/4" x 9-1/4"
(Interior depth 9")
Colors: White, Bisque, Grey, Black,
Concrete, or Brown (see colors on pg 7)

Strainer basket(s) not included
Bottom grids available

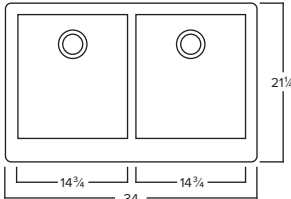

***DISCONTINUED**
(replacement to come)
Franke FFD33B-9-18
Min. Cabinet Required: 36"
O.D. 33" x 19" x 9"
18 gauge

Strainer basket(s) not included

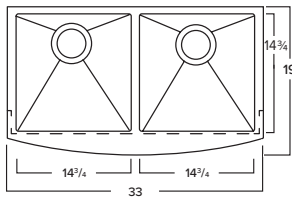

***DWO Franke FFS30B-10-18**
Min. Cabinet Required: 33"
O.D. 30" x 20-3/4" x 10"
18 gauge

Strainer basket(s) not included

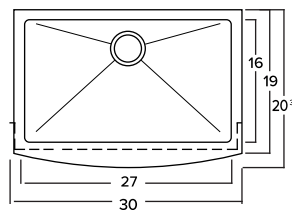

***DISCONTINUED**
(replacement to come)
Franke FFS33B-10-18
Min. Cabinet Required: 36"
O.D. 33" x 20-3/4" x 10"
18 gauge

Strainer basket(s) not included

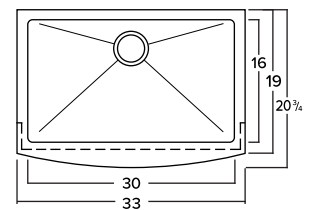

THOMPSON TRADERS

Copper Sink Options Available to Order

Copper sinks from Thompson Traders are virtually maintenance free. Copper sinks do not require harsh chemical cleaning, and with proper care, its beauty will last a lifetime. Unlike many other types of sinks, copper sinks grow in beauty with age.

Quiroga KDA-3322AH
Antique Copper

Quiroga KSA-3322HSS
Hammered Stainless Steel

(Thompson Traders Special Order)
Hidalgo KDU-6040BC
Aged Copper

Fireclay - Apron Front



Franke MHK720-31

Min. Cabinet Required: 33"
O.D. 31-1/4" x 19-7/8" x 8-5/8"
(Interior depth 7-7/8")
Colors: White

Strainer basket(s) not included
Bottom grids available

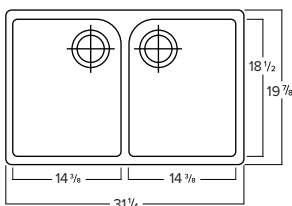

Franke FHK710-33

Min. Cabinet Required: 36"
O.D. 33" x 20" x 10-1/8"
(Interior depth 9-3/16")
Colors: White

Strainer basket(s) not included
Bottom grid available

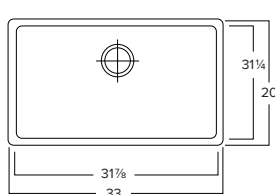

Franke FHK710-30

Min. Cabinet Required: 33"
O.D. 30-1/8" x 20" x 10-1/8"
(Interior depth 9-3/16")
Colors: White or Linen

Strainer basket(s) not included
Bottom grid available

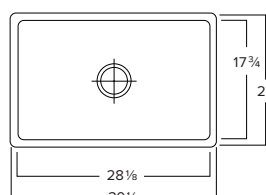

Franke MHK110-24

Min. Cabinet Required: 27"
O.D. 23-5/8" x 19-7/8" x 8-1/8"
(Interior depth 7-1/8")
Colors: White, Bisque or Matte Black

Strainer basket(s) not included
Bottom grid available

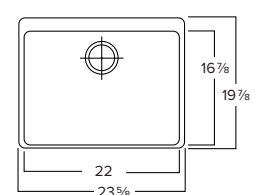

UNDERMOUNT - COMPOSITE

Stock Colors:

***DWO**

Mocha

Onyx

Champagne



Franke PKG11031

Min. Cabinet Required: 36"
O.D. 32" x 18-3/4" x 9-1/2"

Colors: Onyx or Champagne
Limited Qty Colors: Mocha

Drain cover included
Strainer basket(s) not included
Bottom grid available

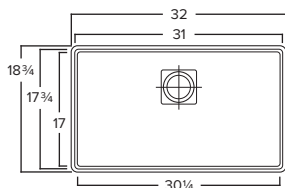

*DWO Franke KBG11031

Min. Cabinet Required: 36"
O.D. 32-3/8" x 18-1/2" x 9-1/2"

Limited Qty Colors: Onyx,
Mocha, & Champagne

Strainer basket(s) not included
Bottom grid available

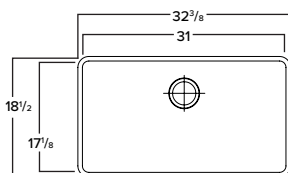

*DWO Franke KBG11013

Min. Cabinet Required: 18"
O.D. 15" x 17-3/8" x 9"

Limited Qty Colors: Onyx,
Mocha, & Champagne

Strainer basket(s) not included
Bottom grid available

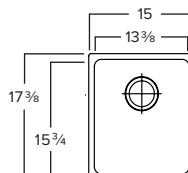

Franke PKG11031



Karran Q-350

Min. Cabinet Required: 36"
O.D. 32-3/8" x 19" x 8-1/2"

Colors: White, Bisque, Grey, Black,
Concrete, or Brown

Strainer basket(s) not included
Bottom grids available

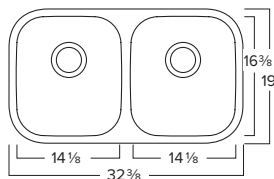

Elkay ELGU3322

Min. Cabinet Required: 36"
O.D. 33" x 18-1/2" x 9-1/2"

Colors: White, Bisque, Black, Mocha,
Dusk Gray, or Greige

Strainer basket(s) not included
Bottom grids available

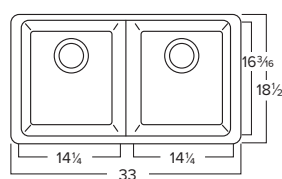

Elkay ELGU250R

Min. Cabinet Required: 36"
O.D. 33" x 20-1/2" x 9-1/2"

Colors: White, Bisque, Black, Mocha,
or Dusk Gray

Strainer basket(s) not included
Bottom grids available

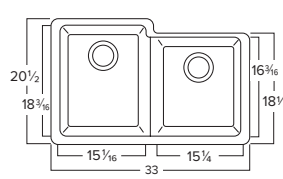

Elkay ELG1616

Min. Cabinet Required: 21"
O.D. 15-3/4" x 15-3/4" x 7-11/16"

Colors: White, Bisque, Black, Mocha,
or Dusk Gray

Strainer basket(s) not included
Bottom grid available

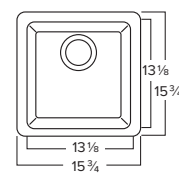

*This is a running change from the ELG1515.
Small difference in sizes.



Kindred KGDCR1U-8N

Min. Cabinet Required: 33"
O.D. 31-1/2" x 18-1/8" x 8" (Small 7")

Colors: Champagne, Onyx,
or Shadow Grey
Limited Qty Colors: Espresso/Mocha
& Storm

Stainless strainer basket(s) not included
1 Bottom grid included

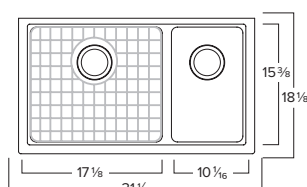

Kindred KGD1U-8N

Min. Cabinet Required: 33"
O.D. 31-1/2" x 18-1/8" x 8"

Colors: Champagne, Onyx,
or Shadow Grey
Limited Qty Colors: Espresso/Mocha
& Storm

Stainless strainer basket(s) not included
1 Bottom grid included

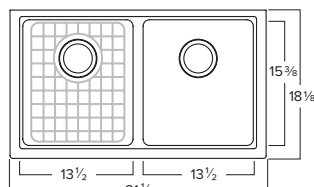

Kindred KGS1U-8N

Min. Cabinet Required: 33"
O.D. 31-9/16" x 18-1/8" x 8"

Colors: Champagne, Onyx,
or Shadow Grey
Limited Qty Colors: Espresso/Mocha
& Storm

Stainless strainer basket(s) not included
Bottom grid included

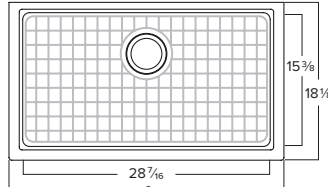

Kindred KGD2U-9N

Min. Cabinet Required: 36"
O.D. 33" x 19-3/8" x 9" (Small 8")

Colors: Champagne, Onyx,
or Shadow Grey
Limited Qty Colors: Espresso/Mocha
& Storm

Stainless strainer basket(s) not included
1 Bottom grid included

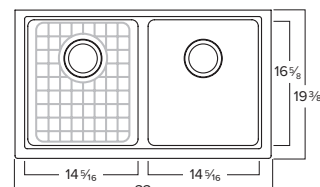

DIRECT TO LAMINATE UNDERMOUNT

300 Series - Universal appeal, great value



Karran E-350

Min. Cabinet Required: 36"
O.D. 32-3/8" x 19" x 8-1/2"
18 Gauge

Strainer basket(s) not included
Bottom grids available

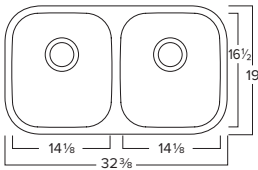

Karran E-360R

Min. Cabinet Required: 36"
O.D. 32-3/8" x 21-1/8" x 8-3/8"
(Small 6-1/4")
18 Gauge

Strainer basket(s) not included
Bottom grids available

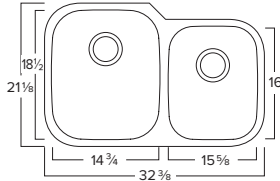

Karran E-340

Min. Cabinet Required: 36"
O.D. 30-3/4" x 18-7/8" x 9"
18 Gauge

Strainer basket(s) not included
Bottom grid available

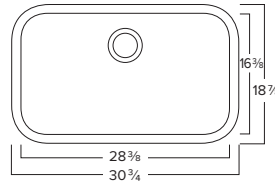

Karran E-320

Min. Cabinet Required: 27"
O.D. 24-1/8" x 18-1/8" x 9"
18 Gauge

Strainer basket(s) not included
Bottom grid available

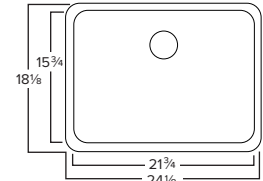

400 Series - Modern square styling, value priced



Karran E-440

Min. Cabinet Required: 36"
O.D. 32" x 18-1/4" x 9"
18 gauge

Strainer basket(s) not included
Bottom grid available

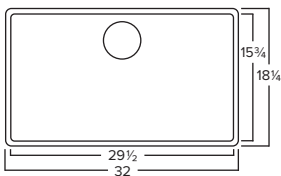

Karran E-420

Min. Cabinet Required: 27"
O.D. 24-1/4" x 18-1/4" x 9"
18 gauge

Strainer basket(s) not included
Bottom grid available

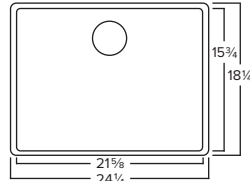

Karran E-415

Min. Cabinet Required: 18"
O.D. 16-1/4" x 18-1/4" x 5-1/2"
18 gauge

Strainer basket(s) not included
Bottom grid available

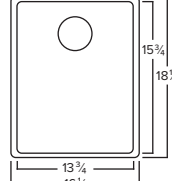

Karran E-410

Min. Cabinet Required: 18"
O.D. 16-1/4" x 18-1/4" x 9"
18 gauge

Strainer basket(s) not included
Bottom grid available

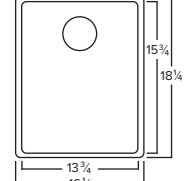

500 Series - Hand crafted, modern square styling



Karran E-550



Karran E-540

Min. Cabinet Required: 36"
O.D. 32-1/2" x 19-1/2" x 9"
18 Gauge

Strainer basket(s) not included
Bottom grid available

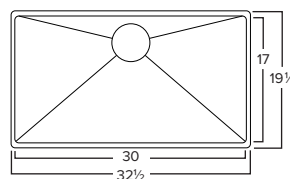

Karran E-550

Min. Cabinet Required: 36"
O.D. 33-7/8" x 19-1/2" x 9"
18 Gauge

Strainer basket(s) not included
Bottom grids available

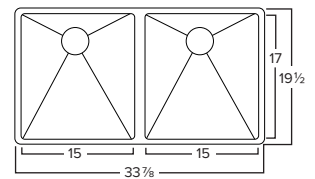

A professional fabricator is recommended to do this undermount application in laminate.

This is something that is installed as tops are made - cannot be added once tops are installed on job site.

DIRECT TO LAMINATE UNDERMOUNT



Karran E-560R
 Min. Cabinet Required: 36"
 O.D. 32" x 21-1/2" x 9" (Small 9")
 18 Gauge

Strainer basket(s) not included
 Bottom grids available

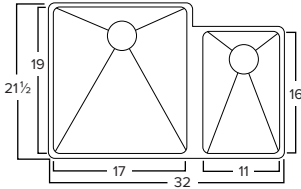

Karran E-560L
 Min. Cabinet Required: 36"
 O.D. 32" x 21-1/2" x 9" (Small 9")
 18 Gauge

Strainer basket(s) not included
 Bottom grids available

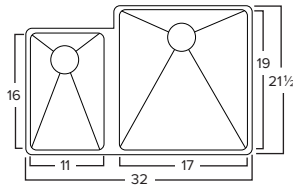

Karran E-520
 Min. Cabinet Required: 27"
 O.D. 23-1/2" x 19-1/2" x 9"
 18 Gauge

Strainer basket(s) not included
 Bottom grid available

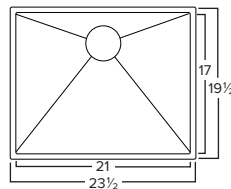

Karran E-510
 Min. Cabinet Required: 18"
 O.D. 15-1/2" x 19-1/2" x 9"
 18 Gauge

Strainer basket(s) not included
 Bottom grid available

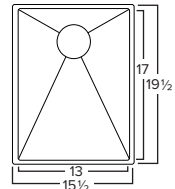

Granite Composite

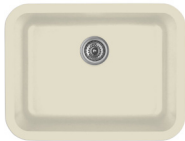

Karran Q-320
 Min. Cabinet Required: 27"
 O.D. 24-1/4" x 18-1/4" x 8-1/2"
 Colors: White, Bisque, Grey, Black, Concrete, or Brown

Strainer basket(s) not included
 Bottom grid available

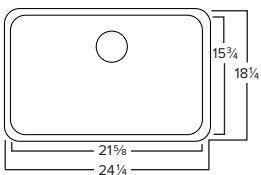

Karran Q-350
 Min. Cabinet Required: 36"
 O.D. 32-3/8" x 19" x 8-1/2"
 Colors: White, Bisque, Grey, Black, Concrete, or Brown

Strainer basket(s) not included
 Bottom grids available

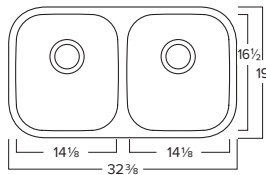

Karran Q-360R
 Min. Cabinet Required: 36"
 O.D. 32-1/2" x 21" x 8-1/2"
 (Small 7-1/2")
 Colors: White, Bisque, Grey, Black, Concrete, or Brown

Strainer basket(s) not included
 Bottom grids available

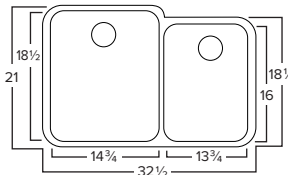

Karran Q-340
 Min. Cabinet Required: 33"
 O.D. 30-7/8" x 18-7/8" x 9"
 Colors: White, Bisque, Grey, Black, Concrete, or Brown

Strainer basket(s) not included
 Bottom grid available

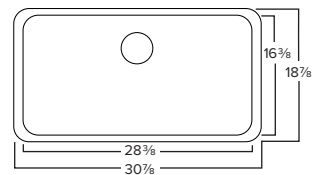

Karran Q-315
 Min. Cabinet Required: 21"
 O.D. 16-5/8" x 16-5/8" x 8"
 Colors: White, Bisque, Grey, Black, Concrete, or Brown

Strainer basket(s) not included

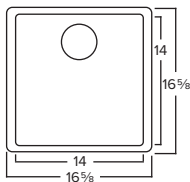

Stock Colors:

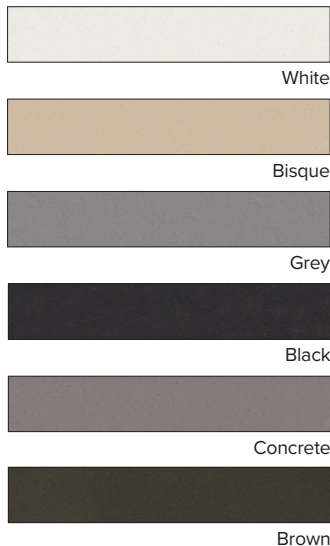

Karran Q-350

DIRECT TO LAMINATE UNDERMOUNT

Acrylic



Karran A-350



Karran A-350

Min. Cabinet Required: 36"

O.D. 32-7/8" x 19-1/8" x 9"

Colors: White or Bisque

Strainer basket(s) not included

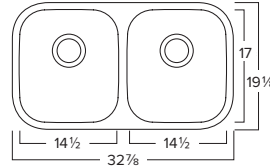

Karran A-340

Min. Cabinet Required: 36"

O.D. 30-1/2" x 18-1/2" x 9"

Colors: White or Bisque

Strainer basket(s) not included

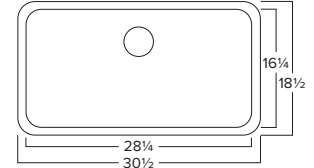

Karran A-320

Min. Cabinet Required: 27"

O.D. 24" x 17-1/2" x 9"

Colors: White or Bisque

Strainer basket(s) not included

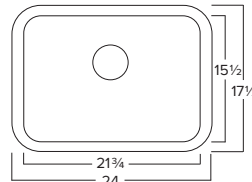

Karran A-315

Min. Cabinet Required: 18"

O.D. 14" x 17" x 6"

Colors: White or Bisque

Strainer basket(s) not included

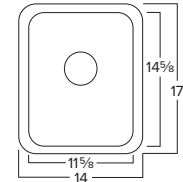

Vanity (All Karran Vanities - ADA)



Karran A-306

O.D. 19" x 15" x 6"

Colors: White or Bisque

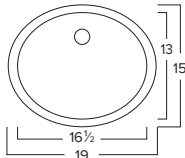

Karran A-309

O.D. 21" x 14" x 5-3/4"

Colors: White or Bisque

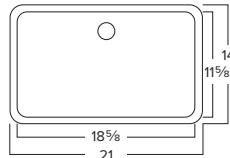

Karran A-309

Stainless Steel



Karran E-303

O.D. 17-7/8" x 14-5/8" x 5-3/4"

18 Gauge

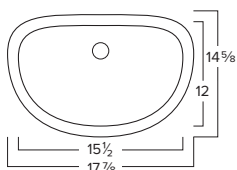

Karran E-305

O.D. 15-1/4" x 15-1/4" x 5-3/4"

18 Gauge

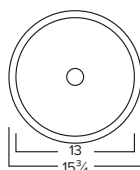

Granite Composite



Karran Q-306

O.D. 19" x 15" x 5-1/2"

Colors: Black, Brown, Concrete, Grey, Bisque and White

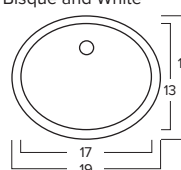

Karran Q-306

COMPOSITE DROP IN SINKS

Franke Granite



Franke DIG61091-CHA (champagne)
***DWO DIG61091-MOC** (mocha)
 Min. Cabinet Required: 36"
 O.D. 33" x 22" x 9"

Strainer basket(s) not included
 Bottom grid available

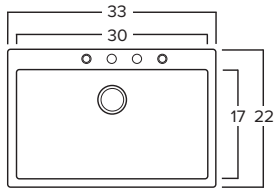

Franke ESCH25229-1 (champagne)
***DWO ESDB25229-1** (mocha)
ESOX25229-1 (onyx)
 Min. Cabinet Required: 27"
 O.D. 25" x 22" x 9"

Strainer basket(s) not included
 Bottom grid available

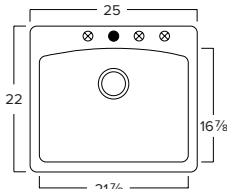

Franke EDCH33229-1 (champagne)
***DWO EDDB33229-1** (mocha)
EDOX33229-1 (onyx)
 Min. Cabinet Required: 36"
 O.D. 33" x 22" x 9"

Strainer basket(s) not included
 Bottom grids available

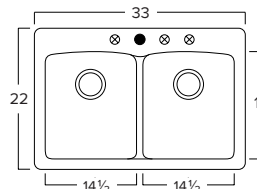

Franke EOCH33229-1 (champagne)
***DWO EODB33229-1** (mocha)
EOOX33229-1 (onyx)
 Min. Cabinet Required: 36"
 O.D. 33" x 22" x 9" & 8"

Strainer basket(s) not included
 Bottom grids available

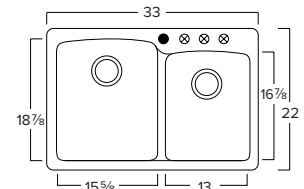

Kindred Granite



Kindred KGSL2031-8N
 Min. Cabinet Required: 33"
 O.D. 31-9/16" x 20-1/2" x 8"
 Stainless strainer basket(s) not included
 Bottom grid included

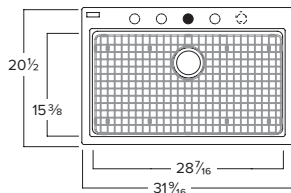

Kindred KGSL2023-8N
 Min. Cabinet Required: 27"
 O.D. 23" x 20-1/2" x 8"
 Stainless strainer basket(s) not included
 Bottom grid included

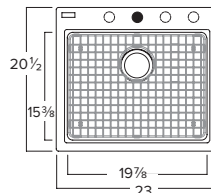

Kindred KGSL2017-8N
 Min. Cabinet Required: 18"
 O.D. 16-3/4" x 20-1/2" x 8"
 Stainless strainer basket(s) not included
 Bottom grid included

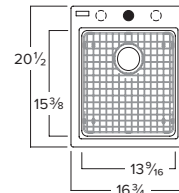

Kindred KGDL2031-8N
 Min. Cabinet Required: 33"
 O.D. 31-1/2" x 20-1/2" x 8"
 Stainless strainer basket(s) not included
 1 Bottom grid included

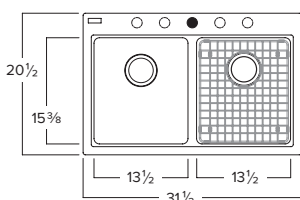

Kindred KGDC2031R-8N
 Min. Cabinet Required: 33"
 O.D. 31-9/16" x 20-1/2" x 8" (Small 7")
 Stainless strainer basket(s) not included
 1 Bottom grid included

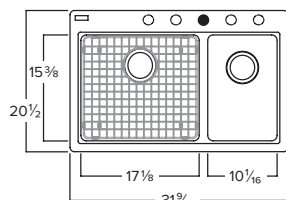

Kindred KGDC2027R-8N
 Min. Cabinet Required: 30"
 O.D. 27-3/4" x 20-1/2" x 8" (Small 7")
 Stainless strainer basket(s) not included
 1 Bottom grid included

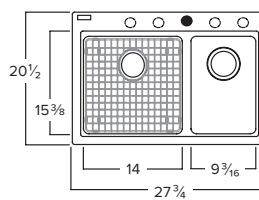

Kindred KGDL2233-9N
 Min. Cabinet Required: 36"
 O.D. 33" x 22" x 9" (Small 8")
 Stainless strainer basket(s) not included
 1 Bottom grid included

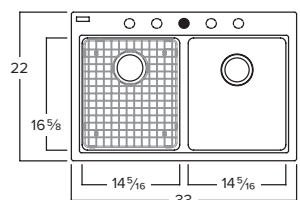

DROP IN SINKS

Stainless Steel

20 GAUGE KINDRED DROP IN'S HAVE MIRRORED FINISHED RIMS



**Kindred
QDLA2233-8-1N
QDLA2233-8-3N
QDLA2233-8-4N**
(4 Hole: Special Order Only)

Min. Cabinet Required: 36"
O.D. 33-3/8" x 22" x 8"
20 Gauge
1, 3 or 4 Hole

**Strainer basket(s) not included
Bottom grids available**

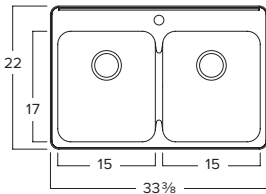

**Kindred
QDL2031-7-1N QDL2031-8-1N
QDL2031-7-3N QDL2031-8-3N
QDL2031-7-4N QDL2031-8-4N**

Min. Cabinet Required: 33"
O.D. 31-1/4" x 20-1/2" x 7" (& 8")
20 Gauge
1, 3 or 4 Hole

**Strainer basket(s) not included
Bottom grids available**

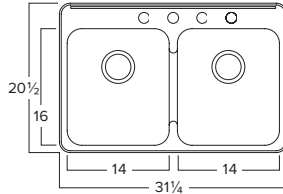

**Kindred
QCM2033-8-1N**
Min. Cabinet Required: 36"
O.D. 33-1/4" x 20-1/8" x 8"
20 Gauge
1 Hole

**Strainer basket(s) not included
Bottom grid available (1)**

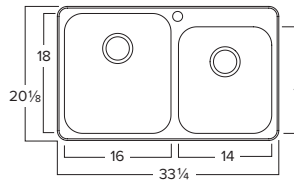

**Kindred
QSLA2233-8-1N
QSLA2233-8-3N
QSLA2233-8-4N**

Min. Cabinet Required: 36"
O.D. 33-3/8" x 22" x 8"
20 Gauge
1, 3 or 4 Hole

**Strainer basket(s) not included
Bottom grid available**

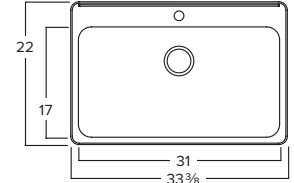

Kindred QDLA2233-8-1N



**Kindred
QSLA2031-8-1N
QSLA2031-8-3N
QSLA2031-8-4N**

Min. Cabinet Required: 33"
O.D. 31-1/4" x 20-1/2" x 8"
20 Gauge
1, 3 or 4 Hole

**Strainer basket(s) not included
Bottom grid available**

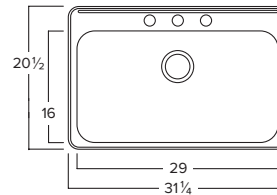

**Kindred
QSLA2225-8-1N
QSLA2225-8-3N
QSLA2225-8-4N**

Min. Cabinet Required: 27"
O.D. 25-1/4" x 22" x 8"
20 Gauge
1, 3 or 4 Hole

**Strainer basket(s) not included
Bottom grid available**

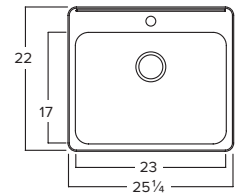

**Elkay Slim Rim - 1 faucet hole in stock
ECTSR33229TBG1 (Single Bowl)**
Min. Cabinet Required: 36"
O.D. 33" x 22" x 9"
18 Gauge

**Strainer basket(s) not included
Bottom grid included**

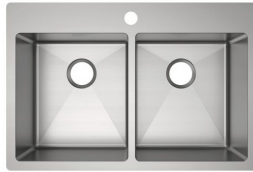
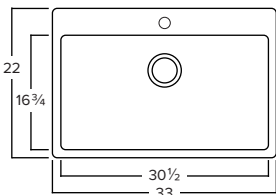

**Elkay Slim Rim - 1 faucet hole in stock
ECTSR33229TBG1 (Double Bowl)**
Min. Cabinet Required: 36"
O.D. 33" x 22" x 9"
18 Gauge

**Strainer basket(s) not included
Bottom grids included**

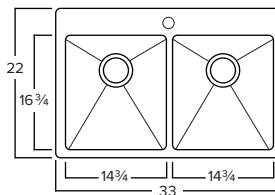

Elkay ECTSR33229TBG1



Kindred CSLA2522-8-4CBN with Faucet KFPO2200 and Soap Dispenser KSD10A



Kindred
FCDLA3322-8-1CBN
FCDLA3322-8-4CBN
Min. Cabinet Required: 36"
 O.D. 33" x 22" x 8"
 18 Gauge
 1 or 4 Hole
 Strainer basket(s) not included
 Bottom grids available

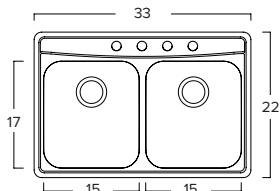

Kindred
RDLA3319-6-4CBN
Min. Cabinet Required: 36"
 O.D. 32-15/16" x 18-15/16" x 6"
 22 Gauge

Strainer basket(s) not included

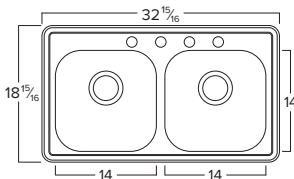

Kindred
CSLA2522-8-4CBN
Min. Cabinet Required: 27"
 O.D. 25" x 22" x 8"
 20 Gauge

Strainer basket(s) not included
 Bottom grid available

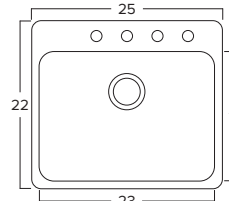

Laundry/Utility Sinks



Kindred
QSL2020-10-1N
QSL2020-10-3N
Min. Cabinet Required: 24"
 O.D. 20-1/8" x 20-9/16" x 10"
 20 Gauge
 1 or 3 Hole

Strainer basket(s) not included
 Bottom grid available

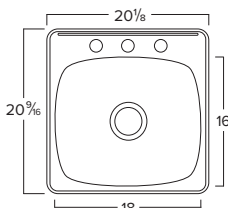

Kindred
QSLF2020-10-1 **QSLF2020-12-1**
QSLF2020-10-3 **QSLF2020-12-3**
Min. Cabinet Required: 24"
 O.D. 20-1/8" x 20-9/16" x 10" (& 12")
 18 Gauge
 1 or 3 Hole

Strainer basket(s) included
 Bottom grid available

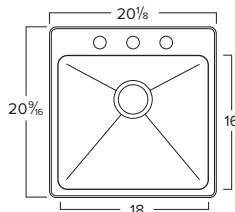

Kindred
QSL1719-8-1N
QSL1719-8-2N
QSL1719-8-3N
Min. Cabinet Required: 21"
 O.D. 19-1/8" x 17" x 8"
 20 Gauge
 1, 2 or 3 Hole

Strainer basket(s) not included
 Bottom grid available

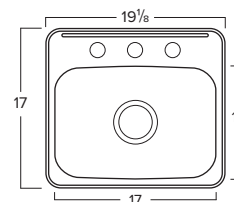

PORCELAIN VANITY BOWLS

Vessel Sinks for any material (Drains not included)



Chemcore APRON
O.D. 20-1/2" x 16-3/4" x 6-7/8"
Bowl Depth: 4-1/2"
White or Bisque

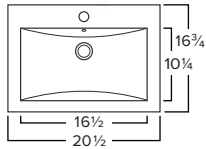

Chemcore BLOOM
O.D. 18" x 18" x 7-1/4"
Bowl Depth: 6"
White or Bisque

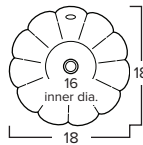

Chemcore CANOE
O.D. 23-1/4" x 15" x 7-1/2"
Bowl Depth: 4-3/4"
White

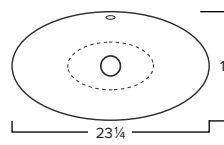

Chemcore CONTOUR
O.D. 16-1/2" x 16-1/2" x 5-3/8"
Bowl Depth: 4"
White, Bisque, or Black

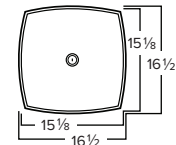

Chemcore TUB
O.D. 18-3/4" x 13-1/4" x 5-1/2"
Bowl Depth: 4-1/2"
White or Bisque

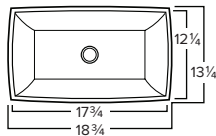

Chemcore BOX
O.D. 20-1/2" x 16-1/4" x 7"
Bowl Depth: 5"
White or Bisque

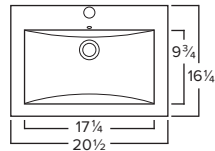

Chemcore Mixer
O.D. 16-1/2" x 16-1/2" x 7"
Bowl Depth: 5"
White & Bisque

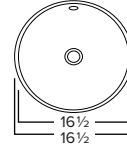

Chemcore CONE
O.D. 18-1/2" x 18-1/2" x 6-1/4"
Bowl Depth: 4-1/2"
White

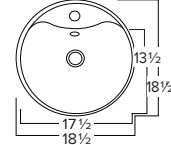

Chemcore Box

PORCELAIN VANITY BOWLS

Drop-In Sinks for any material (Drains not included)



Chemcore DERBY
O.D. 17-1/2" x 15-1/2" x 7"
Bowl Depth: 5-1/4"
White or Black

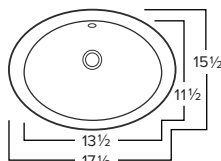

Chemcore DAISY
O.D. 21-3/4" x 18-5/8" x 8-1/4"
Bowl Depth: 6-3/8"
White or Bisque
1 hole

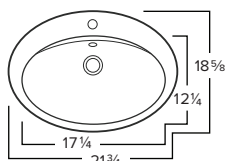

Chemcore DAISY 3-Hole
O.D. 22-1/8" x 18-7/8" x 8-1/2"
Bowl Depth: 6"
White or Bisque
3 hole (4" center)

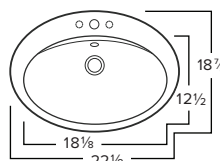

Chemcore LEDGE
O.D. 21-1/4" x 18" x 6-3/4"
Bowl Depth: 5"
White or Bisque
1 hole or 3 hole (4" center)

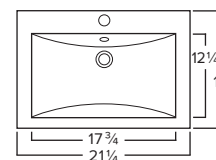

Undermount Sinks for Stone or Solid Surface (Drains not included)



Chemcore LOTUS
O.D. 19-3/8" x 15-3/4" x 8-1/4"
Bowl Depth: 6-1/2"
White, Bisque, or Black

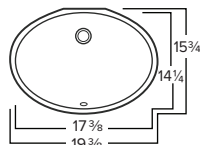

Chemcore ACORN
O.D. 17-1/8" x 14" x 7-3/4"
Bowl Depth: 6"
White, Bisque, or Black

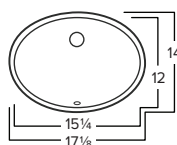

Chemcore BUD
O.D. 15-1/2" x 13-1/2" x 8"
Bowl Depth: 6-1/4"
White or Bisque

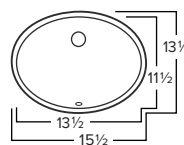

Chemcore TROUGH
O.D. 23-1/2" x 14-1/2" x 7-3/4"
Bowl Depth: 5-1/2"
White or Bisque

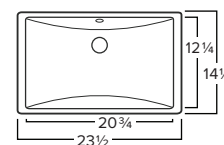

Chemcore TRENCH
O.D. 20-7/8" x 14-5/8" x 8-1/4"
Bowl Depth: 6-1/4"
White or Bisque

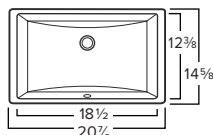

Chemcore BASIN
O.D. 20-7/8" x 13-5/8" x 7-1/4"
Bowl Depth: 5-1/2"
White or Bisque

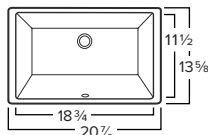

Chemcore DART
O.D. 18-1/8" x 13" x 7"
Bowl Depth: 5-1/2"
White or Bisque

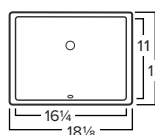

Chemcore Lotus

A TIP ON TALL FAUCETS

If installing a tall faucet in a laminate top be aware that because of their height there is a higher chance of water splashing back and potentially leaking into the core of the top at the backside. If a tall faucet is desired for a laminate top, a postform style or covered backsplash in laminate is best. Extra care may be needed in drying the tops after use due to splashing.

ELKAY - BAR FAUCET
LKEC2012AS

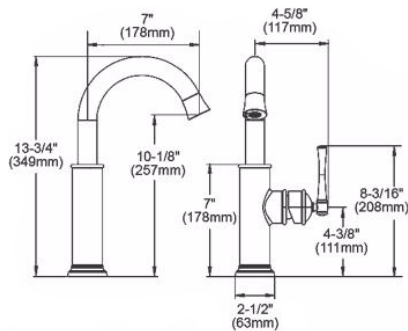

Arc Spout
13 3/4" Height
Finish: Antique Steel
Stream Only
Forward Only Handle

ELKAY
LKEC2031AS

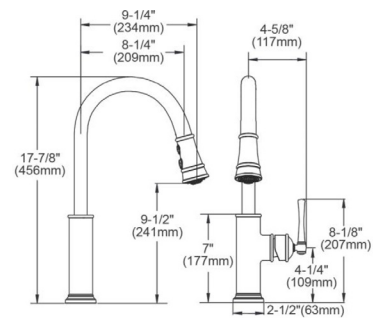

Arc Spout
17 7/8" Height
Finish: Antique Steel
Stream - Spray - Pause
Forward Only Handle

ELKAY
LK6000CR

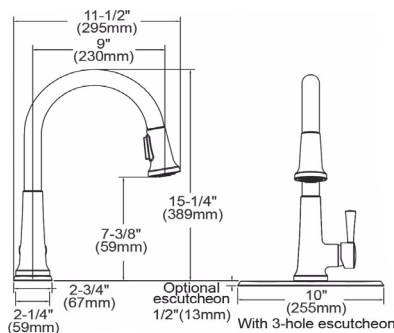

Arc Spout/Pull Down Spray
15 1/4" Height
Finish: Chrome
Stream - Spray - Pause

ELKAY
LK6000LS

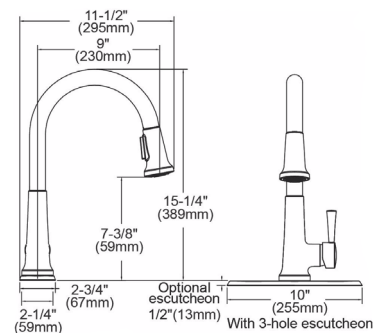

Arc Spout/Pull Down Spray
15 1/4" Height
Finish: Lustrous Steel
Stream - Spray - Pause

**FRANKE
FF4400**

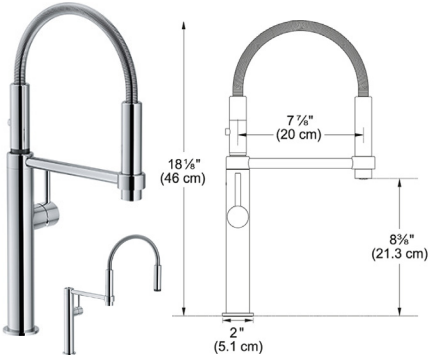

360° SemiPro
18 1/8" Height
Finish: Polished Chrome
Stream or Spray

**FRANKE
FF4480**

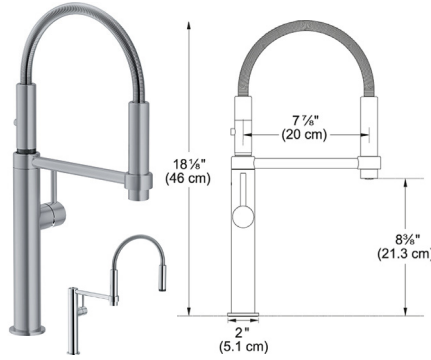

360° SemiPro
18 1/8" Height
Finish: Satin Nickel
Stream or Spray

**FRANKE
FF4420**

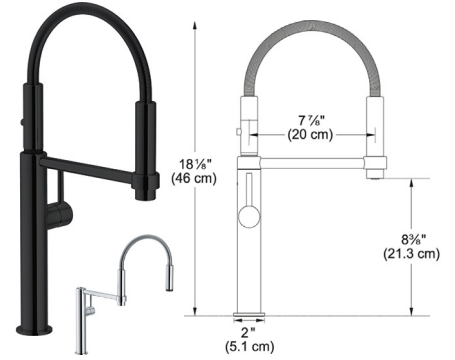

360° SemiPro
18 1/8" Height
Finish: Matte Black
Stream or Spray

REPLACEMENTS COMING SOON

***DWO FRANKE
FF3940**



Pull Down Spray
15 1/8" Height
Finish: Gun Metal
Stream or Spray

***DWO FRANKE
FF3980**



Pull Down Spray
15 1/8" Height
Finish: Satin Nickel
Stream or Spray

***DWO FRANKE
FF3990**

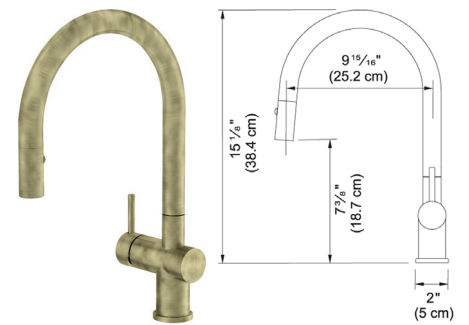

Pull Down Spray
15 1/8" Height
Finish: Satin Brass
Stream or Spray

***DWO FRANKE
FF3801**

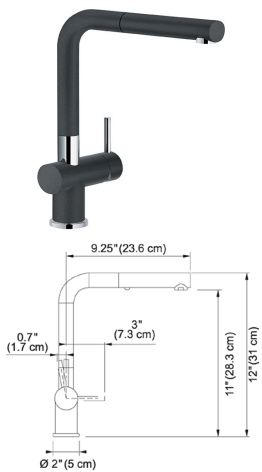

Pull Out Spray
12" Height
Finish: Onyx/Chrome
Stream or Spray

***DWO FRANKE
FF3880**

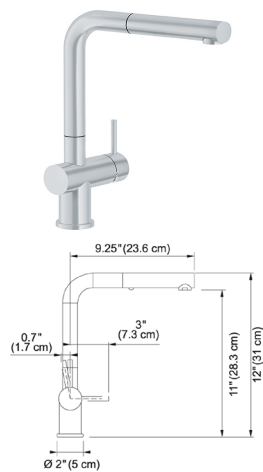

Pull Out Spray
12" Height
Finish: Satin Nickel
Stream or Spray

**FRANKE
FF3450**

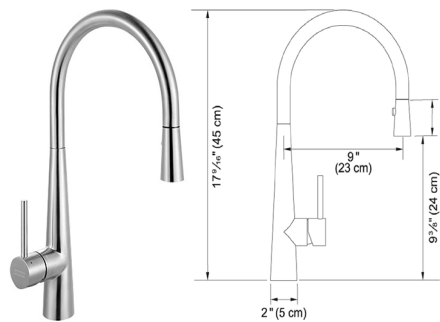

Arc Spout/Pull Down Spray
17 3/4" Height
Finish: Stainless Steel
Stream or Spray

Suitable for outdoor use

**FRANKE
FFPS3450**

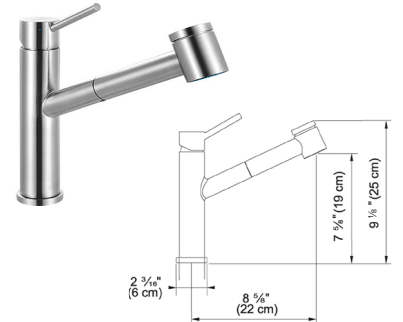

Pull Out Spray
9 1/2" Height
Finish: Stainless Steel
Stream or Spray

Suitable for outdoor use

DESIGNING YOUR KITCHEN AROUND YOUR SINK

THE IMPORTANCE OF MAKING THIS DECISION #1

1. Our sink vendors tell us over 75% of our time in the kitchen is spent at the sink. Makes sense to be a top priority choice.
2. Customer gets the sink they really want.
3. Sink Cabinet is designed to fit the sink. It could require a larger base, or maybe even a bump out. Or if apron front, special cabinet needs/support.
4. The customer could be looking for special accessories...soap dispenser, water filtration, hot/cold water dispenser, matching strainer baskets/disposal flange.
5. Confirming the sink works with the existing plumbing...too shallow, too deep.
6. Depth of sink...this is a good conversation to have regarding the customers' height and if they have to do a lot of bending when using sink.
7. Many times sink choices are based on the number faucet holes...not all have a variety of choices.
8. If decision waits until the end, more than likely it hasn't been budgeted in and the customer will "make do."

FOLLOWING IS BASED ON BUYING THROUGH FABRICATORS SUPPLY...

9. Our depth of inventory is great, and the name brand vendors we work with are solid. They stand behind their product. You provide quality design, we provide quality product.
10. Our engineering department has all the specs and info on our sinks. Customers who order their "sinks on line" create downtime as we try to research and find the correct cutouts or install applications. If there are sink issues during install with on-line purchase... project stops.
11. If something were to go wrong at install with our sink, we have a very good chance of having stock and getting another one off to the customer so the install can go on.
12. If our sister company, Fabricators Unlimited, is handling the project, the sink rides along with the countertop. We coordinate getting the two together.
13. There are times the sink was to be provided by the plumber, or on-site by homeowner, and neither happened. Delay in install.



828 NP Ave
Fargo, ND 58102
ph 701.298.0644
800.298.0644
fx 701.235.0584

3700 Global Dr
Bismarck, ND 58501
ph 701.223.4307
800.298.0644
fx 701.323.7143

130 Riverside Rd
Billings, MT 59101
ph 406.245.6770
800.298.0644
fx 406.245.6975

4501 103rd Ct NE
Suite 170
Blaine, MN 55014
763.270.0580
fx 763.444.1803

12811 Alfalfa Lane SW
Pillager, MN 56473
800.298.0644