

VOLUME 1



FUNCTIONAL
HARDWARE

BILLINGS, MT

BISMARCK, ND

BLAINE, MN

BRAINERD, MN

FARGO, ND

PH: 800.298.0644









FX: 701.235.0584

WWW.FABRICATORSSUPPLY.NET







HINGES - GENERAL INFORMATION

FRAMELESS

Suggested TAB Distance 		HINGE OVERLAY CHOICES				★ Indicates Preferred Choice
MOUNTING PLATE THICKNESS CHOICES		Full Overlay Hinge 'A'	1/2" Overlay Hinge 'D'	Half (3/8") Overlay Hinge 'G'	Inset Hinge 'P'	
	0mm	3/4" Overlay 19mm	9/16" Overlay 14mm	★ 3/8" Overlay 10mm		Desired Overlay
	2mm	11/16" Overlay 17mm	1/2" Overlay 12.5mm	★ 5/16" Overlay 8mm	Inset Door Plus Adjustment	
	3mm	5/8" Overlay 16mm	7/16" Overlay 11mm	★ 9/32" Overlay 7mm (Plus Adjustment)	★ Inset Door	
	6mm	★ 1/2" Overlay 12.5mm	5/16" Overlay 8mm	5/32" Overlay 4mm		
	9mm	3/8" Overlay 10mm	3/16" Overlay 5mm (Plus Adjustment)	Inset Door Plus Adjustment		
	12mm	1/4" Overlay 6mm	3/32" Overlay 2mm (Plus Adjustment)	Inset Door		
	18mm	Inset Door Plus Adjustment				

FACE FRAME

1" = 25.4mm		HINGE OVERLAY CHOICES				★ Indicates Preferred Choice
MOUNTING PLATE THICKNESS CHOICES		Full Overlay Hinge 'A'	1/2" Overlay Hinge 'D'	Half (3/8") Overlay Hinge 'G'	Inset Hinge 'P'	
	1mm	3/4" Overlay 19mm	1/2" Overlay 12.5mm	★ 3/8" Overlay 10mm 5/16" Overlay (3mm Tab)	For inset doors, on face frame cabinets, using a 'P' style hinge, refer to the "SAP" mounting plate system chart. 	Desired Overlay
	4mm	9/16" Overlay 15mm	3/8" Overlay 10mm	1/4" Overlay 6mm ★ 5/16" Overlay (5mm Tab)		
	BAL3R59		Inset Door (Use 3mm Tab)	★ Inset Door		
	BAM3R09	1-1/4" Overlay 32mm (Use 6mm Tab kit)				

REMAINING STEPS TO COMPLETE A HINGE SELECTION

1. Select the angle of the opening of the hinge. <input type="checkbox"/> 94 Degree <input type="checkbox"/> 110 Degree <input type="checkbox"/> 120 Degree <input type="checkbox"/> 155 Degree <input type="checkbox"/> 165 Degree	Adjustment Range 3/16" (4.5mm)  1/16" (1.5mm)
2. Select the fixing method to attach the hinge to the door. <input type="checkbox"/> Screw-on <input type="checkbox"/> Press-in Dowel <input type="checkbox"/> Rapido <input type="checkbox"/> Logica	
3. Select hinge closing style. <input type="checkbox"/> Self-Closing <input type="checkbox"/> Soft Closing "Silentia" <input type="checkbox"/> Self Opening "Push" <input type="checkbox"/> Free Swinging	
4. Select mounting plate grade. <input type="checkbox"/> Premium (2 cam adjustment) <input type="checkbox"/> Economy (1 cam adjustment)	
5. Select fixing method to attach the mounting plate to cabinet. <input type="checkbox"/> Wood Screw <input type="checkbox"/> Euro Screw <input type="checkbox"/> Expanding Dowel	
6. For "Silentia" Hinges: Verify cup boring depth with customer. <input type="checkbox"/> Series 100=12mm <input type="checkbox"/> Series 200=15.5mm <input type="checkbox"/> Series 700=13.5mm	
7. For "Push" Hinges: Select a release device style. <input type="checkbox"/> Mechanical release device <input type="checkbox"/> Magnetic release device	

KEY FOR HINGES:

Screw-In



Knock-In



Euro

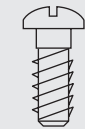





Rapido













Logica







SALICE® SERIES 200 HINGES - SELF & SOFT CLOSE



FULL OVERLAY "A"		SELF-CLOSE								SOFT-CLOSE					
		94°		110°		120°		165°		105°		110°		155°	
		SKU	P/N	SKU	P/N	SKU	P/N	SKU	P/N	SKU	P/N	SKU	P/N	SKU	P/N
	Screw In 			HS2110AS	C2P6A99	HS2120AS	C2P9A99	HS2165AS	C2PFA99						
	Knock In 	HS2094AK	C2RBA94	HS2110AK	C2R6A99	HS2120AK	C2R9A99	HS2165AK	C2RFA99			HS7110AKSE	C7R6AE9	HS2155AK	C2RMA99
	Logica 			HS2110AL	C2J6A99	HS2120AL	C2J9A99					HS7110ALSE	C7J6AE9		
	Rapido 			HS2110AR	C276A99	HS2120AR	C279A99	HS2165AR	C27FA99			HS7110ARSE	C776AE9		





1/2" OVERLAY "D"		SELF-CLOSE								SOFT-CLOSE					
		94°		110°		120°		165°		105°		110°		155°	
		SKU	P/N	SKU	P/N	SKU	P/N	SKU	P/N	SKU	P/N	SKU	P/N	SKU	P/N
	Screw In 					HS2120DS	C2P9D99								
	Knock In 	HS2094DK	C2RBD99	HS2110DK	C2R6D99	HS2120DK	C2R9D99	HS2165DK	C2RFD99	HS1105DK+	C1R6DE9	HS7110DKSE	C7RDE9	HS2155DST+	C2RKDE9
	Logica 			HS2110DL	C2J6D99	HS2120DL	C2J9D99	HS2165DL	C2JFD99	HS1105DL+	C1J6DE9	HS7110DLSE	C7J6DE9		
	Rapido 			HS2110DR	C276D99	HS2120DR	C279D99	HS2165DR	C27FD99	HS1105DRS	C176DD9	HS7110DRSE	C776DE9		

HALF OVERLAY (3/8") "G"		SELF-CLOSE								SOFT-CLOSE					
		94°		110°		120°		165°		105°		110°		155°	
		SKU	P/N	SKU	P/N	SKU	P/N	SKU	P/N	SKU	P/N	SKU	P/N	SKU	P/N
	Screw In 														
	Knock In 			HS2110GK	C2R6G99	HS2120GK	C2R9G99	HS2165GK	C2RFG99			HS7110GKSG	C7RGE9	HS7155GKS	C2RKGE9
	Logica 			HS2110GL	C2J6G99	HS2120GL	C2J9G99			HS1105GL+	C1J6GE9	HS7110GLSE	C7J6GE9		
	Rapido 			HS2110GR	C276G99	HS2120GR	C279G99	HS2165GR	C27FG99	HS1105GR+	C176GE9	HS7110GRSE	C776GE9		

INSET "P"		SELF-CLOSE								SOFT-CLOSE					
		94°		110°		120°		165°		105°		110°		155°	
		SKU	P/N	SKU	P/N	SKU	P/N	SKU	P/N	SKU	P/N	SKU	P/N	SKU	P/N
	Screw In 														
	Knock In 	HS2094PK	C2RBP99	HS2110PK	C2R6P99			HS2165PK	C2RFP99			HS7110PKSE	C7R6PE9		
	Logica 			HS2110PL	C2J6P99										
	Rapido 														

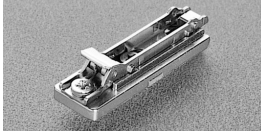
SALICE® SERIES 200 HINGE MOUNTING PLATES AND PIE CORNER HINGE KITS

	SCREW IN STEEL		SCREW IN DIE-CAST	
FACE FRAME PLATES				
	SINGLE CAM		DOUBLE CAM	
	SKU	P/N	SKU	P/N
1 MM	HSMP0265	BAU3L19	HSMP0270	BAU3R19
4 MM	HSMP0280	BAU3L49	HSMP0285	BAU3R49
INSET	HSMP0275	BAL3R59		
1-1/4" OVERLAY	HSMP0290	BAU3R09		

	WOOD SCREW DIE-CAST		EURO SCREW STEEL		WOOD SCREW STEEL		EURO SCREW DIE-CAST	
FRAMELESS PLATES								
	SINGLE CAM		SINGLE CAM		DOUBLE CAM		DOUBLE CAM	
	SKU	P/N	SKU	P/N	SKU	P/N	SKU	P/N
0 MM	HSMP0005	BAV3L09F	HSMP0020	BAVGL09F/16	HSMP0140	BAR3R09	HSMP0145	BARGR09/16
2 MM					HSMP0170	BAR3R29	HSMP0175	BARGR29/16
3 MM	HSMP0040	BAV3L39F	HSMP0055	BAVGL39F/16	HSMP0200	BAR3R39	HSMP0205	BARGR39/16
6 MM					HSMP0230	BAR3R69	HSMP0235	BARGR69/16
9 MM					HSMP0245	BAR3R99	HSMP0250	BARGR99/16
12 MM	HSMP0110	BAV3EC9F			HSMP0252	BAR3RC9		
18 MM					HSMP0260	BARGR99/16	HSMP0255	BARGRV9/16
24 MM					HSMP0262	BAR3RY9	HSMP0263	BARGRY9/16

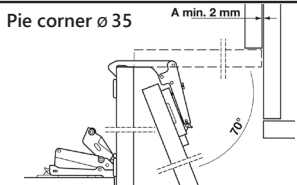
PIE CORNER HINGE KITS (1 Kit Per Door)		SELF-CLOSE		SOFT-CLOSE	
		1/2" OVERLAY		1/2" OVERLAY	
		SKU	P/N	SKU	P/N
		HS2PCFF1/2		HS2PCFS1/2	

SALICE® SERIES S FACE FRAME COMPACT HINGES - SELF & SOFT CLOSE



SALICE
excentra

Two Cam

Salice S Series Excentra: concealed cabinet hinge featuring zero door protrusion and is 2-way one-piece cam adjustable.

- Two fixing screws for ultimate security.
- 2-way adjustment via cam saves time on final adjustment.

2 CAM EXCENTRA 106		SELF-CLOSE									
		1/4"		1/2"		5/8"		3/4"		1-1/4"	
		SKU	P/N	SKU	P/N	SKU	P/N	SKU	P/N	SKU	P/N
	Screw In			HSS25S	CSP3799						
	Knock In	HSS05K	CSR3Y99	HSS25K	CSR3799	HSS35K	CSR3599	HSS40K	CSR3499		

2 CAM EXCENTRA 106		SOFT-CLOSE									
		1/4"		1/2"		5/8"		3/4"		1-1/4"	
		SKU	P/N	SKU	P/N	SKU	P/N	SKU	P/N	SKU	P/N
	Screw In			HSSE00012S	CUP37D9						
	Knock In			HSSE00012D	CUR37D9	HSSE00058D	CUR35D9				

SALICE
excentthree

Three Cam

Salice S Series Excentthree: concealed cabinet hinge featuring zero door protrusion and is 3-way one-piece cam adjustable.

- Two fixing screws for ultimate security.
- 3-way adjustment via cam saves time on final adjustment.

3 CAM EXCENTRA 106		SELF-CLOSE									
		1/4"		1/2"		5/8"		3/4"		1-1/4"	
		SKU	P/N	SKU	P/N	SKU	P/N	SKU	P/N	SKU	P/N
	Screw In			HSS25SXR	CSP3799XR						
	Knock In			HSS25KXR	CSR3799XR	HSS35KXR	CSR3599XR	HSS40KXR	CSR3499XR	HSS75KXR	CSR3A99NR

3 CAM EXCENTRA 106		SOFT-CLOSE									
		1/4"		1/2"		5/8"		3/4"		1-1/4"	
		SKU	P/N	SKU	P/N	SKU	P/N	SKU	P/N	SKU	P/N
	Screw In			HSSE30012S	CUP37D9R					HSSE30114S	CUP3AD9R
	Knock In			HSSE30012D	CUR37D9R			HSSE30034D	CUR34D9R	HSSE30114D	CUR3AD9R

AMANA TOOL® HINGE BORING BITS

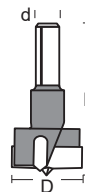

TA203351



TA301008



TOOL NUMBER	D	d	L
TA203351	35mm	10mm	57mm
TA301008	8mm	10mm	57mm

SALICE



SALICE® FUTURA SMOVE 7555	
TYPE	Full Extension, Soft-Close Drawer Slide
MOUNTING	Bottom
LOAD RATING	75 lbs. Dynamic, 100 lbs. Static
FINISH	Bright Zinc Plated
KEY FEATURES	<ul style="list-style-type: none"> • Smove decelerated closing mechanism • Handles up to 5/8" thick drawers • Lever disconnect

6 SETS PER CASE

SKU	LENGTH
HSA75559S	9"
HSA755512S	12"
HSA755515S	15"
HSA755518S	18"
HSA755521S	21"

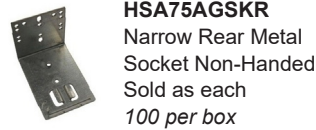
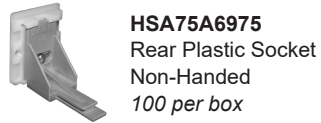
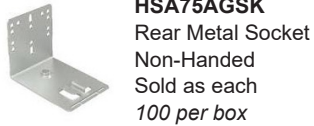

SALICE

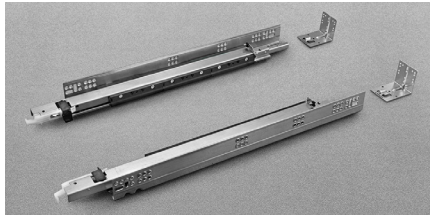

SALICE® F70 SMOVE	
TYPE	Full Extension, Soft-Close, Heavy Duty Drawer Slide
MOUNTING	Bottom
LOAD RATING	170 lbs.
FINISH	Bright Zinc Plated
KEY FEATURES	<ul style="list-style-type: none"> • Smove decelerated closing mechanism • Handles up to 5/8" thick drawers • Lever disconnect

6 SETS PER CASE

SKU	LENGTH
HSG70BS18F	18" Faceframe
HSG70BS21F	21" Faceframe
HSG70BS21	21"
HSG70BS24	24"
HSG70BS27	27"
HSG70BS30	30"

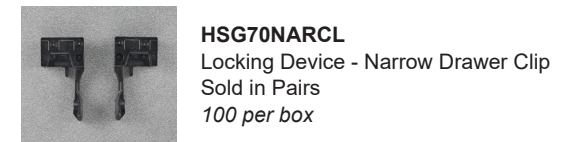
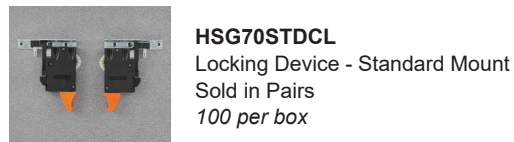

KV® MUV+	
TYPE	Full Extension, Soft-Close, Medium Duty Drawer Slide
MOUNTING	Bottom
LOAD RATING	75 lbs.
FINISH	Zinc
KEY FEATURES	<ul style="list-style-type: none"> • Integrated Soft-Close • Handles up to 5/8" thick drawers • Lever disconnect

6 SETS PER CASE

SKU	LENGTH
KVMUVPB18	18"
KVMUVPB21	21"



BALLBEARING DRAWER SLIDES



USA
Made

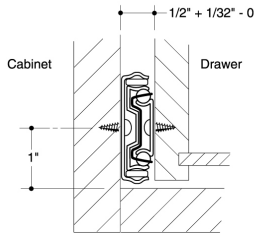

KV® 8400	
TYPE	Full Extension, Ball Bearing, Medium Duty Drawer Slide
MOUNTING	Side
LOAD RATING	100 lbs.
CLEARANCE	1/2" plus 1/32" minus 0" each side
FINISH	Anochrome (ANO)
KEY FEATURES	<ul style="list-style-type: none"> • Non-Handed Design • Lever disconnect

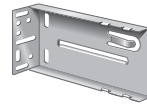

KV8402RMB
Rear Mounting Bracket - Fits all 8400 Series Slides
Order (2) for a set.
Sold as Each
20 per carton

10 SETS PER CASE

SKU	LENGTH
KV840008	8"
KV840010	10"
KV840012	12"
KV840014	14"
KV840016	16"
KV840018	18"
KV840020	20"
KV840022	22"

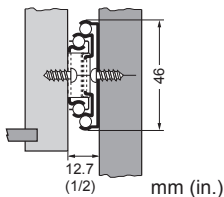
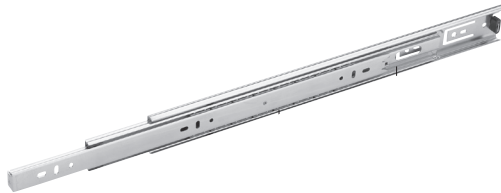

12.7 mm (0.5 in.) is the actual size of the slide.
Allow a min. of 13.1 mm (0.52 in.) for clearance.

FULTERER® FR 5000	
TYPE	Full Extension, Ball Bearing Drawer Slide - Standard
MOUNTING	Side
LOAD RATING	100 lbs. (dynamic)
CLEARANCE	12.7mm
FINISH	Zinc
KEY FEATURES	<ul style="list-style-type: none"> • Non-Handed Design • Lever disconnect • Hold-Closed Detent

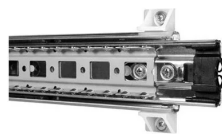

FFR5000FMP
Front Mounting
Bracket Face Frame, Plastic
100 per carton



FFR5000RMP
Rear Mounting
Bracket w/ Plastic
100 per carton

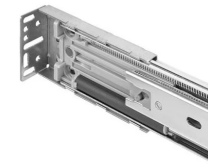

FFR5000RMM
Rear Mounting
Bracket, Metal
200 per carton

10 SETS PER CASE

SKU	LENGTH
FFR500008	8"
FFR500010	10"
FFR500012	12"
FFR500014	14"
FFR500016	16"
FFR500018	18"
FFR500020	20"
FFR500022	22"
FFR500024	24"
FFR500026	26"

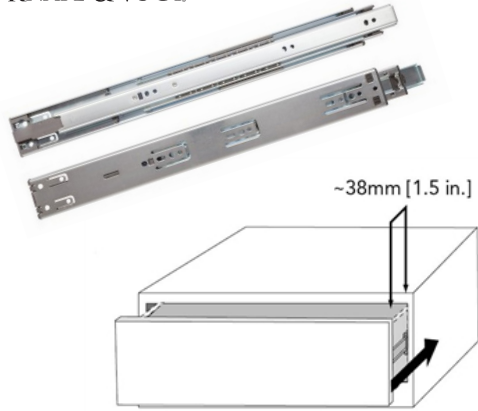

As the drawer closes, the soft-close mechanism engages and guides the drawer to a soft, secure, and non-rebounding finish.

KV® GS4270	
TYPE	Ball Bearing, Telescopic, Medium Duty, Soft-Close Drawer Slide
MOUNTING	Side
LOAD RATING	100 lbs.
CLEARANCE	1/2" plus 1/32" minus 0" each side
FINISH	Zinc
KEY FEATURES	<ul style="list-style-type: none"> • Non-Handed Design • Soft-Close Design



KVGS4340RB
Rear Mounting Braclet, Metal
Order (2) for a set.
200 per case

10 SETS PER CASE

SKU	LENGTH
KVGS427012	12"
KVGS427014	14"
KVGS427016	16"
KVGS427018	18"
KVGS427020	20"
KVGS427022	22"
KVGS427024	24"
KVGS427026	26"
KVGS427028	28"



USA Made

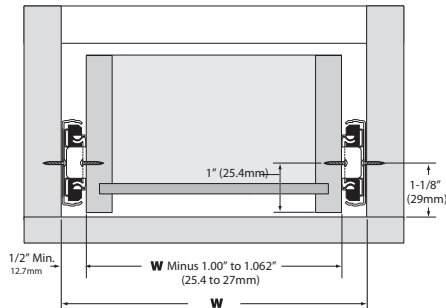

KV® 8450FM	
TYPE	Full Extension Ball Bearing, Telescopic, Soft-Close Drawer Slide
MOUNTING	Side
LOAD RATING	100 lbs.
CLEARANCE	1/2" plus 1/32" minus 0" each side
FINISH	Anochrome (ANO)
KEY FEATURES	<ul style="list-style-type: none"> • Non-Handed Design • Soft-Close Design

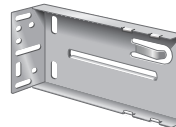

KV8403RMB
Rear Mounting Braclet
Non-handed snap-on design
2-3/4" max adjustment
Fits all 8400 Series Slides
20 per case

10 SETS PER CASE

SKU	LENGTH
KV8450FM12	12"
KV8450FM14	14"
KV8450FM16	16"
KV8450FM18	18"
KV8450FM20	20"
KV8450FM22	22"
KV8450FM24	24"
KV8450FM26	26"
KV8450FM28	28"

BALLBEARING SOFT CLOSE DRAWER SLIDES

Fulterer Drawerslide Systems™

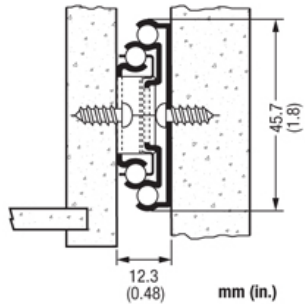

12.3 mm (0.48 in.) is the actual size of the slide. Allow a min. of 12.8 mm (0.50 in.) for clearance and a maximum of 13.3 mm (0.52 in.).

FULTERER® FR 5001.ECD	
TYPE	Full Extension, Ball Bearing, Easy-Close Drawer Slide
MOUNTING	Side
LOAD RATING	100 lbs.
CLEARANCE	12.3 mm
FINISH	Zinc
KEY FEATURES	<ul style="list-style-type: none"> • Non-Handed Design • Lever disconnect • Soft-Closed Design

10 SETS PER CASE

SKU	LENGTH
FFR5-ECD12	12"
FFR5-ECD14	14"
FFR5-ECD16	16"
FFR5-ECD18	18"
FFR5-ECD20	20"
FFR5-ECD22	22"
FFR5-ECD24	24"
FFR5-ECD26	26"
FFR5-ECD28	28"

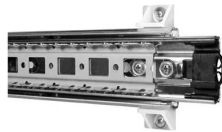

FFR5000FMP
Front Mounting
Bracket Face Frame, Plastic
100 per carton



FFR5000RMP
Rear Mounting
Bracket w/ Plastic
100 per carton

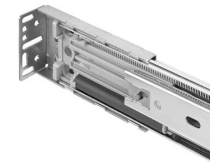

FFR5000RMM
Rear Mounting
Bracket, Metal
200 per carton

SALICE



SALICE® 208	
TYPE	3/4 Extension, Self-Close Drawer Slide w/ Rollers
MOUNTING	Side
LOAD RATING	75 lbs. (Dynamic)
FINISH	White (WH)
KEY FEATURES	<ul style="list-style-type: none"> • Double Safety to Prevent Pull-Out • Lift Out Disconnect • Self-Close Design

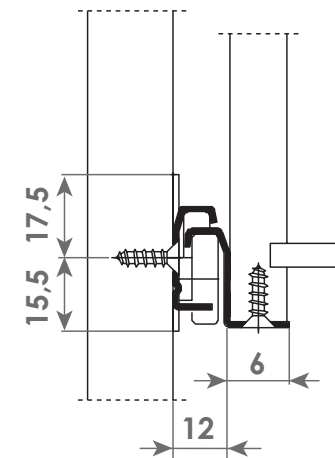

25 SETS PER CASE

SKU	Length
HSA20812WI	12"
HSA20814WI	14"
HSA20816WI	16"
HSA20818WI	18"
HSA20820WI	20"
HSA20822WI	22"
HSA20824WI	24"

SOLD ONLY IN SETS OF 100 PER CASE

SKU	Length
HSA20818WB	18"
HSA20820WB	20"
HSA20822WB	22"

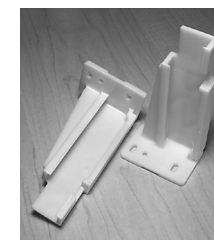

HSA208S0KL
HSA208S0KR
 Left & Right Handed Sockets
 100 per box per side



KV® 1805	
TYPE	3/4 Extension Self-Close, Euro Drawer w/ Rollers
MOUNTING	Side
LOAD RATING	75 lbs.
CLEARANCE	12.5mm (1/2") plus .8mm (1/32") minus 0"
FINISH	White (WH)
KEY FEATURES	<ul style="list-style-type: none"> • 32mm Mounting Hole Pattern • Lift Out Disconnect • Self-Close Design

20 SETS PER CASE

SKU	LENGTH
KV1805T12	12"
KV1805T14	14"
KV1805T16	16"
KV1805T18	18"
KV1805T20	20"
KV1805T22	22"
KV1805T24	24"

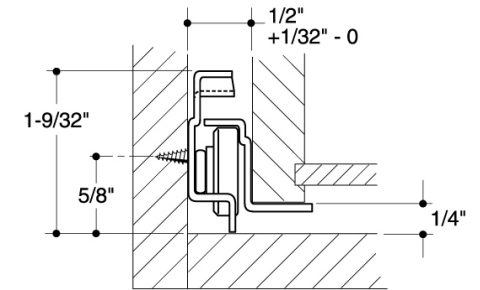

1284, 1285



Q-PACKS - SOLD ONLY IN SET OF 100 PER CASE

SKU	LENGTH
KV1805Q12	12"
KV1805Q14	14"
KV1805Q16	16"
KV1805Q18	18"
KV1805Q20	20"
KV1805Q22	22"

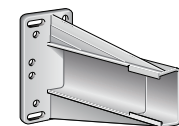

KV1805-101L
KV1805-101R
 Left & Right Handed Sockets
 2-3/8" Socket
 Case = 50 per side

