



**Amerock®**

DESIGN  
*obsession*

---

SPOTLIGHT CATALOG



welcome

*Opposite page:*

1. New coordinating bath accessories to Glacio (p. 46)
2. New coordinating bath accessories to Mulholland (p. 78)
3. Concentric (p. 60)
4. Carrione (p. 48)
5. Blackrock (p. 28)



*to our home*

## Artfully **evolving.**

As the demands and aspirations of the homeowner have evolved, **so have we.** For **more than 90 years,** Amerock has created moments of **beauty** where they are least expected and allowed homeowners to express their **personal style.**



## Investing in *you.*

**An Amerock CEU:**  
Choosing Decorative Hardware  
for Your Kitchen & Bath



Scan to **request this CEU event** and earn credits.



**CEU Approved & Recognized by:**



Our creative *evolution* continues.

**Step inside.** Find inspiration to turn ideas into beautiful realities with Amerock's best and brightest collections.

Inspiration Awaits	
Trend-Inspired Finishes & Styles	6
<i>Complementing Finishes:</i>	
Plumbing & Lighting	8
Door Hardware	10
Color Pairings & Design Tips	12
ADA-Friendly Items	14

Kitchen: Heart of the Home	16
Dual-Purpose Spaces	18
Bath: A Personal Oasis	20
Think Outside the Kitchen & Bath	22
Hooks: Organization Elevated	24
Transitional	
Blackrock	28
Davenport	30
Highland Ridge	32
<i>new!</i> Overton	34
Westerly	36
Kane	38
Candler	40
Rochdale	42



**House Beautiful**

*Recognized for its artistic flair in mixed materials.*

*Carrione (p. 48)*



**TRADITIONAL HOME.**

*Napa Valley Showhouse kitchen by Marie Flanigan Interiors.*

*Highland Ridge (p. 32)*

# Contents

## Contemporary 44

Glacio	46
Carrione	48
St. Vincent	50
London	52
Esquire	54
<i>new!</i> Bronx	56
Oberon	58
<i>new!</i> Concentric	60
<i>new!</i> Calathea	62
<i>new!</i> Kamari	64
<i>new!</i> Urbanite	66
<i>new!</i> Transcendent	68
Bar Pulls	70
Bar Pulls (Hollow)	72
Cyprus	74

## Traditional 76

Mulholland	78
Revitalize	80
Ashby	82
Grace Revitalize	84
Sea Grass	86

## Merchandising Options 88

### Key Software Partnerships: How to Find Amerock

2020 Design	92
Envision	93

## Product Index 94

Style with *confidence.*



Amerock voted most popular  
by the Houzz community.

*Shown: Blackrock (p. 28)*



Amerock has won  
consecutively since 2013.

*Shown: Glacio (p. 46)*

# finishing touches

## Meet your **match.**

Amerock's trend-inspired **styles and finishes** are designed to complement **popular plumbing and lighting brands**, so you can easily tie the whole look together.



**Golden Champagne**  
by Amerock  
*Highland Ridge (p. 32)*



**Vibrant Brushed Bronze**  
by Kohler



**Brushed Bronze**  
*(Similar Complement)*  
by Progress Lighting



**CARRIONE**

p. 48

*Paired with Arrondi  
Bath Accessories*



**Satin Brass**  
by Emtok

# Complementing Finishes:

## Plumbing & Lighting + Amerock Finish

Seamlessly tie the whole look together with these suggested **finish companions**.

			
<b>AMEROCK</b> Cabinet Hardware	Polished Chrome	Polished Nickel	Satin Nickel
<b>AMEROCK</b> Bath Accessories	Chrome	Polished Nickel	Brushed Nickel
<b>BRIZO</b>	Polished Chrome	—	Brushed Nickel
 <b>DELTA</b>	Chrome	Polished Nickel	Stainless
<b>KOHLER</b>	Polished Chrome	Vibrant Polished Nickel	Vibrant Brushed Nickel
 <b>MOEN</b>	Chrome	Polished Nickel	Brushed Nickel
<b>ROHL</b>	Polished Chrome	Polished Nickel	Satin Nickel
 <b>KICHLER</b>	Chrome	Polished Nickel	Brushed Nickel
<b>PROGRESS LIGHTING</b>	Polished Chrome	Polished Nickel	Brushed Nickel





**Golden Champagne**



**Champagne Bronze**

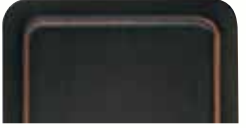

**Oil-Rubbed Bronze**



**Black Bronze  
Matte Black**

Golden Champagne	Champagne Bronze	Oil-Rubbed Bronze	Matte Black
Luxe Gold <i>(Similar Complement)</i>	Luxe Gold <i>(Closest Companion)</i>	Venetian Bronze	Matte Black
Champagne Bronze <i>(Similar Complement)</i>	Champagne Bronze <i>(Closest Companion)</i>	Oil-Rubbed Bronze	Matte Black
Vibrant Brushed Bronze	Vibrant Brushed Moderne Brass	Oil-Rubbed Bronze	Matte Black
Brushed Gold <i>(Similar Complement)</i>	Brushed Gold <i>(Closest Companion)</i>	Oil-Rubbed Bronze	Matte Black
Satin English Gold <i>(Closest Companion)</i>	Satin English Gold <i>(Similar Complement)</i>	—	Matte Black
—	—	Olde Bronze	Black
Brushed Bronze <i>(Similar Complement)</i>	Brushed Bronze <i>(Closest Companion)</i>	Antique Bronze	Matte Black

Finishes subject to change and may appear different in person than in printed material. ©2022

# Complementing Finishes:

## Door Hardware + Amerock Finish

Seamlessly tie the whole look together with these suggested **finish companions**.



**GLACIO**  
p. 46

Looking for a *seamless* pairing?



**Golden Champagne**  
by Amerock

*Blackrock (p. 28)*

**Satin Brass**  
by Emtek



**Polished Chrome**



**Polished Nickel**



**Satin Nickel**

**AMEROCK**  
Cabinet Hardware

**AMEROCK**  
Bath Accessories



**BALDWIN**

Polished Chrome

Polished Nickel

Satin Nickel

Door Hardware

**EMTEK**

Polished Chrome

Polished Nickel

Satin Nickel



ESQUIRE  
p. 54

## expert tips

Reimagine the look with a variety of pull lengths.

Follow this **general rule**...



1/2 or Less of  
Drawer Width

1/3 or Less of  
Door Height

...or go *even longer*  
for a dramatic look.



Golden Champagne



Champagne Bronze



Oil-Rubbed Bronze



Black Bronze  
Matte Black

Golden Champagne

Champagne Bronze

Oil-Rubbed Bronze

Matte Black

Vintage Brass

—

Venetian Bronze

Satin Black

Satin Brass

—

Oil-Rubbed Bronze

Flat Black

Finishes subject to change and may appear different in person than in printed material. ©2022

# nature's hues

## Bring the **outdoors** in.

Rooted in nature, today's palettes are all about creating a **serene, welcoming** space. Metallic finishes are the **perfect touch** to **complete** these nature-inspired palettes.

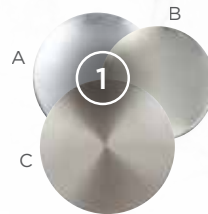

### **SILVER TONES** Unexpected sparkle.

- A. Polished Chrome
- B. Polished Nickel
- C. Satin Nickel

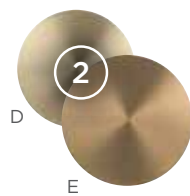

### **GOLD TONES** Sunny glow.

- D. Golden Champagne
- E. Champagne Bronze



### **DARK TONES** Understated drama.

- F. Oil-Rubbed Bronze
- G. Matte Black or Black Bronze

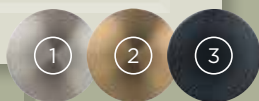

## Green has *arrived*.

From **understated shades** to **adventurous color pops**, greens of all kinds are taking center stage.



- 1
- 2

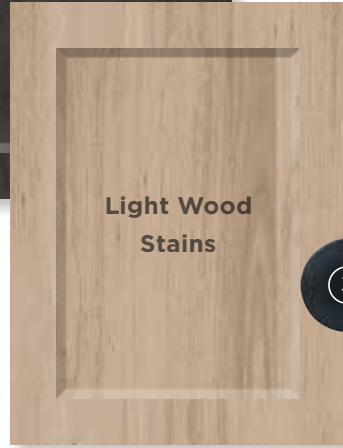

- 3

## Natural *woodtones.*

It's no secret organic materials provide inviting warmth. Here are **a few suggested finish companions** for today's neutral coffee stains.

## Ever-changing *neutrals.*

With their nuanced undertones, **today's evolving grays and white tones** bring rich hues into the home while **still capturing a harmonious look.**

### WIDE OPEN POSSIBILITIES

The beauty of neutrals is in their versatility to work with **virtually any finish or style.**



# planning ahead

## Aging **in place.**

Growing with the **evolving needs of homeowners**, Amerock keeps **accessibility** and **ergonomics** in mind with meticulous attention to **thoughtful design.**



Our **ADA-Friendly** pulls feature the clearance necessary, based on the Dreyfuss Human Factor Scale, to accommodate the hand of an average man. They are **U-shaped, easy to grip** and **don't require tight grasping, pinching or twisting**, as prescribed in Section 309.4 of the ADA Accessibility Guidelines (ADAAG).

## Just a sampling: ADA-Friendly items featured in this catalog.



Scan to **view the full breadth** of Amerock's ADA-Friendly items.



**Blackrock**

*p. 28*



**Highland Ridge**

*p. 32*



**Westerly**

*p. 36*

**3in (76mm) CTC**

•

•

•

Pulls

**3-3/4in (96mm) CTC**

✓ BP55276

✓ BP55317

✓ BP53720

**5-1/16in (128mm) CTC**

✓ BP55277

✓ BP55319

✓ BP53721

**6-5/16in (160mm) CTC**

✓ BP55278

✓ BP55321

✓ BP53722

Appliance  
Pulls

**8in (203mm) CTC**

✓ BP55279

✓ BP55322

—

**12in (305mm) CTC**

✓ BP55280

✓ BP55323

✓ BP54023

**18in (457mm) CTC**

✓ BP55281

✓ BP55324

✓ BP54024



## The perfect touch.

### FREE SAMPLES PROGRAM

It's **easy** to find the right size, style and finish for **every project**.

Contact your Amerock sales rep for details.



**Kane**

*p. 38*



**Candler**

*p. 40*



**Rochdale**

*p. 42*



**Calathea**

*p. 62*



**Mulholland**

*p. 78*



**Revitalize**

*p. 80*

Kane	Candler	Rochdale	Calathea	Mulholland	Revitalize
•	•	•	—	•	•
✓ BP53702	✓ BP29355	✓ BP53712	✓ BP100396	✓ BP53031	✓ BP55344
✓ BP53802	✓ BP29363	✓ BP53713	✓ BP1003128	✓ BP53529	✓ BP55346
✓ BP53803	✓ BP29364	✓ BP53714	✓ BP1003160	✓ BP53530	✓ BP55347
✓ BP53804	✓ BP29365	—	—	✓ BP53531	✓ BP55348
✓ BP53805	✓ BP29366	—	—	✓ BP53532	✓ BP55349
✓ BP53806	✓ BP29367	—	—	✓ BP53533	✓ BP55350

# heart of the home

## A canvas of possibilities.

The kitchen is where it **all comes together**. It's the **heavy-lifter** that serves the evolving needs of the family. Give this gathering space the **beauty, form** and **function** it needs with the **perfect mix of details**.

Delight in the *dramatic* as the kitchen comes to life.

### CREATING THAT WOW-FACTOR

The accent island goes even bolder with **contrasting hardware**.

CARRIONE  
p. 48

LILY

by Visual Comfort

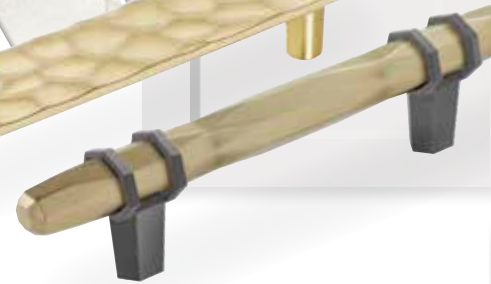
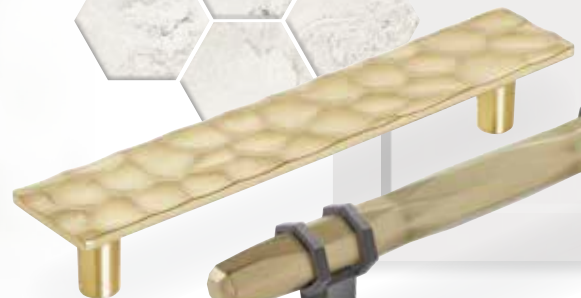

*new!*

KAMARI  
p. 64

LONDON  
p. 52

### ANYTHING BUT ORDINARY

**Just like lighting**, cabinet hardware can be the **perfect statement piece** on a neutral backdrop.



Trend on the rise:

*modern  
farmhouse*

DAVENPORT  
*p. 30*

HIGHLAND  
RIDGE  
*p. 32*

Highland Ridge  
AS SEEN IN

TRADITIONAL HOME.

# playing dual roles

## Delight in the unexpected.

With more homeowners seeking **dual-purpose spaces adjacent to the kitchen**, a cascade of possibilities opens. Create **unexpected statement pieces** in these nearby spaces with styles that complement those in the kitchen.

Dual-purpose doesn't have to be *ho-hum*.

Beauty in the butler's pantry.



DAVENPORT  
+ OBERON

p. 30 & 58

Carving out a home office nook.



REVITALIZE +  
GRACE REVITALIZE

p. 80 & 84

*matches*



Powder room  
*pageantry.*



SEA GRASS +  
CRAWFORD

p. 86

*made in heaven*

# creating calm

## A personal oasis.

Tailored to every need, a **smoothly functioning bath space** is where the homeowner prepares for a successful day and a restful evening.



**RENSLOW**  
*by Kichler*

**PURIST**  
*by Kohler*

### THE SPA-INSPIRED BATH SPACE

Creating calm is all in the **right mix of details.**

**REVITALIZE**  
*p. 80*

*Paired with Coordinating Bath Accessories*

## A beautiful retreat that simply works.

### LIMITED WALL SPACE

**Versatile options** for small yet mighty bathrooms.



**ESQUIRE & MULHOLLAND**

*p. 54 & 78*

*Coordinating Bath Accessories*





**ESQUIRE**

p. 54

Paired with Coordinating  
Bath Accessories

Complete the *look.*

**COORDINATING  
BATH ACCESSORIES**

*12* new  
collections.



**DAVENPORT  
& GLACIO**

p. 30 & 46

Coordinating  
Bath Accessories

# elevating the ordinary

## Think **outside** the kitchen and bath.

The home is a reflection of the homeowner, and no space should be overlooked. **Versatile finishing touches** elevate even utilitarian spaces such as **entryways, closets** and **laundry rooms** from ordinary to bespoke.

ST. VINCENT

p. 50

Coordinating Hook

*new!*

CALATHEA

p. 62





ESQUIRE  
p. 54

*Paired with Coordinating Hook*

# the right ingredients

## Organization **elevated.**

Home organization **has never been so stylish.** Tailor the look from start to finish with **versatile new hooks** that complement popular styles and finishes in **plumbing, lighting** and **door hardware.**

### Davenport

*Hook + Coordinating Cabinet Hardware*  
p. 30



2

### Glacio

*Hook + Coordinating Cabinet Hardware*  
p. 46



1

### Bronx

*Hook + Coordinating Cabinet Hardware*  
p. 56



3

### Esquire

*Single Hook + Coordinating Cabinet Hardware*  
p. 54  
*Double hook also available.*



4

*available finishes*



- 1. 2-15/16in (75mm) LGTH - BH36060
- 2. 2-15/16in (75mm) LGTH - BH36050

- 3. 2-11/16in (68mm) LGTH - BH36563
- 4. 2-11/16in (68mm) LGTH - BH36563



## Blackrock

Hook + Coordinating  
Cabinet Hardware  
p. 28



5

## St. Vincent

Hook + Coordinating  
Cabinet Hardware  
p. 50

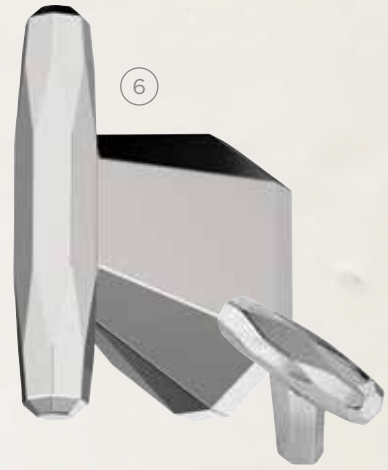

6

## Revitalize

Hook + Coordinating  
Cabinet Hardware  
p. 80



7

## Mulholland

Hook + Coordinating  
Cabinet Hardware  
p. 78

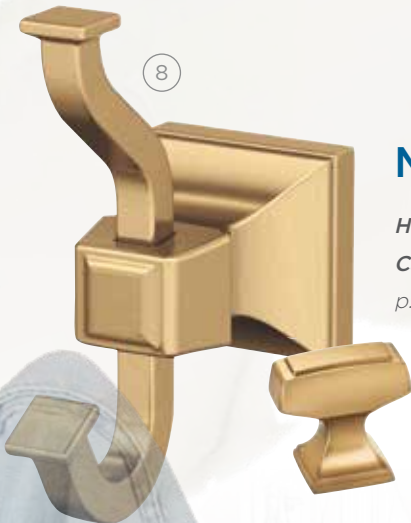

8

## Highland Ridge

Hook + Coordinating  
Cabinet Hardware  
p. 32



9

More styles that *elevate* the everyday.

Contact your Amerock  
sales rep to learn more.

10



## Arrondi

p. 158

11



## Stature

p. 159

12



## Appoint

p. 158

13



## Monument

p. 158

5. 3-9/16in (90mm) LGTH - BH36000

6. 3-7/16in (87mm) LGTH - BH36040

7. 2-1/8in (54mm) LGTH - BH36030

8. 4-1/4in (108mm) LGTH - BH36020

9. 2-5/8in (67mm) LGTH - BH36010

10. 2-1/4in (57mm) LGTH - BH26542

11. 2-1/4in (57mm) LGTH - BH36090

12. 1-7/8in (48mm) LGTH - BH36070

13. 7/8in (22mm) LGTH - BH36080



# transitional

Blackrock	28
Davenport	30
Highland Ridge	32
<i>new!</i> Overton	34
Westerly	36
Kane	38
Candler	40
Rochdale	42



4

1. Highland Ridge
2. Blackrock
3. Davenport
4. Kane

## AVAILABLE FINISHES



**New!**

**Polished Chrome**  
(26)

**Polished Nickel**  
(PN)

**Satin Nickel**  
(G10)

**Golden Champagne**  
(BBZ)

**New!**

**Champagne Bronze**  
(CZ)

**Oil-Rubbed Bronze**  
(ORB)

**Gunmetal**  
(GM)

**Black Bronze**  
(BBR)  
*Comparable to Matte Black*

 **ADA**  
FRIENDLY

- Pulls longer than 3in (76mm) CTC
- Appliance Pulls

## STAY-PUT PLACEMENT

Small spikes on the base help ensure knobs won't rotate from the **desired orientation**.

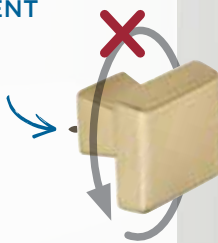

Love the look:  
**A punch of gold.**

Blackrock in **Champagne Bronze** on crisp white cabinets



# Blackrock

## KNOBS (4 Sizes)

-  **A** 1-5/16in (33mm) DIA - BP55270
-  **B** 1-5/8in (41mm) DIA - BP55272
- C** 1-3/16in (30mm) LGTH - BP55271
- D** 1-1/2in (38mm) LGTH - BP55273

## PENDANT

-  **A** 1-13/16in (46mm) LGTH - BP55274

## PULLS (4 Sizes)

-  **A** 3-3/4in (96mm) LGTH  
3in (76mm) CTC - BP55275
- B** 4-5/8in (117mm) LGTH  
3-3/4in (96mm) CTC - BP55276  
*ADA-Friendly item.*
- C** 5-15/16in (151mm) LGTH  
5-1/16in (128mm) CTC - BP55277  
*ADA-Friendly item.*
- D** 7-1/4in (184mm) LGTH  
6-5/16in (160mm) CTC - BP55278  
*ADA-Friendly item.*

## APPLIANCE PULLS (3 Sizes)

-  **A** 9-3/8in (238mm) LGTH  
8in (203mm) CTC - BP55279\*  
*ADA-Friendly item.*
- B** 13-5/16in (338mm) LGTH  
12in (305mm) CTC - BP55280\*  
*ADA-Friendly item.*
- C** 19-3/8in (492mm) LGTH  
18in (457mm) CTC - BP55281\*  
*ADA-Friendly item.*

\* Not available in 26, CZ or GM.

SKU-specific details & hardware included p. 97-101



Finishes shown above:  
1. BBZ 2. BBR

perfect style pairings



**ZURA**  
by Delta

**BERGEN**  
by Currey & Company



*new!*  
**Coordinating Hook** p. 97  
3-9/16in (90mm) LGTH  
BH36000



*new!*  
**BLACKROCK**

Amerock Bath Accessories  
Shown in Matte Black

## AVAILABLE FINISHES



**New!**

**Polished Chrome**  
(26)

**Satin Nickel**  
(G10)

**New!**

**Golden Champagne**  
(BBZ)

**New!**

**Champagne Bronze**  
(CZ)

**Oil-Rubbed Bronze**  
(ORB)

**Gunmetal**  
(GM)

**New!**

**Matte Black**  
(MB) (FB)

## STAY-PUT PLACEMENT

Small spikes on the base help ensure knobs won't rotate from the **desired orientation**.

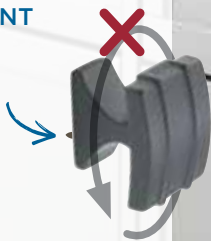

Love the look:  
**Monochrome masterpiece.**

Davenport in **Matte Black**  
against silvery neutrals



# Davenport

## KNOBS (2 Sizes)



- A 1-1/4in (32mm) LGTH - BP36601
- B 1-1/2in (38mm) LGTH - BP36602

## PULLS (4 Sizes)



- A 4-1/2in (114mm) LGTH **New!**  
3in (76mm) CTC - BP36600
- B 5-5/16in (135mm) LGTH  
3-3/4in (96mm) CTC - BP36605
- C 6-9/16in (167mm) LGTH  
5-1/16in (128mm) CTC - BP36606
- C 7-13/16in (198mm) LGTH  
6-5/16in (160mm) CTC - BP36607

SKU-specific details & hardware included p. 101-103



Finishes shown above:  
1. G10 2. GM

## FINISH COMPANIONS

Our **Gunmetal** complements popular **black stainless** appliance finishes.



GE's Black Stainless & LG's Black Stainless Steel

perfect style pairings

*new!*  
**Coordinating Hook** p. 101  
2-15/16in (75mm) LGTH  
BH36050

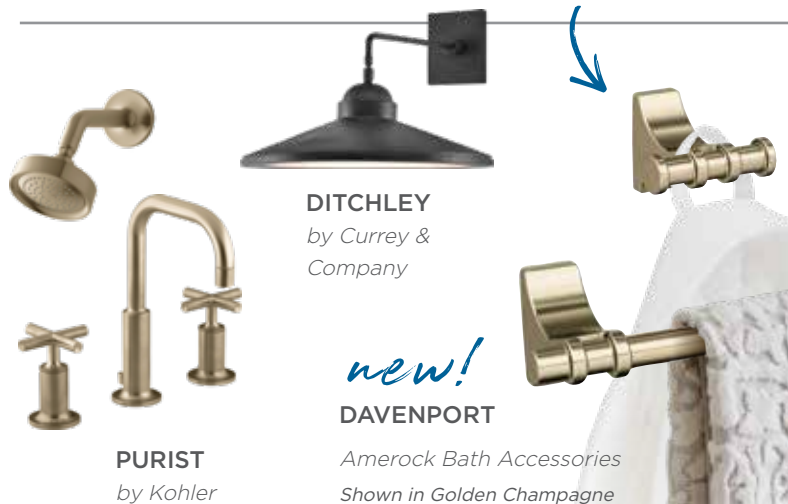

**DITCHLEY**  
by Currey & Company

**PURIST**  
by Kohler

*new!*  
**DAVENPORT**  
Amerock Bath Accessories  
Shown in Golden Champagne

## AVAILABLE FINISHES

**New!**

**Polished Chrome**  
(26)

**Polished Nickel**  
(PN)

**Satin Nickel**  
(G10)

**Aged Pewter**  
(AP)

**Golden Champagne**  
(BBZ)

**New!**

**Champagne Bronze**  
(CZ)

**Dark-Oiled Bronze**  
(DOB)  
*Comparable to Oil-Rubbed Bronze*

**Black Bronze**  
(BBR)  
*Comparable to Matte Black*

## STAY-PUT PLACEMENT

Small spikes on the base help ensure knobs won't rotate from the **desired orientation**.

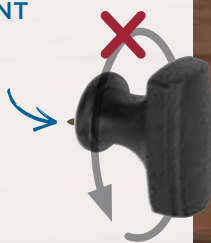

Love the look:  
**Modern farmhouse.**

Highland Ridge in  
**Black Bronze** on  
cream cabinets



- Pulls longer than 3in (76mm) CTC
- Appliance Pulls

AS SEEN IN

TRADITIONAL HOME.



# Highland Ridge

## KNOBS



- A** 1-3/16in (30mm) DIA - BP55312
- B** 1-3/8in (35mm) LGTH - BP55311

## PULLS (4 Sizes)



- A** 4-5/16in (110mm) LGTH  
3in (76mm) CTC - BP55316
- B** 5-3/16in (132mm) LGTH  
3-3/4in (96mm) CTC - BP55317  
*ADA-Friendly item.*
- C** 6-5/8in (168mm) LGTH  
5-1/16in (128mm) CTC - BP55319  
*ADA-Friendly item.*
- D** 8-9/16in (217mm) LGTH  
6-5/16in (160mm) CTC - BP55321  
*ADA-Friendly item.*



Finishes  
shown above:  
1. PN 2. BBZ

## CUP PULL



- A** 4in (102mm) LGTH  
3-1/2in (89mm) CTC - BP55318

## LATCH



- A** 1-7/8in (48mm) LGTH - BP55315\*

## APPLIANCE PULLS (3 Sizes)



- A** 10-7/16in (265mm) LGTH  
8in (203mm) CTC - BP55322\*\*  
*ADA-Friendly item.*
- B** 15-5/16in (389mm) LGTH  
12in (305mm) CTC - BP55323\*\*  
*ADA-Friendly item.*
- C** 20-7/8in (530mm) LGTH  
18in (457mm) CTC - BP55324\*\*  
*ADA-Friendly item.*

perfect style pairings

*new!*  
**Coordinating Hook** p. 103  
2-5/8in (67mm) LGTH  
BH36010

**BRINLEY**  
by Kichler



**COLINET**  
by Moen



*new!*

**HIGHLAND RIDGE**

Amerock Bath Accessories  
Shown in Brushed Nickel



\* Only available in PN, AP & DOB.

\*\* Not available in 26 or CZ.

SKU-specific details & hardware  
included p. 103-107

## AVAILABLE FINISHES

### Body/Posts



Satin Nickel/

Polished Chrome  
(G1026)



**New!**

Brushed Gold/

Satin Nickel  
(BGLG10)

Black Chrome  
(BGLBCR)



Black Chrome/

**New!**

Brushed Gold  
(BCRBGL)



**New!**

Brushed Matte Black/

Satin Nickel  
(BMBG10)

**New!**

Brushed Gold  
(BMBBGL)

Love the look:  
**Earthy elegance.**

Overton in **Brushed Matte  
Black/Brushed Gold**  
on slate cabinets

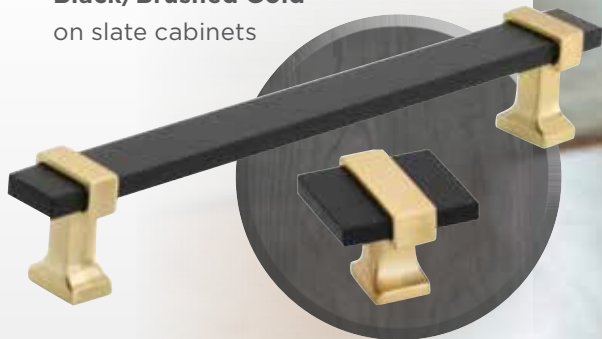

# new! Overton

## KNOB



- A 1-3/8in (35mm) LGTH - BP36680

## PULLS (5 Sizes)



- A 4-15/16in (125mm) LGTH  
3-3/4in (96mm) CTC - BP36681
- B 6-3/16in (157mm) LGTH  
5-1/16in (128mm) CTC - BP36682
- C 7-7/16in (189mm) LGTH  
6-5/16in (160mm) CTC - BP36683
- D 9-15/16in (252mm) LGTH  
8-13/16in (224mm) CTC - BP36684
- E 12-7/16in (316mm) LGTH  
11-5/16in (288mm) CTC - BP36685

SKU-specific details & hardware included p. 107-109

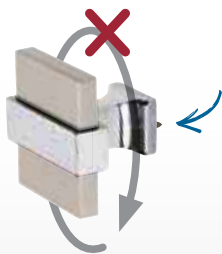

### STAY-PUT PLACEMENT

Small spikes on the base help ensure knobs won't rotate from the **desired orientation**.

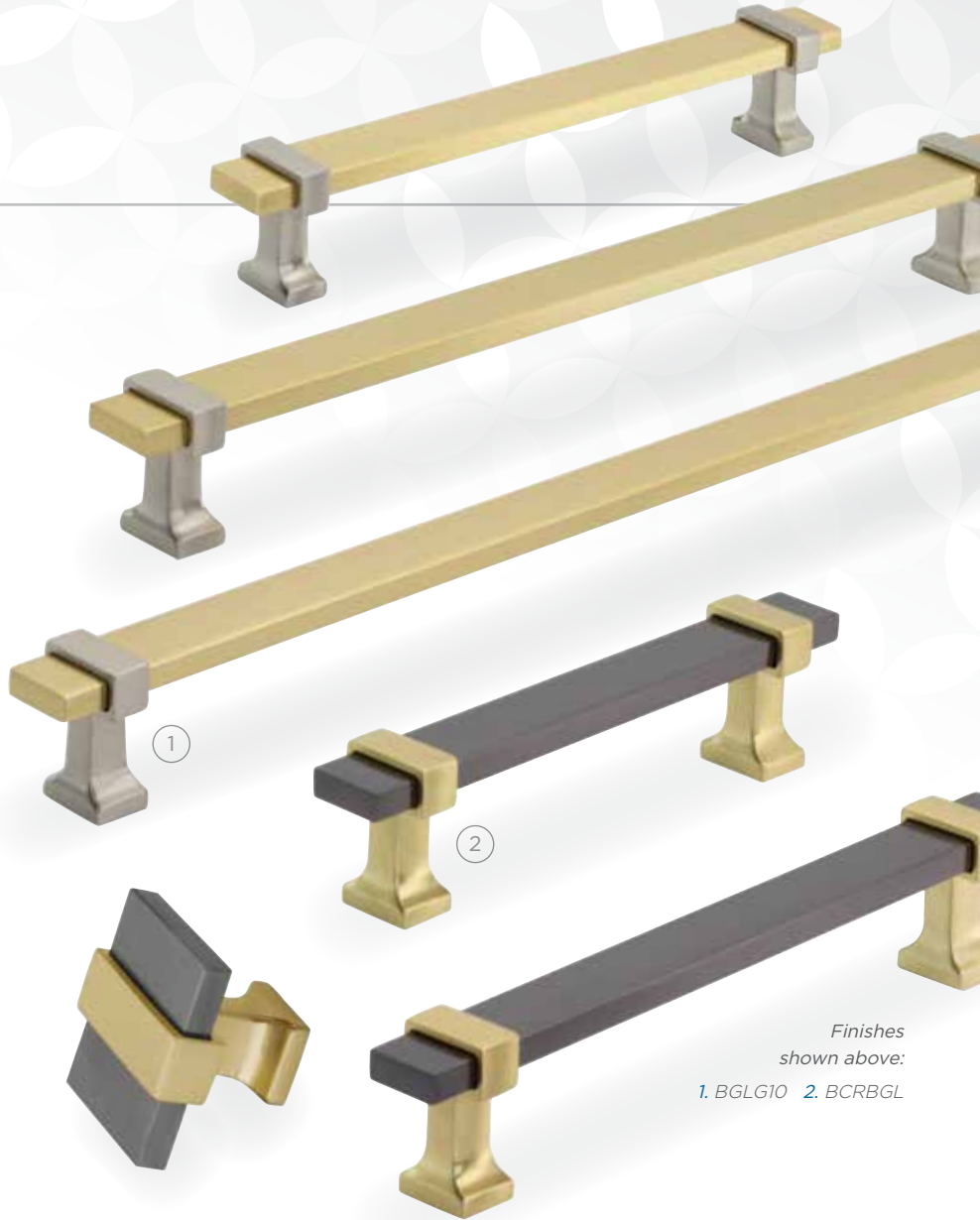

Finishes shown above:  
1. BGLG10 2. BCRBGL

### perfect style pairings



**DOUX**  
by Moen

**HARMON**  
by Currey & Company



new!  
**Coordinating Hook** p. 97  
3-9/16in (90mm) LGTH  
BH36000

new!  
**BLACKROCK**

Amerock Bath Accessories  
Shown in Matte Black



## AVAILABLE FINISHES



**Polished Nickel**  
(PN)

**Satin Nickel**  
(G10)

**Golden Champagne**  
(BBZ)

**Oil-Rubbed Bronze**  
(ORB)

**Graphite**  
(GPH)

**Black Bronze**  
(BBR)  
*Comparable to Matte Black*



- Pulls longer than 3in (76mm) CTC
- Appliance Pulls

## STAY-PUT PLACEMENT

Small spikes on the base help ensure knobs won't rotate from the **desired orientation**.



Love the look:  
**Two-tone elegance.**

Westerly in **Satin Nickel & Graphite** on snowy white cabinets



# Westerly

## KNOBS



- A** 1-5/16in (33mm) LGTH - BP53717
- B** 1-3/16in (30mm) DIA - BP53718

## PULLS (4 Sizes)

- A** 4-1/4in (108mm) LGTH  
3in (76mm) CTC - BP53719
- B** 5-1/16in (128mm) LGTH  
3-3/4in (96mm) CTC - BP53720  
*ADA-Friendly item.*
- C** 6-1/4in (159mm) LGTH  
5-1/16in (128mm) CTC - BP53721  
*ADA-Friendly item.*
- D** 7-9/16in (192mm) LGTH  
6-5/16in (160mm) CTC - BP53722  
*ADA-Friendly item.*

## APPLIANCE PULLS (2 Sizes)

- A** 13-13/16in (351mm) LGTH  
12in (305mm) CTC - BP54023  
*ADA-Friendly item.*
- B** 19-15/16in (506mm) LGTH  
18in (457mm) CTC - BP54024  
*ADA-Friendly item.*

SKU-specific details & hardware included p. 109-111



Finishes shown above:  
1. G10 2. PN

*new!*

**Coordinating Hook** p. 103  
2-5/8in (67mm) LGTH  
BH36010

perfect style pairings



**LEVOIR**  
by Brizo

**AVENUE**  
by Hinkley Lighting



*new!*

**HIGHLAND RIDGE**

Amerock Bath Accessories  
Shown in Golden Champagne



## AVAILABLE FINISHES



**Polished Nickel**  
(PN)

**Satin Nickel**  
(G10)

**Weathered Nickel**  
(WN)

**Golden Champagne**  
(BBZ)

**Oil-Rubbed Bronze**  
(ORB)

**Black Bronze**  
(BBR)  
*Comparable to Matte Black*



- Pulls longer than 3in (76mm) CTC
- Appliance Pulls

Love the look:  
**Elegant, earthy glam.**

Kane in **Satin Nickel** on deep, slate cabinets



# Kane

## KNOBS (2 Sizes)



- A** 1-3/16in (30mm) DIA - BP53700
- B** 1-5/8in (41mm) DIA - BP53802

## PULLS (4 Sizes)



- A** 3-5/8in (92mm) LGTH  
3in (76mm) CTC - BP53701
- B** 4-7/16in (113mm) LGTH  
3-3/4in (96mm) CTC - BP53702  
*ADA-Friendly item.*
- C** 5-11/16in (144mm) LGTH  
5-1/16in (128mm) CTC - BP53802  
*ADA-Friendly item.*
- D** 7in (178mm) LGTH  
6-5/16in (160mm) CTC - BP53803  
*ADA-Friendly item.*

## CUP PULL



- A** 4-3/8in (111mm) LGTH  
3-3/4in (96mm) CTC - BP53801

## APPLIANCE PULLS (3 Sizes)



- A** 8-7/8in (225mm) LGTH  
8in (203mm) CTC - BP53804  
*ADA-Friendly item.*
- B** 12-15/16in (329mm) LGTH  
12in (305mm) CTC - BP53805  
*ADA-Friendly item.*
- C** 19-1/4in (489mm) LGTH  
18in (457mm) CTC - BP53806  
*ADA-Friendly item.*

SKU-specific details & hardware included p. 111-115



Finishes shown above:  
1. BBR 2. G10

perfect style pairings



**LOMBARDIA**  
by Rohl

**WINSLOW**  
by Kichler



**new!**  
**STATURE**

Amerock Bath Accessories  
Shown in Golden Champagne

**new!**  
**Coordinating Hook** p. 159  
2-1/4in (57mm) LGTH  
BH36090



## AVAILABLE FINISHES



**Polished Nickel**  
(PN)

**Satin Nickel**  
(G10)

**Antique Silver**  
(AS)

**Golden Champagne**  
(BBZ)

**Oil-Rubbed Bronze**  
(ORB)

**Gunmetal**  
(GM)

**Black Bronze**  
(BBR)  
*Comparable to Matte Black*



- Pulls longer than 3-3/4in (96mm) CTC
- Appliance Pulls

## STAY-PUT PLACEMENT

Small spikes on the base help ensure knobs won't rotate from the **desired orientation**.

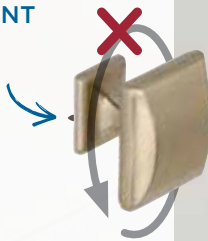

Love the look:  
**Airy neutrals with pops of gold.**

Candler in **Golden Champagne** on crisp white cabinets

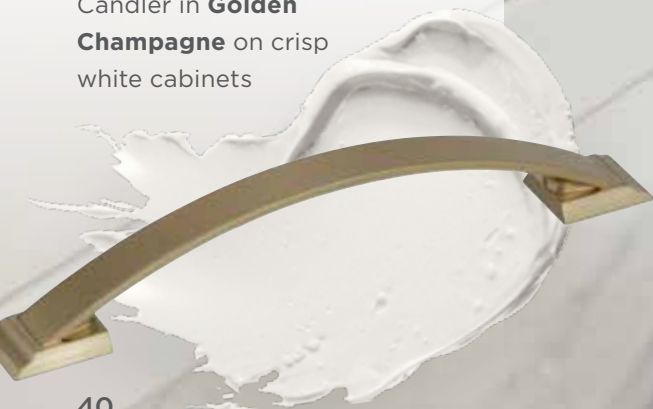



# Candler

## KNOBS (2 Sizes)



- A** 1-1/4in (32mm) LGTH - BP29340
- B** 1-1/2in (38mm) LGTH - BP29368

## PULLS (4 Sizes)



- A** 4-3/8in (111mm) LGTH  
3in (76mm) CTC - BP29349
- B** 5-3/16in (132mm) LGTH  
3-3/4in (96mm) CTC - BP29355
- C** 6-9/16in (167mm) LGTH  
5-1/16in (128mm) CTC - BP29363  
*ADA-Friendly item.*
- D** 7-15/16in (202mm) LGTH  
6-5/16in (160mm) CTC - BP29364  
*ADA-Friendly item.*

## APPLIANCE PULLS (3 Sizes)



- A** 10-1/4in (260mm) LGTH  
8in (203mm) CTC - BP29365\*  
*ADA-Friendly item.*
- B** 14-7/16in (367mm) LGTH  
12in (305mm) CTC - BP29366\*  
*ADA-Friendly item.*
- C** 20-3/4in (527mm) LGTH  
18in (457mm) CTC - BP29367\*  
*ADA-Friendly item.*

\* Not available in GM.

SKU-specific details & hardware included p. 115-118



Finishes shown above:  
1. G10 2. BBR

*perfect style pairing*



## CANDLER + ASHBY

**Better together:** Ashby cup pulls (p. 82) are a perfect companion.

## AVAILABLE FINISHES



**Satin Nickel**  
(G10)

**Graphite**  
(GPH)



- Pulls longer than 3in (76mm) CTC

Expert tips:  
**Reimagine the look with a variety of pull lengths.**

Follow this **general rule...**

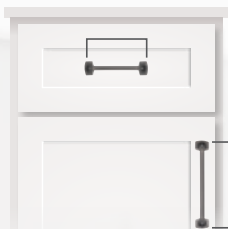

**1/2** or Less of  
Drawer Width

**1/3** or Less of  
Door Height

...or go *even longer*  
for a dramatic look.

Love the look:  
**Monochromatic drama.**

Rochdale in **Satin Nickel**  
on warm gray cabinets



# Rochdale

## KNOB



- A 1-1/4in (32mm) LGTH - BP53710

## PULLS (4 Sizes)

- A 4in (102mm) LGTH  
3in (76mm) CTC - BP53711
- B 4-3/4in (121mm) LGTH  
3-3/4in (96mm) CTC - BP53712  
*ADA-Friendly item.*
- C 6-1/16in (154mm) LGTH  
5-1/16in (128mm) CTC - BP53713  
*ADA-Friendly item.*
- D 7-5/16in (186mm) LGTH  
6-5/16in (160mm) CTC - BP53714  
*ADA-Friendly item.*

## CUP PULLS (2 Sizes)

- A 4-1/2in (114mm) LGTH  
3in (76mm) CTC - BP53715
- B 5-5/16in (135mm) LGTH  
3-3/4in (96mm) CTC - BP53716

SKU-specific details & hardware included p. 118 & 119



Finishes shown above:  
1. GPH 2. GIO

## A PERFECT COMPANION FOR GRAPHITE

Matte black finishes beautifully complement Amerock's Graphite.



**WINNIE**  
by Hinkley Lighting

**ALIGN**  
by Moen

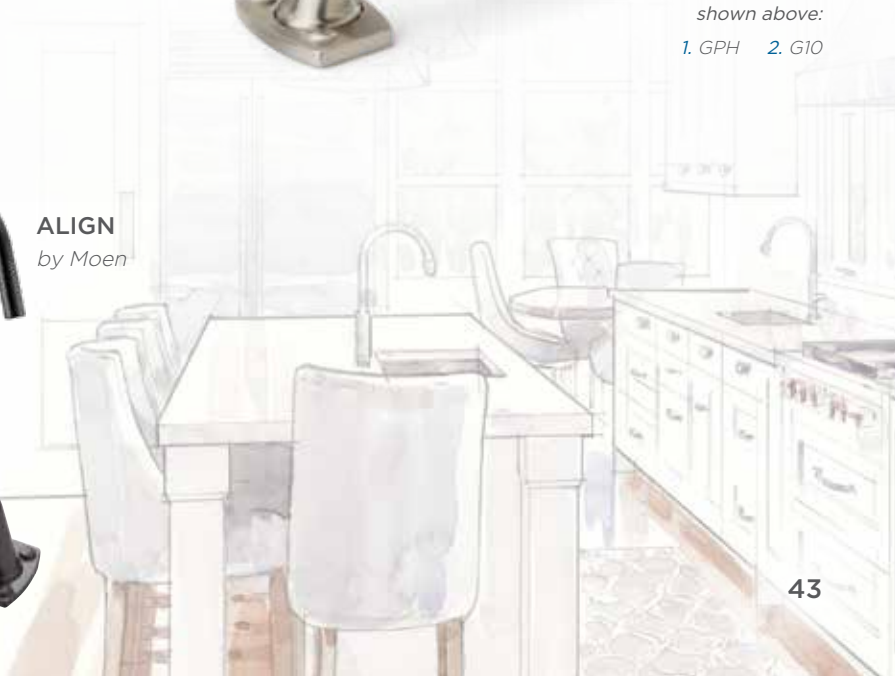



# contemporary

Glacio	46
Carrione	48
St. Vincent	50
London	52
Esquire	54
<i>new!</i> Bronx	56
Oberon	58
<i>new!</i> Concentric	60
<i>new!</i> Calathea	62
<i>new!</i> Kamari	64
<i>new!</i> Urbanite	66
<i>new!</i> Transcendent	68
Bar Pulls	70
Bar Pulls (Hollow)	72
Cyprus	74



1. Glacio
2. Bar Pulls
3. Kamari
4. Bronx
5. St. Vincent
6. Carrione

## AVAILABLE FINISHES

### Body/Posts

Clear/

**New!**

**Polished Chrome**  
(C26)

**Polished Nickel**  
(CPN)

**Satin Nickel**  
(CG10)

**Golden Champagne**  
(CBBZ)

**New!**

**Champagne Bronze**  
(CCZ)

**Oil-Rubbed Bronze**  
(CORB)

**Gunmetal**  
(CGM)

**Black Bronze**  
(CBBR)  
*Comparable to Matte Black*



Love the look:  
**Inviting contrast.**

Glacio in **Golden Champagne**  
or **Black Bronze** against  
bright neutrals

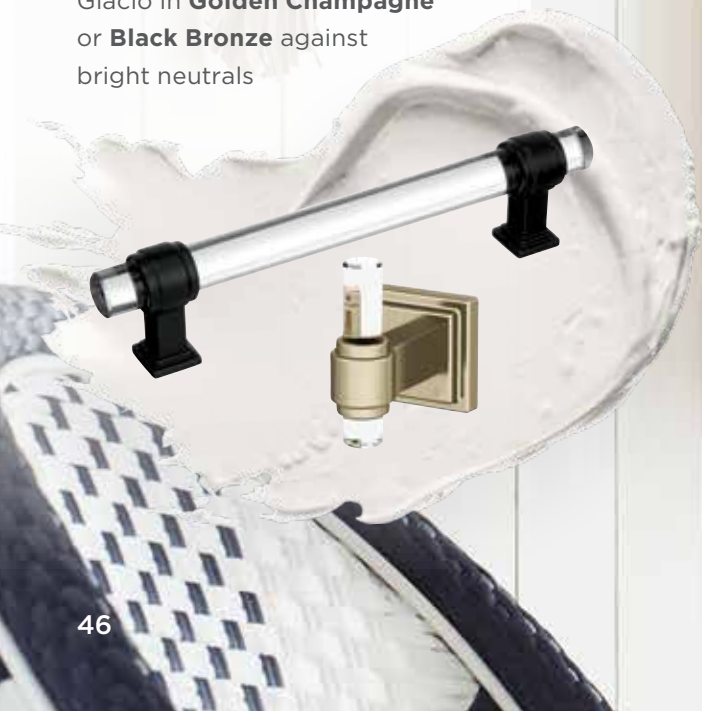

# Glacio

## KNOBS

-  **A** 1-3/4in (44mm) LGTH - BP36651  
Oval Knob
-  **B** 1-3/4in (44mm) DIA - BP36652  
Round Knob
-  **C** 1-3/8in (35mm) LGTH - BP36653  
Square Knob

## PULLS (4 Sizes)

-  **A** 4-9/16in (116mm) LGTH **New!**  
3in (76mm) CTC - BP36659
- B** 5-5/16in (135mm) LGTH  
3-3/4in (96mm) CTC - BP36654
- C** 6-9/16in (167mm) LGTH  
5-1/16in (128mm) CTC - BP36655
- D** 7-7/8in (200mm) LGTH  
6-5/16in (160mm) CTC - BP36656

SKU-specific details & hardware included p. 119-121

## How to install Glacio knobs.

To ensure the knob **lies flush** with the cabinet, the **stem** on the back of the knob must be **counterbored**.

See [Amerock.com](http://Amerock.com) for details.

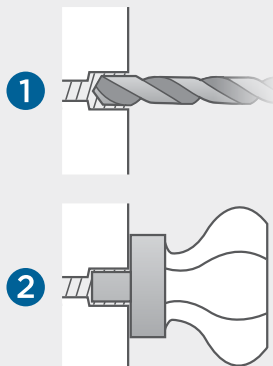

Finishes shown above:  
1. CPN 2. CBBZ

perfect style pairings



**KAMDEN**  
by Tech Lighting

**PURIST**  
by Kohler

*new!*  
**GLACIO**

Amerock Bath Accessories  
Shown in Clear/  
Golden Champagne

*new!*  
**Coordinating Hook** p. 119  
2-15/16in (75mm) LGTH  
BH36060



## AVAILABLE FINISHES

### Body/Posts

**Marble White/**

**Polished Nickel**  
(MWPN)

**Satin Nickel**  
(MWG10)

**Golden Champagne**  
(MWBBZ)

**Oil-Rubbed Bronze**  
(MWORB)

**Black Bronze**  
(MWBBR)  
*Comparable to Matte Black*

**Marble Black/**

**Polished Nickel**  
(MBKPN)

**Satin Nickel**  
(MBKG10)

**Golden Champagne**  
(MBKBBZ)

**Black Bronze**  
(MBKBBR)  
*Comparable to Matte Black*

Love the look:

### An unexpected retreat.

Carrione's **Marble White** and **Golden Champagne** accents against dramatic navy

This Old House  
**TOP 20**

BEST NEW HOME PRODUCTS

BATH

## House Beautiful

*Carrione recognized for its artistic flair in mixed materials.*





# Carrione

## KNOB



- A 2-1/2in (64mm) LGTH - BP36647

## PULLS (3 Sizes)

- A 6-5/16in (160mm) LGTH  
3-3/4in (96mm) CTC - BP36648
- B 7-1/2in (191mm) LGTH  
5-1/16in (128mm) CTC - BP36649
- C 8-3/4in (222mm) LGTH  
6-5/16in (160mm) CTC - BP36650

SKU-specific details & hardware included p. 121-123

## STAY-PUT PLACEMENT

Small spikes on the base help ensure knobs won't rotate from the **desired orientation**.



Finishes shown above:

- 1. MBKBBZ
- 2. MBKPN
- 3. MBKBBR
- 4. MBKG10
- 5. MWPN
- 6. MWBBZ
- 7. MWORB

perfect style pairings



## A PERFECT COMPANION FOR ADJACENT SPACES

### Try London in:

- Home office
- Butler's pantry
- Wet bar



LONDON  
p. 52



LOMBARDIA  
by Rohl

MILAN  
by Sean Lavin



new!

ST. VINCENT

Amerock Bath Accessories  
Shown in Chrome



new!  
Coordinating Hook p. 123  
3-7/16in (87mm) LGTH  
BH36040

## AVAILABLE FINISHES

**New!**

**Polished Chrome**  
(26)

**Polished Nickel**  
(PN)

**Satin Nickel**  
(G10)

**Golden Champagne**  
(BBZ)

**New!**

**Champagne Bronze**  
(CZ)

**Oil-Rubbed Bronze**  
(ORB)

**Black Bronze**  
(BBR)  
*Comparable to Matte Black*

### STAY-PUT PLACEMENT

Small spikes on the base help ensure knobs won't rotate from the **desired orientation**.

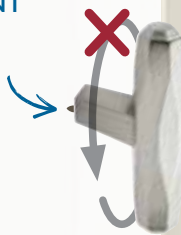

Love the look:  
**High-style sparkle.**

St. Vincent in **Champagne Bronze**, glittering against crisp neutrals



# St. Vincent

## KNOB



- A 2-1/2in (64mm) LGTH - BP36642

## PULLS (4 Sizes)



- A 5-7/16in (138mm) LGTH **New!**  
3in (76mm) CTC - BP36646
- B 6-5/16in (160mm) LGTH  
3-3/4in (96mm) CTC - BP36643
- C 7-1/2in (191mm) LGTH  
5-1/16in (128mm) CTC - BP36644
- D 8-3/4in (222mm) LGTH  
6-5/16in (160mm) CTC - BP36645

SKU-specific details & hardware included p. 123 & 124



Finishes shown above:

- 1. GIO 3. BBZ
- 2. PN 4. ORB

## STATEMENT ISLAND

For an **unexpected** statement with St. Vincent, try **Carrione** on an accent island.



**CARRIONE**  
p. 48

perfect style pairings



**DOUX**  
by Moen



**GINO**  
by Currey & Company

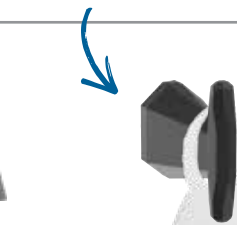

**new!**  
**ST. VINCENT**

Amerock Bath Accessories  
Shown in Matte Black

**new!**  
**Coordinating Hook** p. 123  
3-7/16in (87mm) LGTH  
BH36040

## AVAILABLE FINISHES

### Body/Posts

Polished Nickel/

**Black Chrome**  
(PNBCR)

**Black Bronze**  
(PNBBR)  
*Comparable to Matte Black*

Satin Nickel/

**Polished Chrome**  
(G1026)

**Black Chrome**  
(G10BCR)

Golden Champagne/

**Polished Chrome**  
(BBZ26)

**Black Chrome**  
(BBZBCR)

Black Chrome/

**Polished Chrome**  
(BCR26)

**Satin Nickel**  
(BCRG10)

**Golden Champagne**  
(BCRBBZ)

**Black Bronze/**  
*Comparable to Matte Black*

**Polished Chrome**  
(BBR26)

**Satin Nickel**  
(BBRG10)

**Golden Champagne**  
(BBRBBZ)

SILVER TONES

GOLD TONES

DARK TONES

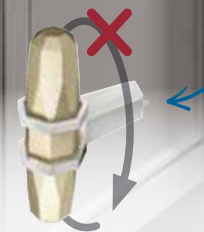
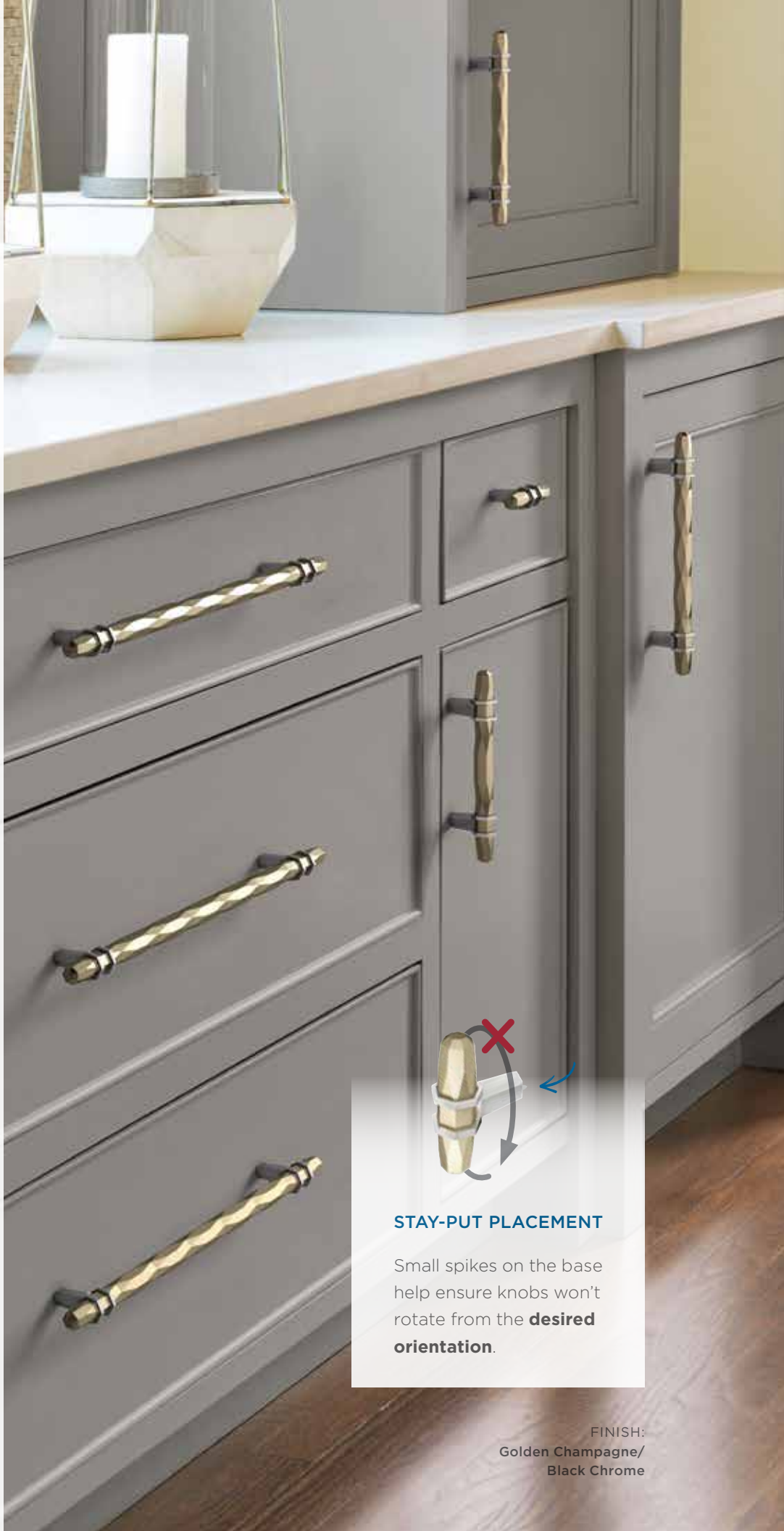

### STAY-PUT PLACEMENT

Small spikes on the base help ensure knobs won't rotate from the **desired orientation**.

FINISH:  
Golden Champagne/  
Black Chrome

# London

## KNOB



- A** 2-1/2in (64mm) LGTH - BP36647

## PULLS (5 Sizes)



- A** 6-5/16in (160mm) LGTH  
3-3/4in (96mm) CTC - BP36648
- B** 7-1/2in (191mm) LGTH  
5-1/16in (128mm) CTC - BP36649
- C** 8-3/4in (222mm) LGTH  
6-5/16in (160mm) CTC - BP36650
- D** 10-7/16in (265mm) LGTH  
8in (203mm) CTC - BP36663
- E** 12-1/2in (318mm) LGTH  
10-1/16in (256mm) CTC - BP36664

SKU-specific details & hardware included p. 124-127



Finishes shown above:  
1. BBR26  
2. BBZBCR



## A PERFECT PAIRING FOR ADJACENT SPACES

### Try Carrione in:

- Bath off the kitchen
- Butler's pantry
- Wet bar



**CARRIONE**  
p. 48

perfect style pairings



**TRINSIC**  
by Kichler



**ODIN**  
by Brizo



*new!*  
**Coordinating Hook** p. 123  
3-7/16in (87mm) LGTH  
BH36040

*new!*  
**ST. VINCENT**

Amerock Bath Accessories  
Shown in Chrome



## AVAILABLE FINISHES

### Posts/Body

Polished Nickel/

Stainless Steel  
(PNSS)

Golden Champagne  
(PNBBZ)

Gunmetal  
(PNGM)

Black Bronze  
(PNBBR)  
*Comparable to Matte Black*

Satin Nickel/

Oil-Rubbed Bronze  
(G10ORB)

## STAY-PUT PLACEMENT

Small spikes on the base help ensure knobs won't rotate from the **desired orientation**.



## Love the look: Luxury that glitters.

Esquire's **Black Bronze** and **Polished Nickel** accents on smoky wood cabinets



# Esquire

## KNOB



- A** 2-5/8in (67mm) LGTH - BP36556

## PULLS (6 Sizes)



- A** 4-11/16in (119mm) LGTH  
3in (76mm) or 3-3/4in (96mm) CTC - BP36557
- B** 5-15/16in (151mm) LGTH  
5-1/16in (128mm) CTC - BP36558
- C** 7-3/16in (183mm) LGTH  
6-5/16in (160mm) CTC - BP36559
- D** 8-7/8in (225mm) LGTH  
8in (203mm) CTC - BP36562
- E** 11in (279mm) LGTH  
10-1/16in (256mm) CTC - BP36560
- F** 13-1/2in (343mm) LGTH  
12-5/8in (320mm) CTC - BP36561

## DOUBLE HOOK

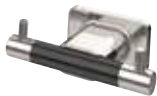

- A** 4-1/2in (114mm) LGTH - BA26613

SKU-specific details & hardware included p. 127-129

## TWO INSTALLATION OPTIONS

The **versatility** to upgrade to longer pulls using existing drill holes.

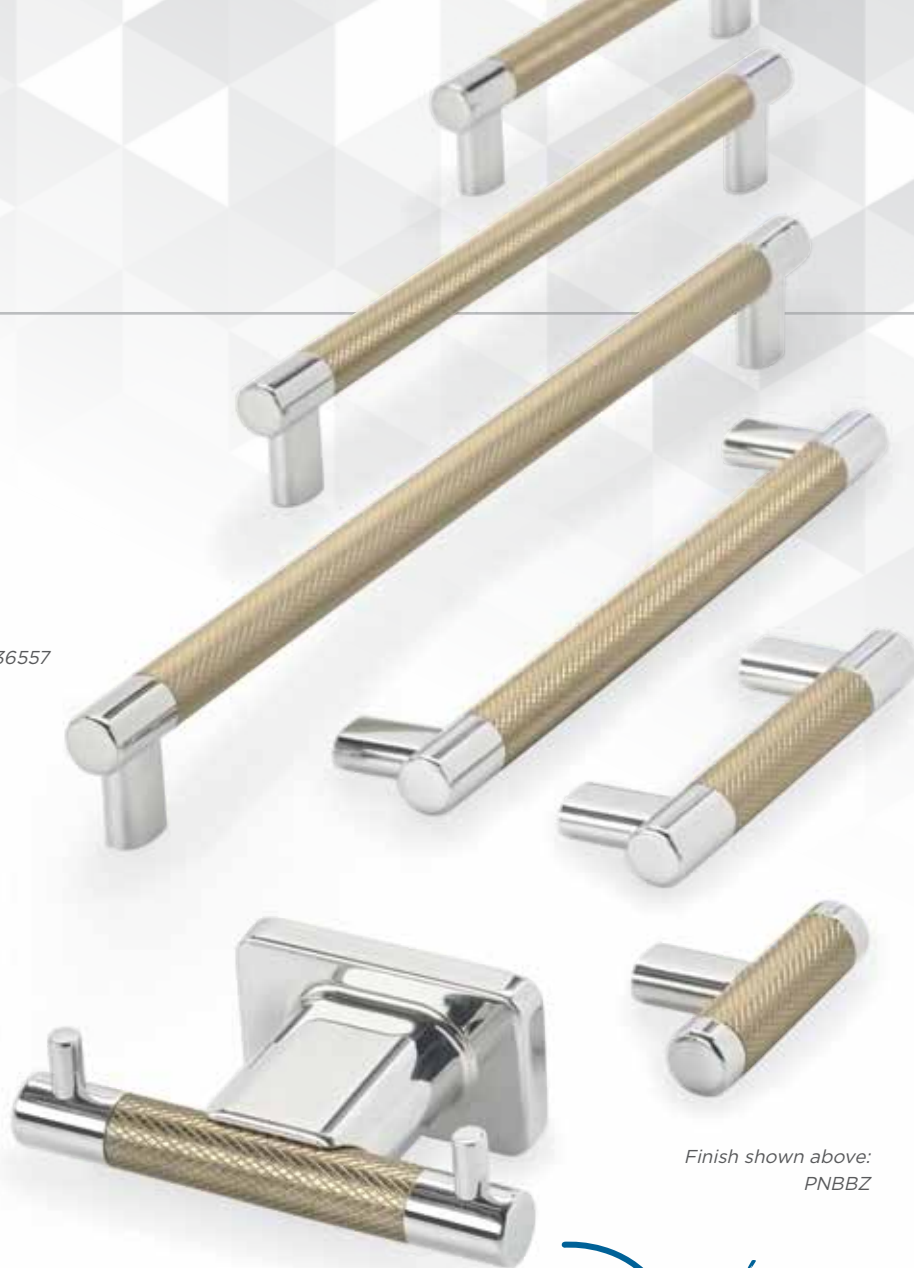

Finish shown above:  
PNBBZ

*new!*

**Single Hook** p. 127

2-11/16in (68mm) LGTH  
BH36563

perfect style pairings



**LITZE**  
by Brizo

**BRUNEAU**  
by Currey &  
Company



*new!*

**ESQUIRE**

Amerock Bath Accessories  
Shown in Polished Nickel/  
Golden Champagne



## AVAILABLE FINISHES



**Polished Nickel**  
(PN)

**Satin Nickel**  
(G10)

**Golden Champagne**  
(BBZ)

**Oil-Rubbed Bronze**  
(ORB)

**Gunmetal**  
(GM)

**Black Bronze**  
(BBR)  
*Comparable to Matte Black*

### STAY-PUT PLACEMENT

Small spikes on the base help ensure knobs won't rotate from the **desired orientation**.

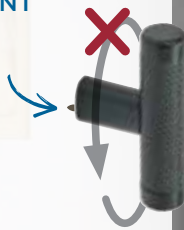

Love the look:  
**A warm retreat.**

Bronx in **Golden Champagne** against crisp, clean whites.



Unexpected  
companion:  
**ESQUIRE**  
*p. 54*



*new!*  
Bronx

**KNOB**



- A** 2-5/8in (67mm) LGTH - BP36556

**PULLS (6 Sizes)**



- A** 4-11/16in (119mm) LGTH  
3in (76mm) or 3-3/4in (96mm) CTC - BP36557
- B** 5-15/16in (151mm) LGTH  
5-1/16in (128mm) CTC - BP36558
- C** 7-3/16in (183mm) LGTH  
6-5/16in (160mm) CTC - BP36559
- D** 8-7/8in (225mm) LGTH  
8in (203mm) CTC - BP36562
- E** 11in (279mm) LGTH  
10-1/16in (256mm) CTC - BP36560
- F** 13-1/2in (343mm) LGTH  
12-5/8in (320mm) CTC - BP36561

**HOOK**



- A** 2-11/16in (68mm) LGTH - BH36563

**A VERSATILE BOON**

**Create order in the bath and beyond**, from entryway to home office, playroom or closet.

*SKU-specific details & hardware included p. 129-131*



*Finishes shown above:  
1. BBZ 2. PN*

*new!*  
**Coordinating Hook** p. 127  
2-11/16in (68mm) LGTH  
BH36563

*perfect style pairings*

**CLARION**  
by Progress Lighting



**LEVOIR**  
by Brizo

*new!*  
**ESQUIRE**

Amerock Bath Accessories  
Shown in Polished Nickel/Gunmetal



## AVAILABLE FINISHES



**Polished Nickel**  
(PN)

**Satin Nickel**  
(G10)

**Golden Champagne**  
(BBZ)

**Gunmetal**  
(GM)

**Matte Black**  
(MB)



**Frosted/**

**Polished Nickel**  
(PNFA)

**Satin Nickel**  
(G10FA)

**Golden Champagne**  
(BBZFA)

**Gunmetal**  
(GMFA)

**Matte Black**  
(MBFA)

Love the look:  
**Understated,  
organic appeal.**

Oberon's **Matte Black**  
and **Frosted** accents  
on gray-washed wood



# Oberon

## SOLID KNOBS (2 Sizes)



**A** 1-3/8in (35mm) DIA - BP36603

**B** 1-3/4in (44mm) DIA - BP36604  
Matte Black not available.

## FROSTED KNOBS (2 Sizes)



**A** 1-3/8in (35mm) DIA - BP36608

**B** 1-3/4in (44mm) DIA - BP36609  
Matte Black not available.

SKU-specific details & hardware included p. 131 & 132



*a versatile style:  
possibilities wide open*

Solid & frosted finish options shown above:

- 1. BBZ & BBZFA
- 2. PN & PNFA
- 3. GM & GMFA
- 4. G10 & G10FA
- 5. MB & MBFA



**CYPRUS**  
p. 74

**DAVENPORT**  
p. 30



**BAR PULLS**  
p. 70



## AVAILABLE FINISHES



**Polished Nickel**  
(PN)

**Satin Nickel**  
(G10)

**Golden Champagne**  
(BBZ)

**Gunmetal**  
(GM)

**Matte Black**  
(MB)

## STAY-PUT PLACEMENT

Small spikes on the base help ensure knobs won't rotate from the **desired orientation**.

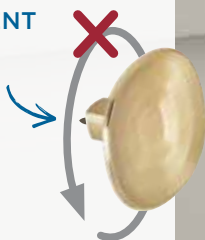

## Love the look: Glittering accents.

Concentric in **Polished Nickel**  
or **Golden Champagne** on  
dramatic neutrals



*new!*  
Concentric

**KNOB**



- A** 1-9/16in (40mm) DIA - BP36810

**FINGER PULL**



- A** 1-11/16in (43mm) LGTH  
1-1/4in (32mm) CTC - BP36811

**PULLS (2 Styles, 5 Sizes Each)**



- A** 4-3/16in (106mm) LGTH  
3-3/4in (96mm) CTC - BP36812
- B** 5-7/16in (138mm) LGTH  
5-1/16in (128mm) CTC - BP36813
- C** 6-11/16in (170mm) LGTH  
6-5/16in (160mm) CTC - BP36814
- D** 7-15/16in (202mm) LGTH  
7-9/16in (192mm) CTC - BP36815
- E** 10-7/16in (265mm) LGTH  
10-1/16in (256mm) CTC - BP36816



- A** 4-1/2in (114mm) LGTH  
3-3/4in (96mm) CTC - BP36830
- B** 5-3/4in (146mm) LGTH  
5-1/16in (128mm) CTC - BP36831
- C** 7in (178mm) LGTH  
6-5/16in (160mm) CTC - BP36832
- D** 8-1/4in (210mm) LGTH  
7-9/16in (192mm) CTC - BP36833
- E** 10-3/4in (273mm) LGTH  
10-1/16in (256mm) CTC - BP36834

SKU-specific details & hardware included p. 132-134



Finishes shown above:  
1. MB 2. PN

*new!*

**Coordinating Hook** p. 158  
2-1/4in (57mm) LGTH  
BH26542

*perfect style pairings*



**DOUX**  
by Moen

**AVENUE**  
by Hinkley Lighting



*new!*  
**ARRONDI**

Amerock Bath Accessories  
Shown in Matte Black



## AVAILABLE FINISHES



**Polished Chrome**  
(26)

**Satin Nickel**  
(G10)

**New!**  
**Brushed Gold**  
(BGL)

**Black Chrome**  
(BCR)

**Matte Black**  
(MB)



- Pulls longer than 1-1/4in (32mm) CTC

Love the look:  
**A sparkling retreat.**

Calathea in **Polished Chrome** on navy cabinets



*new!*  
Calathea

**PULLS (4 Sizes)**

- A** 1-15/16in (49mm) LGTH  
1-1/4in (32mm) CTC - BP10132
- B** 4-7/16in (113mm) LGTH  
3-3/4in (96mm) CTC - BP100396  
*ADA-Friendly item.*
- C** 5-11/16in (144mm) LGTH  
5-1/16in (128mm) CTC - BP1003128  
*ADA-Friendly item.*
- D** 7in (178mm) LGTH  
6-5/16in (160mm) CTC - BP1003160  
*ADA-Friendly item.*

SKU-specific details & hardware included p. 134 & 135

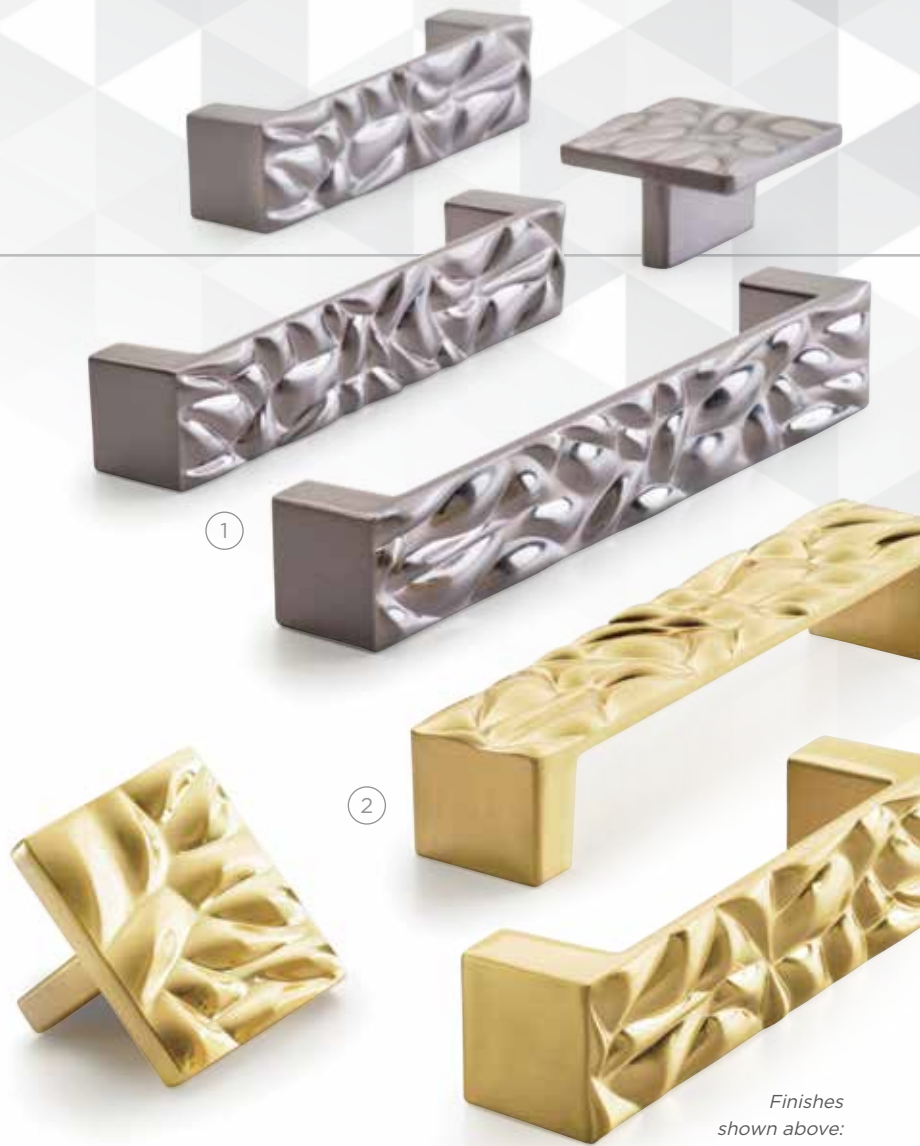

Finishes shown above:  
1. BCR 2. BGL



**THINK BEYOND THE KITCHEN & BATH**

**An unexpected statement in:**

- Master closet
- Home office
- Entryway



*perfect style pairings*

*new!*

**Coordinating Hook** p. 158

2-1/4in (57mm) LGTH

BH26542



*new!*

**ARRONDI**

Amerock Bath Accessories  
Shown in Matte Black

## AVAILABLE FINISHES



**Polished Nickel**  
(PN)

**Satin Nickel**  
(G10)

**Golden Champagne**  
(BBZ)

**Gunmetal**  
(GM)

**Matte Black**  
(MB)

Love the look:  
**Refreshingly playful.**

Kamari in **Golden Champagne** on grayed blue-green cabinets





# new! Kamari

## KNOBS



- A** 1-3/16in (30mm) DIA - BP36820
- B** 1-3/16in (30mm) LGTH - BP36821

## PULLS (5 Sizes)

- A** 4-15/16in (125mm) LGTH  
3-3/4in (96mm) CTC - BP36822
- B** 6-3/16in (157mm) LGTH  
5-1/16in (128mm) CTC - BP36823
- C** 7-7/16in (189mm) LGTH  
6-5/16in (160mm) CTC - BP36824
- D** 8-3/4in (222mm) LGTH  
7-9/16in (192mm) CTC - BP36825
- E** 11-1/4in (286mm) LGTH  
10-1/16in (256mm) CTC - BP36826

SKU-specific details & hardware included p. 135-137



Finishes shown above:  
1. MB 2. PN



### STAY-PUT PLACEMENT

Small spikes on the base help ensure knobs won't rotate from the **desired orientation**.

## perfect style pairings



**LITZE**  
by Brizo

**HARMON**  
by Currey & Company



**BLACKROCK**

Amerock Bath Accessories  
Shown in Champagne Bronze



**new!**  
**Coordinating Hook** p. 97  
3-9/16in (90mm) LGTH  
BH36000

## SOLID FINISH



**Matte Black**  
(MBMB)

## SPLIT FINISHES

### Posts/Body

**Polished Chrome/**

**Satin Nickel**  
(26G10)

**Black Chrome**  
(26BCR)

**New!**  
**Brushed Matte Black**  
(26BMB)

**White**  
(26WHT)



**New!**  
**Brushed Gold/**

**Black Chrome**  
(BGLBCR)

**Matte Black**  
(BGLMB)

**White**  
(BGLWHT)



Love the look:  
**Bright and serene.**

Urbanite's **Brushed Gold**  
and **White** accents on  
silvery gray cabinets



*new!*  
Urbanite

**KNOB**



- A** 2-5/8in (67mm) LGTH - BP67

**PULLS (5 Sizes)**



- A** 6-1/2in (165mm) LGTH  
3-3/4in (96mm) CTC - BP77896
- B** 7-13/16in (198mm) LGTH  
5-1/16in (128mm) CTC - BP778128
- C** 9-1/16in (230mm) LGTH  
6-5/16in (160mm) CTC - BP778160
- D** 10-1/4in (260mm) LGTH  
7-9/16in (192mm) CTC - BP778192
- E** 12-3/4in (324mm) LGTH  
10-1/16in (256mm) CTC - BP778256

SKU-specific details & hardware included p. 137-139

**A SOLID CHOICE**

A complementing **solid** Matte Black option is also available.

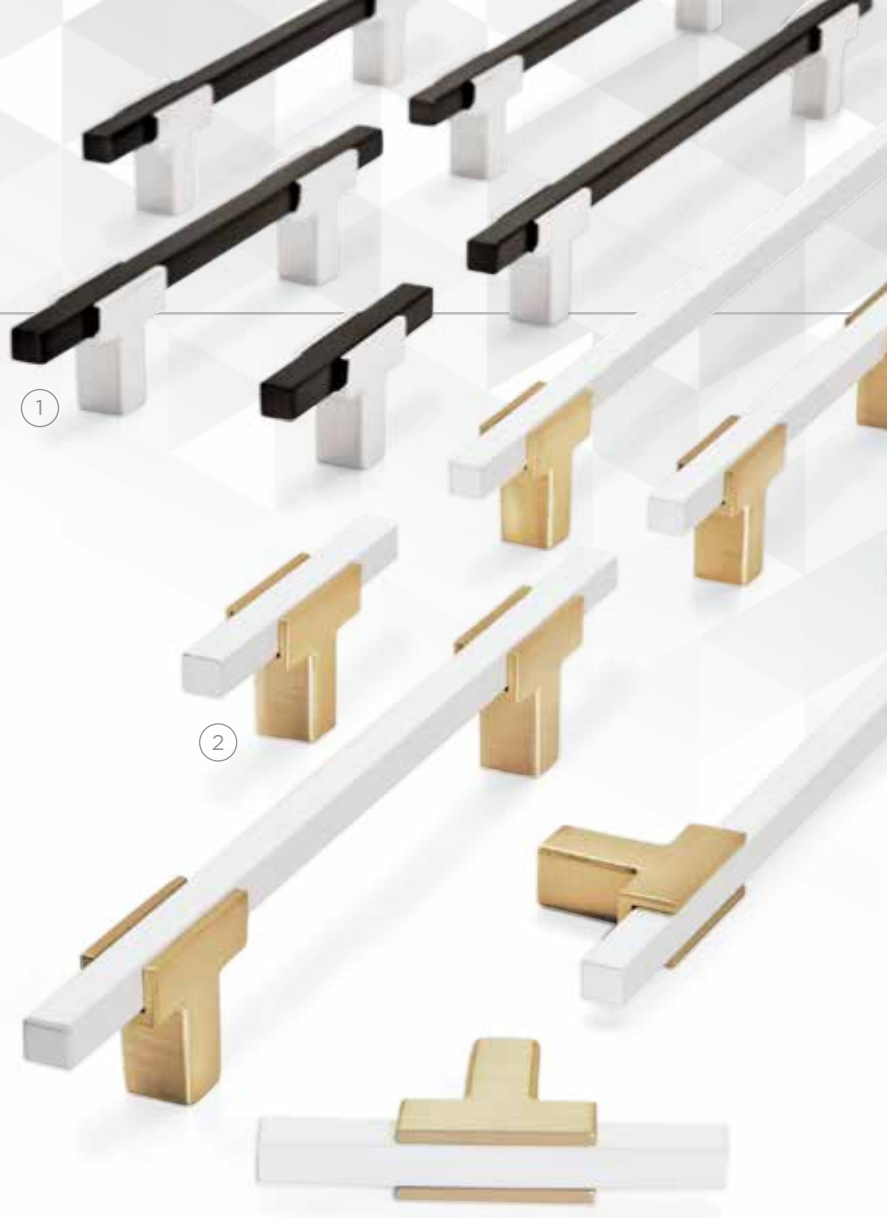

Finishes shown above:

- 1. 26BMB 2. BGLWHT

*new!*

**Coordinating Hook** p. 97  
3-9/16in (90mm) LGTH  
BH36000

*perfect style pairings*

**CLARION**  
by Progress Lighting



**ZURA**  
by Delta



*new!*  
**BLACKROCK**

Amerock Bath Accessories  
Shown in Matte Black



## SOLID FINISHES



**Polished Nickel**  
(PNPN)

**Silver Champagne**  
(SCSC)

**New!**  
**Matte Gold**  
(MGMG)

**Matte Black**  
(MBMB)

## SPLIT FINISHES



**Posts/Body**

**Matte Black/**

**Polished Nickel**  
(MBPN)

**Silver Champagne**  
(MBSC)

**New!**  
**Matte Gold**  
(MBMG)

Love the look:  
**Streamlined elegance.**

Transcendent in **Matte Black**  
and **Silver Champagne**  
on white cabinets



*new!*  
**Transcendent**

**KNOB**



- A** 1-1/4in (32mm) DIA - BP196732

**PULLS (7 Sizes)**



- A** 3-3/16in (81mm) LGTH  
 5/8in (16mm) CTC - BP741416
- B** 6-15/16in (176mm) LGTH  
 3-3/4in (96mm) CTC - BP741496
- C** 8-3/16in (208mm) LGTH  
 5-1/16in (128mm) CTC - BP7414128
- D** 9-7/16in (240mm) LGTH  
 6-5/16in (160mm) CTC - BP7414160
- E** 10-11/16in (271mm) LGTH  
 7-9/16in (192mm) CTC - BP7414192
- F** 13-3/16in (335mm) LGTH  
 10-1/16in (256mm) CTC - BP7414256
- G** 15-3/4in (400mm) LGTH  
 12-5/8in (320mm) CTC - BP7414320

*SKU-specific details & hardware included p. 139-141*



Finishes shown above:  
 1. MBMG 2. MGMG

**STATEMENT ISLAND**

For an **unexpected** statement, try using a split finish on an accent island.



*perfect style pairings*



**LOMBARDIA**  
 by Rohl

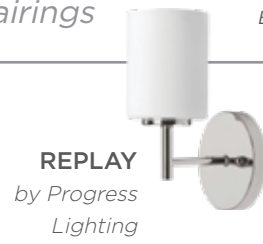

**REPLAY**  
 by Progress Lighting

*new!*  
**Coordinating Hook** p. 158  
 2-1/4in (57mm) LGTH  
 BH26542

*new!*  
**ARRONDI**

Amerock Bath Accessories  
 Shown in Polished Stainless Steel



## AVAILABLE FINISHES



**New!**

**Polished Chrome**  
(26)

**Polished Nickel**  
(PN)

**Sterling Nickel**  
(CSG9)

**Stainless Steel**  
(SS)

**Golden Champagne**  
(BBZ)

**New!**

**Champagne Bronze**  
(CZ)

**Oil-Rubbed Bronze**  
(ORB)

**Gunmetal**  
(GM)

**Black Bronze**  
(BBR)  
*Comparable to Matte Black*



**HOLLOW BAR  
PULLS AVAILABLE**

*p. 72*

Love the look:  
**Crisp & minimal.**

Bar Pulls and Glacio in  
**Black Bronze** on airy  
white cabinets



# Solid Bar Pulls

## KNOB

- A** 1-15/16 (49) LGTH - BP19009

## PULLS (11 Sizes)

- A** 5-3/8in (137mm) LGTH  
3in (76mm) CTC - BP40515  
BP19010 (Profile for CSG9 & SS)
- B** 6-1/8in (156mm) LGTH  
3-3/4in (96mm) CTC - BP40516  
BP19011 (Profile for CSG9 & SS)
- C** 7-3/8in (187mm) LGTH  
5-1/16in (128mm) CTC - BP40517  
BP19541 (Profile for CSG9 & SS)
- D** 9-15/16in (252mm) LGTH  
7-9/16in (192mm) CTC - BP40518  
BP19012 (Profile for CSG9 & SS)
- E** 13-1/4in (337mm) LGTH  
10-1/16in (256mm) CTC - BP40519  
BP19013 (Profile for CSG9 & SS)
- F** 15-3/4in (400mm) LGTH  
12-5/8in (320mm) CTC - BP19014
- G** 19-1/2in (495mm) LGTH  
16-3/8in (416mm) CTC - BP19015\*
- H** 22-1/16in (560mm) LGTH  
18-7/8in (480mm) CTC - BP19016
- I** 24-9/16in (624mm) LGTH  
21-7/16in (544mm) CTC - BP19017\*
- J** 28-5/16in (719mm) LGTH  
25-3/16in (640mm) CTC - BP19018\*
- K** 33-7/16in (849mm) LGTH  
30-1/4in (768mm) CTC - BP19019\*

## APPLIANCE PULLS (2 Sizes)

- A** 14-5/8in (371mm) LGTH  
12in (305mm) CTC - BP54008\*\*
- B** 20-5/8in (524mm) LGTH  
18in (457mm) CTC - BP54025\*\*\*

\* Only available in CSG9, SS & ORB.  
\*\* Not available in 26 or CZ.  
\*\*\* Not available in 26, CSG9, CZ or GM.



Finishes shown above:  
1. BBR 2. CZ

*new!*

**Coordinating Hook** p. 158  
2-1/4in (57mm) LGTH  
BH26542

*perfect style pairings*



**ELEVATE**  
by Progress  
Lighting

**ODIN**  
by Brizo

*new!*  
**ARRONDI**

Amerock Bath Accessories  
Shown in Champagne Bronze

SKU-specific details & hardware included p. 141-145

## AVAILABLE FINISH



**Stainless Steel**  
(SS)

## ADDITIONAL FINISHES

Available in **Solid Bar Pulls**.  
*p. 70*



Love the look:

**Crisp & minimal.**

Bar Pulls (Hollow) in  
**Stainless Steel** on earthy,  
greige cabinets.





# Hollow Bar Pulls

## PULLS (6 Sizes)

- A** 6-1/16in (154mm) LGTH  
3-3/4in (96mm) CTC - BP36800
- B** 6-7/8in (175mm) LGTH  
5-1/16in (128mm) CTC - BP36801
- C** 10-5/8in (270mm) LGTH  
7-9/16in (192mm) CTC - BP36802
- D** 11-7/8in (302mm) LGTH  
8-13/16in (224mm) CTC - BP36803
- E** 13-1/8in (333mm) LGTH  
10-1/16in (256mm) CTC - BP36804
- F** 14-7/16in (367mm) LGTH  
11-5/16in (288mm) CTC - BP36805

SKU-specific details & hardware  
included p. 146



Finish shown above:  
SS



### tips from the experts

Reimagine the look with  
a variety of pull lengths.

Follow this **general rule**...



...or go *even longer*  
for a dramatic look.

## AVAILABLE FINISHES



**Polished Nickel**  
(PN)

**Satin Nickel**  
(G10)

**Golden Champagne**  
(BBZ)

**Oil-Rubbed Bronze**  
(ORB)

**Black Bronze**  
(BBR)  
*Comparable to Matte Black*

Love the look:

**A warm invitation.**

Cyprus and Glacio in  
**Golden Champagne**  
glow against a stained  
accent island

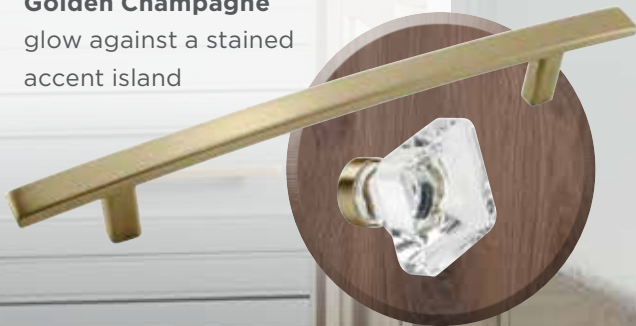

# Cyprus

## PULLS (4 Sizes)

- A** 5-1/4in (133mm) LGTH  
3in (76mm) CTC - BP26201
- B** 6-9/16in (167mm) LGTH  
3-3/4in (96mm) CTC - BP26203
- C** 7-13/16in (198mm) LGTH  
5-1/16in (128mm) CTC - BP9362
- D** 9-1/16in (230mm) LGTH  
6-5/16in (160mm) CTC - BP26204

## APPLIANCE PULLS (3 Sizes)

- A** 12in (305mm) LGTH  
8in (203mm) CTC - BP26205
- B** 16in (406mm) LGTH  
12in (305mm) CTC - BP26206
- C** 22in (559mm) LGTH  
18in (457mm) CTC - BP26207

SKU-specific details & hardware included p. 146-148

Finishes shown above:  
1. BBR 2. G10

*a versatile style:  
possibilities wide open*



**GLACIO**  
p. 46



**BLACKROCK**  
p. 28



**OBERON**  
p. 58





# traditional

---

Mulholland	<b>78</b>
Revitalize	<b>80</b>
Ashby	<b>82</b>
Grace Revitalize	<b>84</b>
Sea Grass	<b>86</b>



4

1. Revitalize
2. Ashby
3. Mulholland
4. Sea Grass

## AVAILABLE FINISHES



**New!**

**Polished Chrome**  
(26)

**Polished Nickel**  
(PN)

**Satin Nickel**  
(G10)

**Golden Champagne**  
(BBZ)

**New!**

**Champagne Bronze**  
(CZ)

**Gilded Bronze**  
(GB)

**Oil-Rubbed Bronze**  
(ORB)

**Gunmetal**  
(GM)

**Black Bronze**  
(BBR)  
*Comparable to Matte Black*

 **ADA**  
FRIENDLY

- Pulls longer than 3in (76mm) CTC
- Appliance Pulls

## STAY-PUT PLACEMENT

Small spikes on the base help ensure knobs won't rotate from the **desired orientation**.

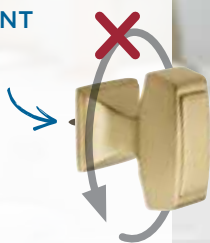

Love the look:  
**Comfortably classy.**

Mulholland in  
**Champagne Bronze**  
on milky white hues



# Mulholland

## KNOBS (2 Sizes)



- A** 1-1/4in (32mm) LGTH - BP53029
- B** 1-1/2in (38mm) LGTH - BP535342

## PULLS (4 Sizes)



- A** 3-3/4in (96mm) LGTH  
3in (76mm) CTC - BP53030
- B** 4-9/16in (116mm) LGTH  
3-3/4in (96mm) CTC - BP53031  
*ADA-Friendly item.*
- C** 5-7/8in (149mm) LGTH  
5-1/16in (128mm) CTC - BP53529  
*ADA-Friendly item.*
- D** 7-1/8in (181mm) LGTH  
6-5/16in (160mm) CTC - BP53530  
*ADA-Friendly item.*



## APPLIANCE PULLS (3 Sizes)

- A** 9-3/16in (233mm) LGTH  
8in (203mm) CTC - BP53531\*  
*ADA-Friendly item.*
- B** 13-3/16in (335mm) LGTH  
12in (305mm) CTC - BP53532\*  
*ADA-Friendly item.*
- C** 19-1/4in (489mm) LGTH  
18in (457mm) CTC - BP53533\*  
*ADA-Friendly item.*

\* Not available in 26, CZ or GM.

SKU-specific details & hardware included p. 148-152



Finishes shown above:  
1. BBZ 2. PN

perfect style pairings

*new!*

Coordinating Hook p. 148

4-1/4in (108mm) LGTH

BH36020

**KNOWSLEY**

by Currey & Company



**DOUX**  
by Moen



*new!*

**MULHOLLAND**

Amerock Bath Accessories  
Shown in Matte Black



## AVAILABLE FINISHES



**New!**

**Polished Chrome**  
(26)

**Polished Nickel**  
(PN)

**Satin Nickel**  
(G10)

**Golden Champagne**  
(BBZ)

**New!**

**Champagne Bronze**  
(CZ)

**Gilded Bronze**  
(GB)

**Oil-Rubbed Bronze**  
(ORB)

**Gunmetal**  
(GM)

**Black Bronze**  
(BBR)  
*Comparable to Matte Black*

### STAY-PUT PLACEMENT

Small spikes on the base help ensure knobs won't rotate from the **desired orientation**.

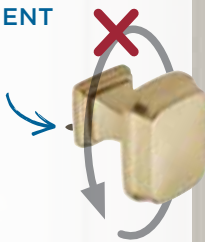

Love the look:

**A welcoming glow.**

Revitalize in **Champagne Bronze** on creamy, greige cabinets



 **ADA**  
FRIENDLY

- Pulls longer than 3in (76mm) CTC
- Appliance Pulls





# Revitalize

## KNOBS



- A** 1-1/4in (32mm) LGTH - BP55340
- B** 1-1/4in (32mm) DIA - BP55341\*
- C** 1-1/4in (32mm) DIA - BP55342

## PULLS (4 Sizes)

- A** 3-11/16in (94mm) LGTH  
3in (76mm) CTC - BP55343
- B** 4-5/16in (110mm) LGTH  
3-3/4in (96mm) CTC - BP55344  
*ADA-Friendly item.*
- C** 5-5/8in (143mm) LGTH  
5-1/16in (128mm) CTC - BP55346  
*ADA-Friendly item.*
- D** 6-13/16in (173mm) LGTH  
6-5/16in (160mm) CTC - BP55347  
*ADA-Friendly item.*

## APPLIANCE PULLS (3 Sizes)

- A** 8-13/16in (224mm) LGTH  
8in (203mm) CTC - BP55348\*\*  
*ADA-Friendly item.*
- B** 12-7/8in (327mm) LGTH  
12in (305mm) CTC - BP55349\*\*  
*ADA-Friendly item.*
- C** 18-7/8in (479mm) LGTH  
18in (457mm) CTC - BP55350\*\*  
*ADA-Friendly item.*

\* Only available in PN & ORB.

\*\* Not available in 26, CZ or GM.

SKU-specific details & hardware included p. 152-156



Finishes shown above:  
1. PN 2. CZ

perfect style pairings



**COLINET**  
by Moen

**BEL CANTO**  
by Currey & Company



*new!*  
**Coordinating Hook** p. 152  
2-1/8in (54mm) LGTH  
BH36030

*new!*  
**REVITALIZE**

Amerock Bath Accessories  
Shown in Matte Black



## AVAILABLE FINISHES



**Polished Nickel**  
(PN)

**Satin Nickel**  
(G10)

**Weathered Nickel**  
(WN)

**Golden Champagne**  
(BBZ)

**Oil-Rubbed Bronze**  
(ORB)

**Gunmetal**  
(GM)

*A versatile style:  
Possibilities wide open.*



**CANDLER**  
*p. 40*

**MULHOLLAND**  
*p. 78*



**GLACIO**  
*p. 46*

**KANE**  
*p. 38*



**BLACKROCK**  
*p. 28*



FINISH:  
Golden Champagne  
COLLECTIONS:  
Ashby & Candler

# Ashby

## CUP PULL

- A 5-1/16in (128mm) LGTH  
3in (76mm) or 4in (102mm) CTC - BP36640

SKU-specific details & hardware included p. 156

## HASSLE-FREE INSTALLATION

### Ashby

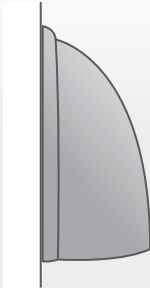

Stem-free design sits flush.

### Typical Cup Pull

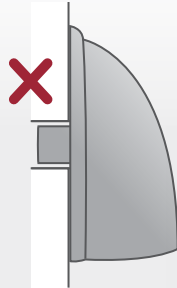

Stem requires counterbore drilling.

## TWO INSTALLATION OPTIONS

The **versatility** to **upgrade to cup pulls** using existing drill holes.

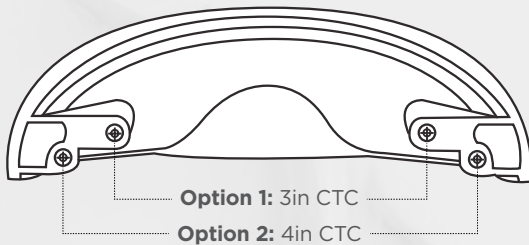

Finishes shown above:

- 1. WN
- 2. PN
- 3. ORB
- 4. BBZ
- 5. GM
- 6. G10

## INNOVATIVE COMFORT GRIP

**More than meets the eye,** designed with **ergonomics** in mind as more homeowners opt to age in place.



## AVAILABLE FINISHES



**Polished Nickel**  
(PN)

**Satin Nickel**  
(G10)

**Golden Champagne**  
(BBZ)

**Oil-Rubbed Bronze**  
(ORB)

**Black Bronze**  
(BBR)  
*Comparable to Matte Black*



Love the look:  
**A refreshing high note.**

Grace Revitalize  
in **Black Bronze**  
on powdery blue  
cabinets



# Grace Revitalize

## KNOBS (2 Sizes)



- A** 1-3/8in (35mm) LGTH - BP36628
- B** 1-3/4in (44mm) LGTH - BP36629

SKU-specific details & hardware included p. 157

### STAY-PUT PLACEMENT

Small spikes on the base help ensure knobs won't rotate from the **desired orientation**.

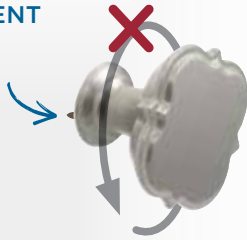

*new!*

Suggested Hook p. 152  
2-1/8in (54mm) LGTH  
BH36030



**CROSBY**  
by Kichler

*new!*  
**REVITALIZE**

Amerock Bath Accessories  
Shown in Matte Black

*perfect style pairings*



**REVITALIZE**  
Pulls  
p. 80



**PURIST**  
by Kohler

Finishes shown above:

- 1. ORB
- 2. PN
- 3. BBR
- 4. GIO
- 5. BBZ

## AVAILABLE FINISHES



**Satin Nickel**  
(G10)

**Golden Champagne**  
(BBZ)

**Oil-Rubbed Bronze**  
(ORB)

## STAY-PUT PLACEMENT

Small spikes on the base help ensure knobs won't rotate from the **desired orientation**.

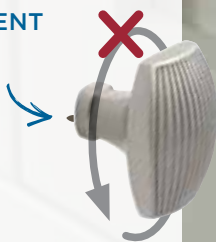

Love the look:  
**A twist on the average bar pull.**

Sea Grass in **Satin Nickel** on sage cabinets



# Sea Grass

## KNOBS (2 Sizes)



**A** 1-1/2in (38mm) LGTH - BP36614

**B** 1-3/4in (44mm) LGTH - BP36617

## PULLS (3 Sizes)



**A** 5in (127mm) LGTH  
3-3/4in (96mm) CTC - BP36621

**B** 6-1/4in (159mm) LGTH  
5-1/16in (128mm) CTC - BP36622

**C** 7-1/2in (191mm) LGTH  
6-5/16in (160mm) CTC - BP36623



## CUP PULL

**A** 3-7/8in (98mm) LGTH  
3in (76mm) CTC - BP36615

*SKU-specific details & hardware included p. 157 & 158*

*new!*

**Suggested Hook** p. 158

1-7/8in (48mm) LGTH  
BH36070



**WARWICK**  
by Currey & Company

*new!*

**APPOINT**

Amerock Bath Accessories  
Shown in Golden Champagne



**PURIST**  
by Kohler



**CRAWFORD**  
Knob  
by Amerock



①



②



Finishes shown above:  
1. BBZ 2. GIO

*perfect style pairings*





A *tailored* and *simplified* selling experience.

Choose one of three display options that **best fits your business model.**

1

## INTERACTIVE BOARDS

Customers can **easily remove hardware** from the boards and **visualize it directly** on their cabinet selection.



*Dimensions:* 21-1/2in W x 18in H

*Mounting hardware included for slat wall or sheetrock.*

*See p. 90 for ordering information.*

### Features for smooth selling:



#### Included product map

shows SKU-specific details, additional sizes and finishes.

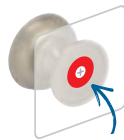

#### Color-coded samples

help keep the boards organized.



#### Included reset map

shows recommended product layout.

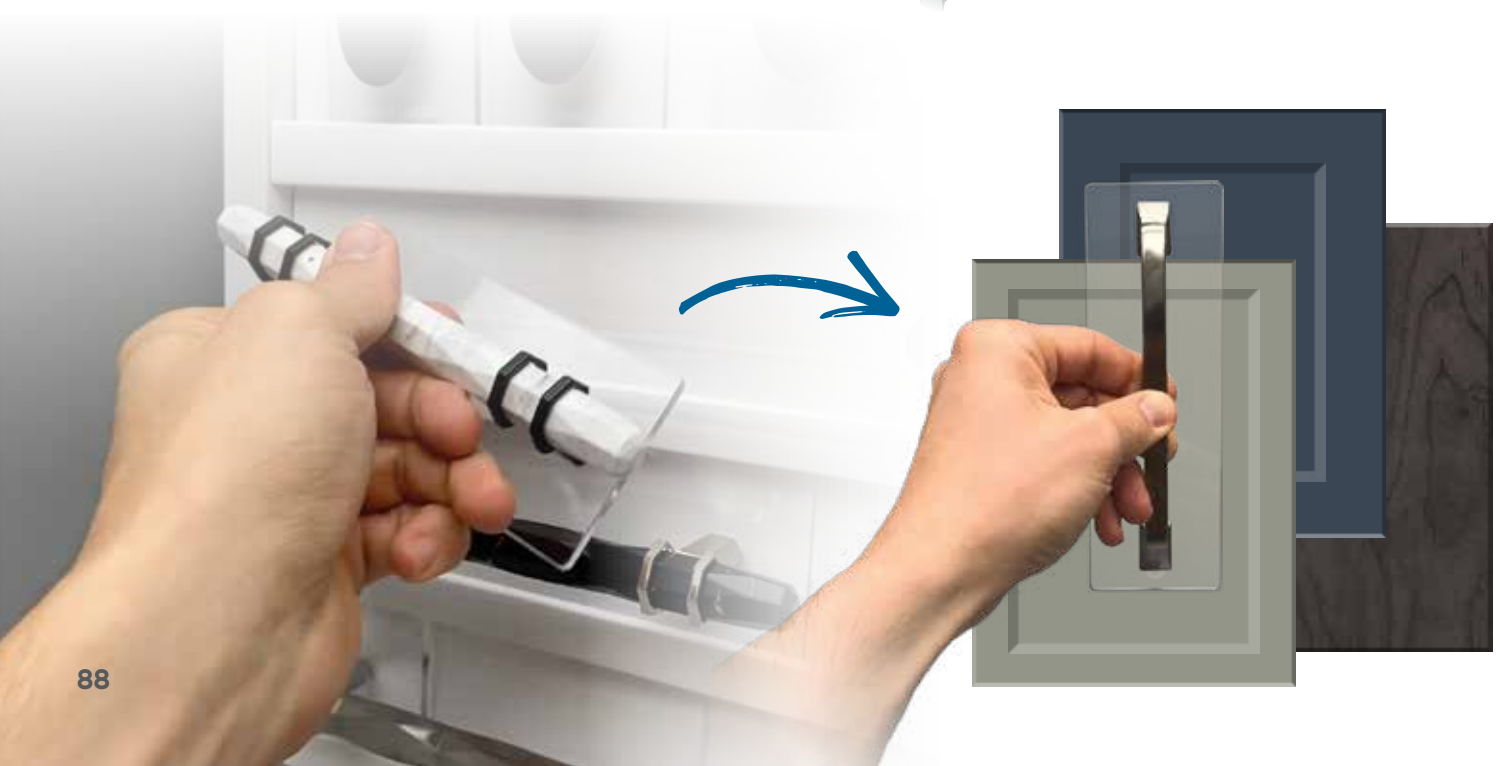





**Dimensions:** 24in W x 16in H

**Mounting hardware included for slat wall or sheetrock.**

See p. 90 for ordering information.

## STATIC BOARDS

Elegant **white gloss** display boards feature **fixed hardware** for those preferring a static option.

### Features for smooth selling:



**Included product map** shows SKU-specific details, additional sizes and finishes.



**Hardware can be unscrewed** to show alternate finishes or update the offering.



### Product Assortments

See p. 90 for ordering information.

### Tray (Sold separately)

Part No. CDB19046

**Dimensions:** 18in L x 14in W x 2-1/4in D

### Optional Lid (Sold separately)

Part No. CDB19047

## CURATED TRAYS

**Maximize the versatility** of your displays with a complementing tray, which can also fit into vignette drawers.

### Features for smooth selling:



**Included product map** shows SKU-specific details, additional sizes and finishes.



**Included reset map** shows recommended product layout.

## Different shades of **modern.**

A tray assortment showcasing our newest modern styles that offer a **nonconventional** take on **texture** and **split-finish** design.

Part No. CDB190080

*new!*

### Collections included:

- Calathea (p. 62)
- Concentric (p. 60)
- Kamari (p. 64)
- Transcendent (p. 68)
- Urbanite (p. 66)



Contact your Amerock sales rep to learn more about our merchandising options and special bundle pricing.

# Merchandising options to showcase the collections in this catalog.

## Board Dimensions

*Interactive:* 21-1/2in W x 18in H

*Static:* 24in W x 16in H

### Amerock MSRP-Grouped Boards



- Our most popular collections
- Three MSRP groups focusing on better and best price points

	1 <i>Interactive</i>	2 <i>Static</i>	3 <i>Tray Assortment</i>
<i>Board 2 (Better)</i>	CDB19028	CDB19021	CDB19043
<i>Board 3 (Better)</i>	CDB19029	CDB19022	CDB19044
<i>Board 4 (Best)</i>	CDB19030	CDB19023	CDB19045

### Amerock 2020 Couture Collections



- Split-finish collections
- New finish combinations

	1 <i>Interactive</i>	2 <i>Static</i>	3 <i>Tray Assortment</i>
<i>2020 Couture Collections</i>	CDB19062	CDB19061	CDB19063

### Appliance Pulls



- Complement the collections on our MSRP-grouped boards

	1 <i>Interactive</i>	2 <i>Static</i>	3 <i>Tray Assortment</i>
<i>Board 1 (Better/Best)</i>	—	CDB19082	—
<i>Board 2 (Best)</i>	—	CDB19083	—

— Not available

# Additional options to complete your offering.

### Allison by Amerock MSRP-Grouped Boards



- Three MSRP groups focusing on good and better price points

	1 <i>Interactive</i>	2 <i>Static</i>	3 <i>Tray Assortment</i>
<i>Board 1 (Good)</i>	CDB19074	CDB19071	CDB19077
<i>Board 2 (Better)</i>	CDB19075	CDB19072	CDB19078
<i>Board 3 (Better)</i>	CDB19076	CDB19073	CDB19079

### Amerock Euro Contemporary Collections



- Emerging finishes and extended pull lengths

	1 <i>Interactive</i>	2 <i>Static</i>	3 <i>Tray Assortment</i>
<i>Euro Contemporary Collections</i>	CDB19041	CDB19040	CDB19060

# Merchandising **your way.**

Three sleek, streamlined solutions with an elegant matte navy palette.



**A**

## FLOATING WALL DISPLAY

Part No. CDB19052

**Dimensions:**  
30in W x 64-1/2in H



**Looking to expand your display footprint?** Utilize multiple wall displays.

- Display **floats** off wall surface
- Holds **three** Interactive or Static boards, sold separately
- Includes **mounting hardware** for slat wall or sheetrock



**B**

## ROTATING 2-SIDED TOWER

Part No. CDB19053

**Dimensions:**  
31-1/2in W x 31-1/2in D x 82-3/4in H

- Holds **six** Interactive or Static boards, sold separately



**C**

## 2-SIDED RETAIL DISPLAY

Part No. CDB19090

**Dimensions:**  
32-1/4in W x 20in D x 74in H

- **Non-rotating**
- Holds **six** Interactive or Static boards, sold separately
- Includes 2 options: **locking caster wheels** or **leveling feet**



*coming soon...*

## Finish samples.

Showcases Amerock's **trending finishes** with a customizable **Cabinet Hardware Chip Ring.**

Part No. FCRNG004

## INCLUDED FINISH CHIPS

- |  |   |
|--|---|
|  Polished Chrome  |  Champagne Bronze  |
|  Polished Nickel  |  Oil-Rubbed Bronze |
|  Satin Nickel     |  Black Bronze      |
|  Stainless Steel  |  Matte Black       |
|  Golden Champagne |   |

# Amerock is the right choice for **designers** and **builders**.

Key software partnerships make it easier than ever to bring Amerock into your designs.



# 2020™

ACCREDITED MANUFACTURER

## Amerock streamlines the hardware selection process.

Now that Amerock's add-on catalog can be utilized **within a cabinet manufacturer's catalog**, this it's easier than ever for **thousands of dealers and designers** to bring Amerock into their **2020 Design Live** projects.

### How do I find and utilize Amerock products within 2020 Design Live?

First, you'll need to download and install Amerock's catalog (See video **1** on the right).

Second, add "**Amerock Hardware**" as an add-on to any selected cabinet in your design (from any cabinetry brand catalog) or apply the add-ons to all cabinets within the design through **Global Attributes** (See video **2** on the right).

Third, click on **Styles & Pricing** to select the desired Amerock hardware.

Find the following 'how-to' videos on the 2020 Design Live YouTube channel at

[youtube.com/2020DesignSoftware](https://youtube.com/2020DesignSoftware)



1

"Your Burning Questions, Answered"

View from 18:11 - 19:56



2

"2020 Design Tip: Adding Amerock Hardware to Your Designs"

## What version of 2020 Design Live do I need to access Amerock's products?

You can use Amerock's catalogs in **versions 11.9 and up**. For the best performance and render quality, 2020 Spaces recommends using the latest version.

## Can I add Amerock to spaces beyond the kitchen and bath?

Yes. With the **2020 Closet add-on** for 2020 Design Live, you can bring Amerock products into **alternative spaces** like home offices, master closets, laundry rooms and entryways.

Visit [2020spaces.com/training/2020design](http://2020spaces.com/training/2020design) for additional training or contact 2020 customer support at **1-866-697-2020**.

# envision™

## How do I find Amerock's products on Envision?

To find a curated selection of Amerock products available in **Envision** design software, click the *View Products* link in the *Global Navigation Bar*. You can then link products to your project by using the *Options Manager* (see below.)

## Can my clients and I visualize Amerock hardware in each project?

Yes, with the Envision Room Visualizer at your website or showroom, you can **show Amerock installed** in a **3-D room environment**.

To learn more about the software, contact *Envision customer support* at **1-866-651-8866** or [info@thebdx.com](mailto:info@thebdx.com).

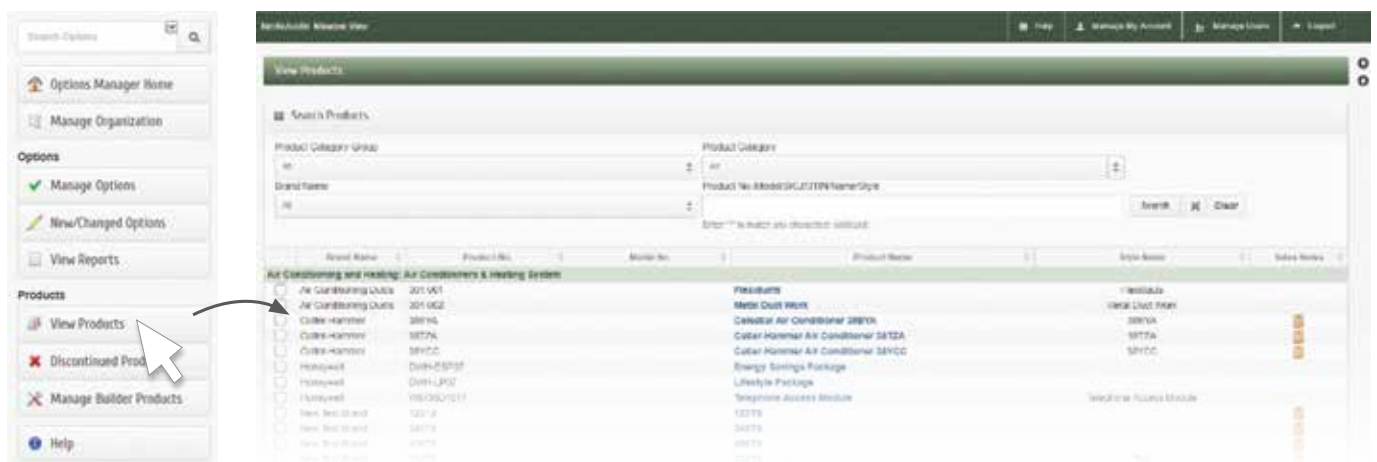



## REFERENCE DRAWINGS

Symbol	Description
L	Length
W	Width
P	Projection
C	Center-to-Center
BL	Base Length
BW	Base Width

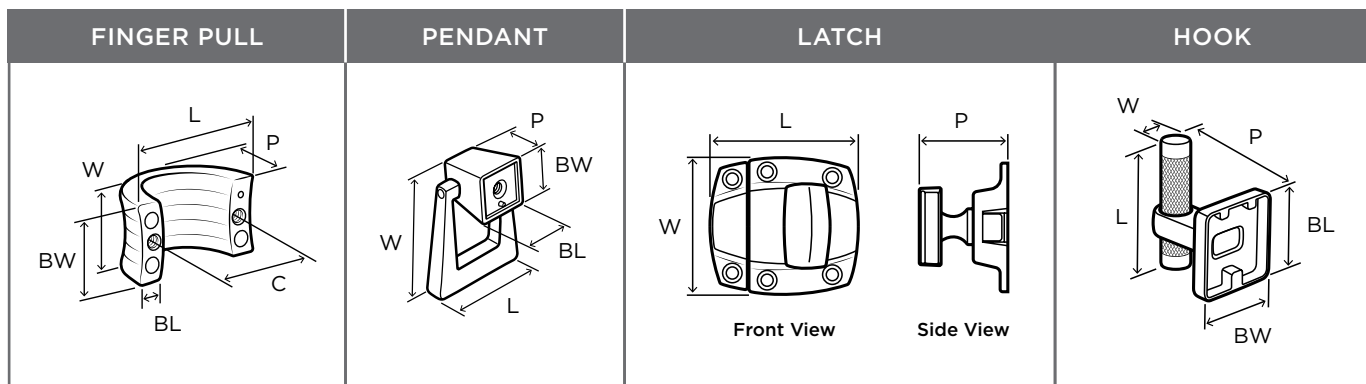
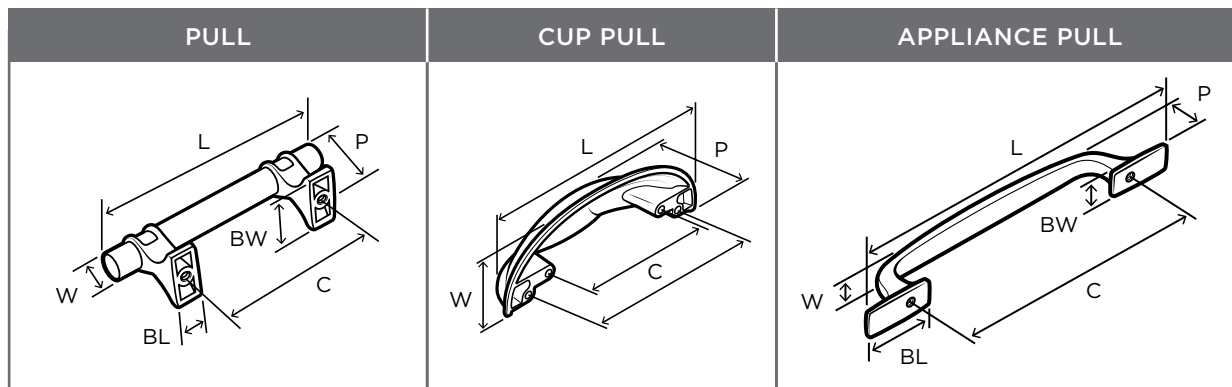
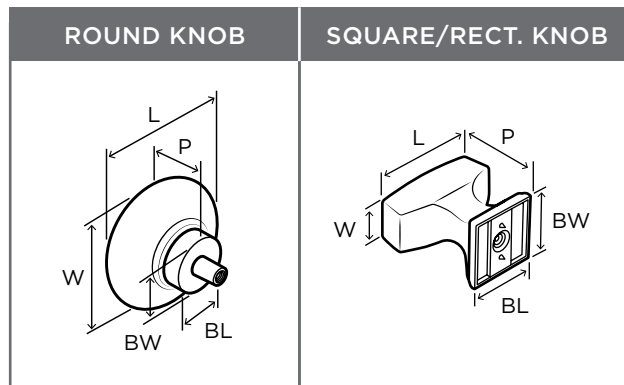

# BOX QUANTITIES

Profile	Shelf Pack QTY	Master Pack QTY
<b>Blackrock • p. 28</b>		
BP55270, BP55271, BP55275, BP55276	25	200
BP55272, BP55273, BP55274	10	120
BP55277, BP55278	10	80
BP55279, BP55280, BP55281	N/A	10
BH36000	12	N/A
<b>Davenport • p. 30</b>		
BP36600, BP36601	25	200
BP36602, BP36605	25	100
BP36606	10	80
BP36607	10	40
BH36050	8	N/A
<b>Highland Ridge • p. 32</b>		
BP55311, BP55312, BP55316	10	120
BP55315, BP55317, BP55318, BP55319, BP55321	10	80
BP55322, BP55323, BP55324	N/A	10
BH36010	12	N/A
<b>Overton • p. 34</b>		
BP36680	40	160
BP36681, BP36682	30	120
BP36683	25	100
BP36684, BP36685	20	80
<b>Westerly • p. 36</b>		
BP53717, BP53718	25	200
BP53719, BP53720, BP53721, BP53722	25	100
BP54023, BP54024	N/A	10
<b>Kane • p. 38</b>		
BP53700, BP53701, BP53702	25	200
BP53801	25	100
BP53802, BP53803, BP538072	10	80
BP53804, BP53805, BP53806	N/A	10
<b>Candler • p. 40</b>		
BP29340, BP29349, BP29368	10	120
BP29355, BP29363, BP29364	10	80
BP29365, BP29366, BP29367	N/A	10

Profile	Shelf Pack QTY	Master Pack QTY
<b>Rochdale • p. 42</b>		
BP53710	25	200
BP53711, BP53712, BP53713, BP53714, BP53715, BP53716	25	100
<b>Glacio • p. 46</b>		
BP36651, BP36652, BP36653	24	240
BP36654, BP36659	25	150
BP36655, BP36656	10	60
BH36060	8	N/A
<b>Carrione • p. 48</b>		
BP36647	30	240
BP36648, BP36649, BP36650	10	80
<b>St. Vincent • p. 50</b>		
BP36642	25	200
BP36643, BP36644, BP36645, BP36646	10	80
BH36040	8	N/A
<b>London • p. 52</b>		
BP36647	30	240
BP36648, BP36649, BP36650	10	80
BP36663	10	40
BP36664	10	20
<b>Esquire • p. 54</b>		
BP36556, BP36557	25	200
BP36558, BP36559, BP36562	10	80
BP36560, BP36561	10	60
BH36563	16	N/A
BA26613	8	N/A
<b>Bronx • p. 56</b>		
BP36556, BP36557	25	200
BP36558, BP36559, BP36562	10	80
BP36560, BP36561	10	60
BH36563	16	N/A
<b>Oberon • p. 58</b>		
BP36603, BP36608	25	200
BP36604, BP36609	10	80

# BOX QUANTITIES

Profile	Shelf Pack QTY	Master Pack QTY
<b>Concentric • p. 60</b>		
BP36830, BP36831, BP36832, BP36833	20	200
BP36834	15	150
BP36810, BP36811	20	100
BP36812, BP36813	10	100
BP36814, BP36815	10	60
BP36816	10	50
<b>Calathea • p. 62</b>		
BP10132	50	150
BP100396	40	120
BP1003128	32	96
BP1003160	25	75
<b>Kamari • p. 64</b>		
BP36820, BP36821	25	250
BP36822, BP36823, BP36824	20	100
BP36825	10	80
BP36826	10	60
<b>Urbanite • p. 66</b>		
BP67	75	300
BP77896, BP778128	40	160
BP778160, BP778192, BP778256	30	120
<b>Transcendent • p. 68</b>		
BP196732, BP741416	20	160
BP741496, BP7414128, BP7414160, BP7414192, BP7414256, BP7414320	20	120
<b>Bar Pulls (Solid) • p. 70</b>		
BP19009	10	120
BP19010, BP19011, BP19541, BP40515, BP40516, BP40517	10	100
BP19012, BP40518	10	60
BP19013, BP19014, BP40519	10	50
BP19015	10	40
BP19016, BP19017	10	30
BP19018, BP19019	5	20
BP54008, BP54025	N/A	10
<b>Bar Pulls (Hollow) • p. 72</b>		
BP36800, BP36801, BP36802, BP36803, BP36804	20	200
BP36805	10	100

Profile	Shelf Pack QTY	Master Pack QTY
<b>Cyprus • p. 74</b>		
BP26201	25	200
BP26203	25	100
BP26204	10	80
BP9362 (PN, ORB & BBR)	10	80
BP9362 (GIO & BBZ)	10	40
BP26205, BP26206, BP26207	N/A	10
<b>Mulholland • p. 78</b>		
BP53029, BP53030	25	200
BP535342	10	120
BP53031	25	100
BP53529, BP53530	10	80
BP53531, BP53532, BP53533	N/A	10
BH36020	12	N/A
<b>Revitalize • p. 80</b>		
BP55340, BP55341, BP55342, BP55343, BP55344	25	200
BP55346, BP55347	10	80
BP55348, BP55349, BP55350	N/A	10
BH36030	12	N/A
<b>Ashby • p. 82</b>		
BP36640	10	80
<b>Grace Revitalize • p. 84</b>		
BP36628	25	200
BP36629	10	120
<b>Sea Grass • p. 86</b>		
BP36614	25	200
BP36617	10	120
BP36615, BP36621, BP36622, BP36623	10	80
<b>Arrondi Hooks • p. 25</b>		
BH26542	8	N/A
<b>Appoint Hooks • p. 25</b>		
BH36070	60	N/A
<b>Monument Hooks • p. 25</b>		
BH36080	60	N/A
<b>Stature Hooks • p. 25</b>		
BH36090	60	N/A



# PRODUCT INDEX

Product No.	Type	Finish	Product Detail in (mm)	Length in (mm)	Width in (mm)	Projection in (mm)	Base Dimensions in (mm)	Base Material	Mounting Hardware Included	ADA-Friendly
<b>Blackrock • p. 28</b>										
BH3600026	Robe Hook	Chrome	Single	3-9/16 (90)	3/4 (19)	2-1/8 (52)	1-7/8 L x 1-3/4 W (48 L x 44 W)	Zinc	(2) #8 x 1-1/4 in. Sheet Metal Screw (1) Mounting Bracket	N/A
BH36000BZ	Robe Hook	Golden Champagne	Single	3-9/16 (90)	3/4 (19)	2-1/8 (52)	1-7/8 L x 1-3/4 W (48 L x 44 W)	Zinc	(2) #8 x 1-1/4 in. Sheet Metal Screw (1) Mounting Bracket	N/A
BH36000CZ	Robe Hook	Champagne Bronze	Single	3-9/16 (90)	3/4 (19)	2-1/8 (52)	1-7/8 L x 1-3/4 W (48 L x 44 W)	Zinc	(2) #8 x 1-1/4 in. Sheet Metal Screw (1) Mounting Bracket	N/A
BH36000G10	Robe Hook	Brushed Nickel	Single	3-9/16 (90)	3/4 (19)	2-1/8 (52)	1-7/8 L x 1-3/4 W (48 L x 44 W)	Zinc	(2) #8 x 1-1/4 in. Sheet Metal Screw (1) Mounting Bracket	N/A
BH36000MB	Robe Hook	Matte Black	Single	3-9/16 (90)	3/4 (19)	2-1/8 (52)	1-7/8 L x 1-3/4 W (48 L x 44 W)	Zinc	(2) #8 x 1-1/4 in. Sheet Metal Screw (1) Mounting Bracket	N/A
BH36000ORB	Robe Hook	Oil-Rubbed Bronze	Single	3-9/16 (90)	3/4 (19)	2-1/8 (52)	1-7/8 L x 1-3/4 W (48 L x 44 W)	Zinc	(2) #8 x 1-1/4 in. Sheet Metal Screw (1) Mounting Bracket	N/A
BP5527026	Knob	Polished Chrome	1-5/16 (33) DIA	1-5/16 (33)	N/A	1-1/16 (27)	5/8 L x 5/8 W (16 L x 16 W)	Zinc	(1) #8-32 x 1in Truss Head Machine Screw (1) #8-32 x 1-1/2in Truss Head Machine Screw	N/A
BP55270BBR	Knob	Black Bronze	1-5/16 (33) DIA	1-5/16 (33)	N/A	1-1/16 (27)	5/8 L x 5/8 W (16 L x 16 W)	Zinc	(1) #8-32 x 1in Truss Head Machine Screw (1) #8-32 x 1-1/2in Truss Head Machine Screw	N/A
BP55270BBZ	Knob	Golden Champagne	1-5/16 (33) DIA	1-5/16 (33)	N/A	1-1/16 (27)	5/8 L x 5/8 W (16 L x 16 W)	Zinc	(1) #8-32 x 1in Truss Head Machine Screw (1) #8-32 x 1-1/2in Truss Head Machine Screw	N/A
BP55270CZ	Knob	Champagne Bronze	1-5/16 (33) DIA	1-5/16 (33)	N/A	1-1/16 (27)	5/8 L x 5/8 W (16 L x 16 W)	Zinc	(1) #8-32 x 1in Truss Head Machine Screw (1) #8-32 x 1-1/2in Truss Head Machine Screw	N/A
BP55270G10	Knob	Satin Nickel	1-5/16 (33) DIA	1-5/16 (33)	N/A	1-1/16 (27)	5/8 L x 5/8 W (16 L x 16 W)	Zinc	(1) #8-32 x 1in Truss Head Machine Screw (1) #8-32 x 1-1/2in Truss Head Machine Screw	N/A
BP55270GM	Knob	Gunmetal	1-5/16 (33) DIA	1-5/16 (33)	N/A	1-1/16 (27)	5/8 L x 5/8 W (16 L x 16 W)	Zinc	(1) #8-32 x 1in Truss Head Machine Screw (1) #8-32 x 1-1/2in Truss Head Machine Screw	N/A
BP55270ORB	Knob	Oil-Rubbed Bronze	1-5/16 (33) DIA	1-5/16 (33)	N/A	1-1/16 (27)	5/8 L x 5/8 W (16 L x 16 W)	Zinc	(1) #8-32 x 1in Truss Head Machine Screw (1) #8-32 x 1-1/2in Truss Head Machine Screw	N/A
BP55270PN	Knob	Polished Nickel	1-5/16 (33) DIA	1-5/16 (33)	N/A	1-1/16 (27)	5/8 L x 5/8 W (16 L x 16 W)	Zinc	(1) #8-32 x 1in Truss Head Machine Screw (1) #8-32 x 1-1/2in Truss Head Machine Screw	N/A
BP5527126	Knob	Polished Chrome	1-3/16 (30) LGTH	1-3/16 (30)	1-3/16 (30)	1-1/16 (27)	5/8 L x 5/8 W (16 L x 16 W)	Zinc	(1) #8-32 x 1in Truss Head Machine Screw (1) #8-32 x 1-1/2in Truss Head Machine Screw	N/A
BP55271BBR	Knob	Black Bronze	1-3/16 (30) LGTH	1-3/16 (30)	1-3/16 (30)	1-1/16 (27)	5/8 L x 5/8 W (16 L x 16 W)	Zinc	(1) #8-32 x 1in Truss Head Machine Screw (1) #8-32 x 1-1/2in Truss Head Machine Screw	N/A
BP55271BBZ	Knob	Golden Champagne	1-3/16 (30) LGTH	1-3/16 (30)	1-3/16 (30)	1-1/16 (27)	5/8 L x 5/8 W (16 L x 16 W)	Zinc	(1) #8-32 x 1in Truss Head Machine Screw (1) #8-32 x 1-1/2in Truss Head Machine Screw	N/A
BP55271CZ	Knob	Champagne Bronze	1-3/16 (30) LGTH	1-3/16 (30)	1-3/16 (30)	1-1/16 (27)	5/8 L x 5/8 W (16 L x 16 W)	Zinc	(1) #8-32 x 1in Truss Head Machine Screw (1) #8-32 x 1-1/2in Truss Head Machine Screw	N/A
BP55271G10	Knob	Satin Nickel	1-3/16 (30) LGTH	1-3/16 (30)	1-3/16 (30)	1-1/16 (27)	5/8 L x 5/8 W (16 L x 16 W)	Zinc	(1) #8-32 x 1in Truss Head Machine Screw (1) #8-32 x 1-1/2in Truss Head Machine Screw	N/A
BP55271GM	Knob	Gunmetal	1-3/16 (30) LGTH	1-3/16 (30)	1-3/16 (30)	1-1/16 (27)	5/8 L x 5/8 W (16 L x 16 W)	Zinc	(1) #8-32 x 1in Truss Head Machine Screw (1) #8-32 x 1-1/2in Truss Head Machine Screw	N/A
BP55271ORB	Knob	Oil-Rubbed Bronze	1-3/16 (30) LGTH	1-3/16 (30)	1-3/16 (30)	1-1/16 (27)	5/8 L x 5/8 W (16 L x 16 W)	Zinc	(1) #8-32 x 1in Truss Head Machine Screw (1) #8-32 x 1-1/2in Truss Head Machine Screw	N/A
BP55271PN	Knob	Polished Nickel	1-3/16 (30) LGTH	1-3/16 (30)	1-3/16 (30)	1-1/16 (27)	5/8 L x 5/8 W (16 L x 16 W)	Zinc	(1) #8-32 x 1in Truss Head Machine Screw (1) #8-32 x 1-1/2in Truss Head Machine Screw	N/A
BP5527226	Knob	Polished Chrome	1-5/8 (41) DIA	1-5/8 (41)	N/A	1-5/16 (33)	3/4 L x 3/4 W (19 L x 19 W)	Zinc	(1) #8-32 x 1in Truss Head Machine Screw (1) #8-32 x 1-1/2in Truss Head Machine Screw	N/A
BP55272BBR	Knob	Black Bronze	1-5/8 (41) DIA	1-5/8 (41)	N/A	1-5/16 (33)	3/4 L x 3/4 W (19 L x 19 W)	Zinc	(1) #8-32 x 1in Truss Head Machine Screw (1) #8-32 x 1-1/2in Truss Head Machine Screw	N/A
BP55272BBZ	Knob	Golden Champagne	1-5/8 (41) DIA	1-5/8 (41)	N/A	1-5/16 (33)	3/4 L x 3/4 W (19 L x 19 W)	Zinc	(1) #8-32 x 1in Truss Head Machine Screw (1) #8-32 x 1-1/2in Truss Head Machine Screw	N/A

Mounting hardware included.  
The dimensional information provided here should be verified with the actual product prior to drilling or attempting to install the hardware.  
Please direct any questions you may have on the installation process to Amerock Customer Service (see back cover for contact information).

# PRODUCT INDEX

Product No.	Type	Finish	Product Detail in (mm)	Length in (mm)	Width in (mm)	Projection in (mm)	Base Dimensions in (mm)	Base Material	Mounting Hardware Included	ADA-Friendly
<b>Blackrock (continued) • p. 28</b>										
BP55272CZ	Knob	Champagne Bronze	1-5/8 (41) DIA	1-5/8 (41)	N/A	1-5/16 (33)	3/4 L x 3/4 W (19 L x 19 W)	Zinc	(1) #8-32 x 1in Truss Head Machine Screw (1) #8-32 x 1-1/2in Truss Head Machine Screw	N/A
BP55272G10	Knob	Satin Nickel	1-5/8 (41) DIA	1-5/8 (41)	N/A	1-5/16 (33)	3/4 L x 3/4 W (19 L x 19 W)	Zinc	(1) #8-32 x 1in Truss Head Machine Screw (1) #8-32 x 1-1/2in Truss Head Machine Screw	N/A
BP55272GM	Knob	Gunmetal	1-5/8 (41) DIA	1-5/8 (41)	N/A	1-5/16 (33)	3/4 L x 3/4 W (19 L x 19 W)	Zinc	(1) #8-32 x 1in Truss Head Machine Screw (1) #8-32 x 1-1/2in Truss Head Machine Screw	N/A
BP55272ORB	Knob	Oil-Rubbed Bronze	1-5/8 (41) DIA	1-5/8 (41)	N/A	1-5/16 (33)	3/4 L x 3/4 W (19 L x 19 W)	Zinc	(1) #8-32 x 1in Truss Head Machine Screw (1) #8-32 x 1-1/2in Truss Head Machine Screw	N/A
BP55272PN	Knob	Polished Nickel	1-5/8 (41) DIA	1-5/8 (41)	N/A	1-5/16 (33)	3/4 L x 3/4 W (19 L x 19 W)	Zinc	(1) #8-32 x 1in Truss Head Machine Screw (1) #8-32 x 1-1/2in Truss Head Machine Screw	N/A
BP5527326	Knob	Polished Chrome	1-1/2 (38) LGTH	1-1/2 (38)	1-1/2 (38)	1-5/16 (33)	13/16 L x 13/16 W (21 L x 21 W)	Zinc	(1) #8-32 x 1in Truss Head Machine Screw (1) #8-32 x 1-1/2in Truss Head Machine Screw	N/A
BP55273BBR	Knob	Black Bronze	1-1/2 (38) LGTH	1-1/2 (38)	1-1/2 (38)	1-5/16 (33)	13/16 L x 13/16 W (21 L x 21 W)	Zinc	(1) #8-32 x 1in Truss Head Machine Screw (1) #8-32 x 1-1/2in Truss Head Machine Screw	N/A
BP55273BBZ	Knob	Golden Champagne	1-1/2 (38) LGTH	1-1/2 (38)	1-1/2 (38)	1-5/16 (33)	13/16 L x 13/16 W (21 L x 21 W)	Zinc	(1) #8-32 x 1in Truss Head Machine Screw (1) #8-32 x 1-1/2in Truss Head Machine Screw	N/A
BP55273CZ	Knob	Champagne Bronze	1-1/2 (38) LGTH	1-1/2 (38)	1-1/2 (38)	1-5/16 (33)	13/16 L x 13/16 W (21 L x 21 W)	Zinc	(1) #8-32 x 1in Truss Head Machine Screw (1) #8-32 x 1-1/2in Truss Head Machine Screw	N/A
BP55273G10	Knob	Satin Nickel	1-1/2 (38) LGTH	1-1/2 (38)	1-1/2 (38)	1-5/16 (33)	13/16 L x 13/16 W (21 L x 21 W)	Zinc	(1) #8-32 x 1in Truss Head Machine Screw (1) #8-32 x 1-1/2in Truss Head Machine Screw	N/A
BP55273GM	Knob	Gunmetal	1-1/2 (38) LGTH	1-1/2 (38)	1-1/2 (38)	1-5/16 (33)	13/16 L x 13/16 W (21 L x 21 W)	Zinc	(1) #8-32 x 1in Truss Head Machine Screw (1) #8-32 x 1-1/2in Truss Head Machine Screw	N/A
BP55273ORB	Knob	Oil-Rubbed Bronze	1-1/2 (38) LGTH	1-1/2 (38)	1-1/2 (38)	1-5/16 (33)	13/16 L x 13/16 W (21 L x 21 W)	Zinc	(1) #8-32 x 1in Truss Head Machine Screw (1) #8-32 x 1-1/2in Truss Head Machine Screw	N/A
BP55273PN	Knob	Polished Nickel	1-1/2 (38) LGTH	1-1/2 (38)	1-1/2 (38)	1-5/16 (33)	13/16 L x 13/16 W (21 L x 21 W)	Zinc	(1) #8-32 x 1in Truss Head Machine Screw (1) #8-32 x 1-1/2in Truss Head Machine Screw	N/A
BP5527426	Pendant	Polished Chrome	1-13/16 (46) LGTH	1-13/16 (46)	1-3/8 (35)	5/8 (16)	5/8 L x 5/8 W (16 L x 16 W)	Zinc	(1) #8-32 x 1in Truss Head Machine Screw (1) #8-32 x 1-1/2in Truss Head Machine Screw	N/A
BP55274BBR	Pendant	Black Bronze	1-13/16 (46) LGTH	1-13/16 (46)	1-3/8 (35)	5/8 (16)	5/8 L x 5/8 W (16 L x 16 W)	Zinc	(1) #8-32 x 1in Truss Head Machine Screw (1) #8-32 x 1-1/2in Truss Head Machine Screw	N/A
BP55274BBZ	Pendant	Golden Champagne	1-13/16 (46) LGTH	1-13/16 (46)	1-3/8 (35)	5/8 (16)	5/8 L x 5/8 W (16 L x 16 W)	Zinc	(1) #8-32 x 1in Truss Head Machine Screw (1) #8-32 x 1-1/2in Truss Head Machine Screw	N/A
BP55274CZ	Pendant	Champagne Bronze	1-13/16 (46) LGTH	1-13/16 (46)	1-3/8 (35)	5/8 (16)	5/8 L x 5/8 W (16 L x 16 W)	Zinc	(1) #8-32 x 1in Truss Head Machine Screw (1) #8-32 x 1-1/2in Truss Head Machine Screw	N/A
BP55274G10	Pendant	Satin Nickel	1-13/16 (46) LGTH	1-13/16 (46)	1-3/8 (35)	5/8 (16)	5/8 L x 5/8 W (16 L x 16 W)	Zinc	(1) #8-32 x 1in Truss Head Machine Screw (1) #8-32 x 1-1/2in Truss Head Machine Screw	N/A
BP55274GM	Pendant	Gunmetal	1-13/16 (46) LGTH	1-13/16 (46)	1-3/8 (35)	5/8 (16)	5/8 L x 5/8 W (16 L x 16 W)	Zinc	(1) #8-32 x 1in Truss Head Machine Screw (1) #8-32 x 1-1/2in Truss Head Machine Screw	N/A
BP55274ORB	Pendant	Oil-Rubbed Bronze	1-13/16 (46) LGTH	1-13/16 (46)	1-3/8 (35)	5/8 (16)	5/8 L x 5/8 W (16 L x 16 W)	Zinc	(1) #8-32 x 1in Truss Head Machine Screw (1) #8-32 x 1-1/2in Truss Head Machine Screw	N/A
BP55274PN	Pendant	Polished Nickel	1-13/16 (46) LGTH	1-13/16 (46)	1-3/8 (35)	5/8 (16)	5/8 L x 5/8 W (16 L x 16 W)	Zinc	(1) #8-32 x 1in Truss Head Machine Screw (1) #8-32 x 1-1/2in Truss Head Machine Screw	N/A
BP5527526	Pull	Polished Chrome	3 (76) CTC	3-3/4 (96)	9/16 (14)	1-1/16 (27)	5/8 L x 9/16 W (16 L x 14 W)	Zinc	(2) #8-32 x 1in Truss Head Machine Screw (2) #8-32 x 1-1/2in Truss Head Machine Screw	N/A
BP55275BBR	Pull	Black Bronze	3 (76) CTC	3-3/4 (96)	9/16 (14)	1-1/16 (27)	5/8 L x 9/16 W (16 L x 14 W)	Zinc	(2) #8-32 x 1in Truss Head Machine Screw (2) #8-32 x 1-1/2in Truss Head Machine Screw	N/A
BP55275BBZ	Pull	Golden Champagne	3 (76) CTC	3-3/4 (96)	9/16 (14)	1-1/16 (27)	5/8 L x 9/16 W (16 L x 14 W)	Zinc	(2) #8-32 x 1in Truss Head Machine Screw (2) #8-32 x 1-1/2in Truss Head Machine Screw	N/A
BP55275CZ	Pull	Champagne Bronze	3 (76) CTC	3-3/4 (96)	9/16 (14)	1-1/16 (27)	5/8 L x 9/16 W (16 L x 14 W)	Zinc	(2) #8-32 x 1in Truss Head Machine Screw (2) #8-32 x 1-1/2in Truss Head Machine Screw	N/A

Mounting hardware included.  
The dimensional information provided here should be verified with the actual product prior to drilling or attempting to install the hardware.  
Please direct any questions you may have on the installation process to Amerock Customer Service (see back cover for contact information).

# PRODUCT INDEX

Product No.	Type	Finish	Product Detail in (mm)	Length in (mm)	Width in (mm)	Projection in (mm)	Base Dimensions in (mm)	Base Material	Mounting Hardware Included	ADA-Friendly
<b>Blackrock (continued) • p. 28</b>										
BP55275G10	Pull	Satin Nickel	3 (76) CTC	3-3/4 (96)	9/16 (14)	1-1/16 (27)	5/8 L x 9/16 W (16 L x 14 W)	Zinc	(2) #8-32 x 1in Truss Head Machine Screw (2) #8-32 x 1-1/2in Truss Head Machine Screw	N/A
BP55275GM	Pull	Gunmetal	3 (76) CTC	3-3/4 (96)	9/16 (14)	1-1/16 (27)	5/8 L x 9/16 W (16 L x 14 W)	Zinc	(2) #8-32 x 1in Truss Head Machine Screw (2) #8-32 x 1-1/2in Truss Head Machine Screw	N/A
BP55275ORB	Pull	Oil-Rubbed Bronze	3 (76) CTC	3-3/4 (96)	9/16 (14)	1-1/16 (27)	5/8 L x 9/16 W (16 L x 14 W)	Zinc	(2) #8-32 x 1in Truss Head Machine Screw (2) #8-32 x 1-1/2in Truss Head Machine Screw	N/A
BP55275PN	Pull	Polished Nickel	3 (76) CTC	3-3/4 (96)	9/16 (14)	1-1/16 (27)	5/8 L x 9/16 W (16 L x 14 W)	Zinc	(2) #8-32 x 1in Truss Head Machine Screw (2) #8-32 x 1-1/2in Truss Head Machine Screw	N/A
BP5527626	Pull	Polished Chrome	3-3/4 (96) CTC	4-5/8 (117)	9/16 (14)	1-3/16 (30)	5/8 L x 9/16 W (16 L x 14 W)	Zinc	(2) #8-32 x 1in Truss Head Machine Screw (2) #8-32 x 1-1/2in Truss Head Machine Screw	✓
BP55276BBR	Pull	Black Bronze	3-3/4 (96) CTC	4-5/8 (117)	9/16 (14)	1-3/16 (30)	5/8 L x 9/16 W (16 L x 14 W)	Zinc	(2) #8-32 x 1in Truss Head Machine Screw (2) #8-32 x 1-1/2in Truss Head Machine Screw	✓
BP55276BBZ	Pull	Golden Champagne	3-3/4 (96) CTC	4-5/8 (117)	9/16 (14)	1-3/16 (30)	5/8 L x 9/16 W (16 L x 14 W)	Zinc	(2) #8-32 x 1in Truss Head Machine Screw (2) #8-32 x 1-1/2in Truss Head Machine Screw	✓
BP55276CZ	Pull	Champagne Bronze	3-3/4 (96) CTC	4-5/8 (117)	9/16 (14)	1-3/16 (30)	5/8 L x 9/16 W (16 L x 14 W)	Zinc	(2) #8-32 x 1in Truss Head Machine Screw (2) #8-32 x 1-1/2in Truss Head Machine Screw	✓
BP55276G10	Pull	Satin Nickel	3-3/4 (96) CTC	4-5/8 (117)	9/16 (14)	1-3/16 (30)	5/8 L x 9/16 W (16 L x 14 W)	Zinc	(2) #8-32 x 1in Truss Head Machine Screw (2) #8-32 x 1-1/2in Truss Head Machine Screw	✓
BP55276GM	Pull	Gunmetal	3-3/4 (96) CTC	4-5/8 (117)	9/16 (14)	1-3/16 (30)	5/8 L x 9/16 W (16 L x 14 W)	Zinc	(2) #8-32 x 1in Truss Head Machine Screw (2) #8-32 x 1-1/2in Truss Head Machine Screw	✓
BP55276ORB	Pull	Oil-Rubbed Bronze	3-3/4 (96) CTC	4-5/8 (117)	9/16 (14)	1-3/16 (30)	5/8 L x 9/16 W (16 L x 14 W)	Zinc	(2) #8-32 x 1in Truss Head Machine Screw (2) #8-32 x 1-1/2in Truss Head Machine Screw	✓
BP55276PN	Pull	Polished Nickel	3-3/4 (96) CTC	4-5/8 (117)	9/16 (14)	1-3/16 (30)	5/8 L x 9/16 W (16 L x 14 W)	Zinc	(2) #8-32 x 1in Truss Head Machine Screw (2) #8-32 x 1-1/2in Truss Head Machine Screw	✓
BP5527726	Pull	Polished Chrome	5-1/16 (128) CTC	5-15/16 (151)	5/8 (16)	1-3/16 (30)	11/16 L x 9/16 W (17 L x 14 W)	Zinc	(2) #8-32 x 1in Truss Head Machine Screw (2) #8-32 x 1-1/2in Truss Head Machine Screw	✓
BP55277BBR	Pull	Black Bronze	5-1/16 (128) CTC	5-15/16 (151)	5/8 (16)	1-3/16 (30)	11/16 L x 9/16 W (17 L x 14 W)	Zinc	(2) #8-32 x 1in Truss Head Machine Screw (2) #8-32 x 1-1/2in Truss Head Machine Screw	✓
BP55277BBZ	Pull	Golden Champagne	5-1/16 (128) CTC	5-15/16 (151)	5/8 (16)	1-3/16 (30)	11/16 L x 9/16 W (17 L x 14 W)	Zinc	(2) #8-32 x 1in Truss Head Machine Screw (2) #8-32 x 1-1/2in Truss Head Machine Screw	✓
BP55277CZ	Pull	Champagne Bronze	5-1/16 (128) CTC	5-15/16 (151)	5/8 (16)	1-3/16 (30)	11/16 L x 9/16 W (17 L x 14 W)	Zinc	(2) #8-32 x 1in Truss Head Machine Screw (2) #8-32 x 1-1/2in Truss Head Machine Screw	✓
BP55277G10	Pull	Satin Nickel	5-1/16 (128) CTC	5-15/16 (151)	5/8 (16)	1-3/16 (30)	11/16 L x 9/16 W (17 L x 14 W)	Zinc	(2) #8-32 x 1in Truss Head Machine Screw (2) #8-32 x 1-1/2in Truss Head Machine Screw	✓
BP55277GM	Pull	Gunmetal	5-1/16 (128) CTC	5-15/16 (151)	5/8 (16)	1-3/16 (30)	11/16 L x 9/16 W (17 L x 14 W)	Zinc	(2) #8-32 x 1in Truss Head Machine Screw (2) #8-32 x 1-1/2in Truss Head Machine Screw	✓
BP55277ORB	Pull	Oil-Rubbed Bronze	5-1/16 (128) CTC	5-15/16 (151)	5/8 (16)	1-3/16 (30)	11/16 L x 9/16 W (17 L x 14 W)	Zinc	(2) #8-32 x 1in Truss Head Machine Screw (2) #8-32 x 1-1/2in Truss Head Machine Screw	✓
BP55277PN	Pull	Polished Nickel	5-1/16 (128) CTC	5-15/16 (151)	5/8 (16)	1-3/16 (30)	11/16 L x 9/16 W (17 L x 14 W)	Zinc	(2) #8-32 x 1in Truss Head Machine Screw (2) #8-32 x 1-1/2in Truss Head Machine Screw	✓
BP5527826	Pull	Polished Chrome	6-5/16 (160) CTC	7-1/4 (184)	5/8 (16)	1-1/4 (32)	11/16 L x 5/8 W (17 L x 16 W)	Zinc	(2) #8-32 x 1in Truss Head Machine Screw (2) #8-32 x 1-1/2in Truss Head Machine Screw	✓
BP55278BBR	Pull	Black Bronze	6-5/16 (160) CTC	7-1/4 (184)	5/8 (16)	1-1/4 (32)	11/16 L x 5/8 W (17 L x 16 W)	Zinc	(2) #8-32 x 1in Truss Head Machine Screw (2) #8-32 x 1-1/2in Truss Head Machine Screw	✓
BP55278BBZ	Pull	Golden Champagne	6-5/16 (160) CTC	7-1/4 (184)	5/8 (16)	1-1/4 (32)	11/16 L x 5/8 W (17 L x 16 W)	Zinc	(2) #8-32 x 1in Truss Head Machine Screw (2) #8-32 x 1-1/2in Truss Head Machine Screw	✓
BP55278CZ	Pull	Champagne Bronze	6-5/16 (160) CTC	7-1/4 (184)	5/8 (16)	1-1/4 (32)	11/16 L x 5/8 W (17 L x 16 W)	Zinc	(2) #8-32 x 1in Truss Head Machine Screw (2) #8-32 x 1-1/2in Truss Head Machine Screw	✓
BP55278G10	Pull	Satin Nickel	6-5/16 (160) CTC	7-1/4 (184)	5/8 (16)	1-1/4 (32)	11/16 L x 5/8 W (17 L x 16 W)	Zinc	(2) #8-32 x 1in Truss Head Machine Screw (2) #8-32 x 1-1/2in Truss Head Machine Screw	✓

Mounting hardware included.  
The dimensional information provided here should be verified with the actual product prior to drilling or attempting to install the hardware.  
Please direct any questions you may have on the installation process to Amerock Customer Service (see back cover for contact information).

# PRODUCT INDEX

Product No.	Type	Finish	Product Detail in (mm)	Length in (mm)	Width in (mm)	Projection in (mm)	Base Dimensions in (mm)	Base Material	Mounting Hardware Included	ADA-Friendly
<b>Blackrock (continued) • p. 28</b>										
BP55278GM	Pull	Gunmetal	6-5/16 (160) CTC	7-1/4 (184)	5/8 (16)	1-1/4 (32)	11/16 L x 5/8 W (17 L x 16 W)	Zinc	(2) #8-32 x 1in Truss Head Machine Screw (2) #8-32 x 1-1/2in Truss Head Machine Screw	✓
BP55278ORB	Pull	Oil-Rubbed Bronze	6-5/16 (160) CTC	7-1/4 (184)	5/8 (16)	1-1/4 (32)	11/16 L x 5/8 W (17 L x 16 W)	Zinc	(2) #8-32 x 1in Truss Head Machine Screw (2) #8-32 x 1-1/2in Truss Head Machine Screw	✓
BP55278PN	Pull	Polished Nickel	6-5/16 (160) CTC	7-1/4 (184)	5/8 (16)	1-1/4 (32)	11/16 L x 5/8 W (17 L x 16 W)	Zinc	(2) #8-32 x 1in Truss Head Machine Screw (2) #8-32 x 1-1/2in Truss Head Machine Screw	✓
BP55279BBR	Appliance Pull	Black Bronze	8 (203) CTC	9-3/8 (238)	3/4 (19)	1-11/16 (43)	15/16 L x 3/4 W (24 L x 19 W)	Zinc	(2) #10-24 x 3/4in Pan Head Machine Screw (2) #10-24 x 1in Pan Head Machine Screw (2) #10-24 x 1-1/4in Pan Head Machine Screw (2) #10-24 x 1-1/2in Pan Head Machine Screw (2) #10-24 x 1-3/4in Pan Head Machine Screw	✓
BP55279BBZ	Appliance Pull	Golden Champagne	8 (203) CTC	9-3/8 (238)	3/4 (19)	1-11/16 (43)	15/16 L x 3/4 W (24 L x 19 W)	Zinc	(2) #10-24 x 3/4in Pan Head Machine Screw (2) #10-24 x 1in Pan Head Machine Screw (2) #10-24 x 1-1/4in Pan Head Machine Screw (2) #10-24 x 1-1/2in Pan Head Machine Screw (2) #10-24 x 1-3/4in Pan Head Machine Screw	✓
BP55279G10	Appliance Pull	Satin Nickel	8 (203) CTC	9-3/8 (238)	3/4 (19)	1-11/16 (43)	15/16 L x 3/4 W (24 L x 19 W)	Zinc	(2) #10-24 x 3/4in Pan Head Machine Screw (2) #10-24 x 1in Pan Head Machine Screw (2) #10-24 x 1-1/4in Pan Head Machine Screw (2) #10-24 x 1-1/2in Pan Head Machine Screw (2) #10-24 x 1-3/4in Pan Head Machine Screw	✓
BP55279ORB	Appliance Pull	Oil-Rubbed Bronze	8 (203) CTC	9-3/8 (238)	3/4 (19)	1-11/16 (43)	15/16 L x 3/4 W (24 L x 19 W)	Zinc	(2) #10-24 x 3/4in Pan Head Machine Screw (2) #10-24 x 1in Pan Head Machine Screw (2) #10-24 x 1-1/4in Pan Head Machine Screw (2) #10-24 x 1-1/2in Pan Head Machine Screw (2) #10-24 x 1-3/4in Pan Head Machine Screw	✓
BP55279PN	Appliance Pull	Polished Nickel	8 (203) CTC	9-3/8 (238)	3/4 (19)	1-11/16 (43)	15/16 L x 3/4 W (24 L x 19 W)	Zinc	(2) #10-24 x 3/4in Pan Head Machine Screw (2) #10-24 x 1in Pan Head Machine Screw (2) #10-24 x 1-1/4in Pan Head Machine Screw (2) #10-24 x 1-1/2in Pan Head Machine Screw (2) #10-24 x 1-3/4in Pan Head Machine Screw	✓
BP55280BBR	Appliance Pull	Black Bronze	12 (305) CTC	13-5/16 (338)	3/4 (19)	1-11/16 (43)	15/16 L x 3/4 W (24 L x 19 W)	Zinc	(2) #10-24 x 3/4in Pan Head Machine Screw (2) #10-24 x 1in Pan Head Machine Screw (2) #10-24 x 1-1/4in Pan Head Machine Screw (2) #10-24 x 1-1/2in Pan Head Machine Screw (2) #10-24 x 1-3/4in Pan Head Machine Screw	✓
BP55280BBZ	Appliance Pull	Golden Champagne	12 (305) CTC	13-3/16 (338)	3/4 (19)	1-11/16 (43)	15/16 L x 3/4 W (24 L x 19 W)	Zinc	(2) #10-24 x 3/4in Pan Head Machine Screw (2) #10-24 x 1in Pan Head Machine Screw (2) #10-24 x 1-1/4in Pan Head Machine Screw (2) #10-24 x 1-1/2in Pan Head Machine Screw (2) #10-24 x 1-3/4in Pan Head Machine Screw	✓
BP55280G10	Appliance Pull	Satin Nickel	12 (305) CTC	13-5/16 (338)	3/4 (19)	1-11/16 (43)	15/16 L x 3/4 W (24 L x 19 W)	Zinc	(2) #10-24 x 3/4in Pan Head Machine Screw (2) #10-24 x 1in Pan Head Machine Screw (2) #10-24 x 1-1/4in Pan Head Machine Screw (2) #10-24 x 1-1/2in Pan Head Machine Screw (2) #10-24 x 1-3/4in Pan Head Machine Screw	✓
BP55280ORB	Appliance Pull	Oil-Rubbed Bronze	12 (305) CTC	13-5/16 (338)	3/4 (19)	1-11/16 (43)	15/16 L x 3/4 W (24 L x 19 W)	Zinc	(2) #10-24 x 3/4in Pan Head Machine Screw (2) #10-24 x 1in Pan Head Machine Screw (2) #10-24 x 1-1/4in Pan Head Machine Screw (2) #10-24 x 1-1/2in Pan Head Machine Screw (2) #10-24 x 1-3/4in Pan Head Machine Screw	✓
BP55280PN	Appliance Pull	Polished Nickel	12 (305) CTC	13-3/16 (338)	3/4 (19)	1-11/16 (43)	15/16 L x 3/4 W (24 L x 19 W)	Zinc	(2) #10-24 x 3/4in Pan Head Machine Screw (2) #10-24 x 1in Pan Head Machine Screw (2) #10-24 x 1-1/4in Pan Head Machine Screw (2) #10-24 x 1-1/2in Pan Head Machine Screw (2) #10-24 x 1-3/4in Pan Head Machine Screw	✓

Mounting hardware included.

The dimensional information provided here should be verified with the actual product prior to drilling or attempting to install the hardware. Please direct any questions you may have on the installation process to Amerock Customer Service (see back cover for contact information).

# PRODUCT INDEX

Product No.	Type	Finish	Product Detail in (mm)	Length in (mm)	Width in (mm)	Projection in (mm)	Base Dimensions in (mm)	Base Material	Mounting Hardware Included	ADA-Friendly
<b>Blackrock (continued) • p. 28</b>										
BP55281BBR	Appliance Pull	Black Bronze	18 (457) CTC	19-3/8 (492)	3/4 (19)	1-11/16 (43)	15/16 L x 3/4 W (24 L x 19 W)	Zinc	(2) #10-24 x 3/4in Pan Head Machine Screw (2) #10-24 x 1in Pan Head Machine Screw (2) #10-24 x 1-1/4in Pan Head Machine Screw (2) #10-24 x 1-1/2in Pan Head Machine Screw (2) #10-24 x 1-3/4in Pan Head Machine Screw	✓
BP55281BBZ	Appliance Pull	Golden Champagne	18 (457) CTC	19-3/8 (492)	3/4 (19)	1-11/16 (43)	15/16 L x 3/4 W (24 L x 19 W)	Zinc	(2) #10-24 x 3/4in Pan Head Machine Screw (2) #10-24 x 1in Pan Head Machine Screw (2) #10-24 x 1-1/4in Pan Head Machine Screw (2) #10-24 x 1-1/2in Pan Head Machine Screw (2) #10-24 x 1-3/4in Pan Head Machine Screw	✓
BP55281G10	Appliance Pull	Satin Nickel	18 (457) CTC	19-3/8 (492)	3/4 (19)	1-11/16 (43)	15/16 L x 3/4 W (24 L x 19 W)	Zinc	(2) #10-24 x 3/4in Pan Head Machine Screw (2) #10-24 x 1in Pan Head Machine Screw (2) #10-24 x 1-1/4in Pan Head Machine Screw (2) #10-24 x 1-1/2in Pan Head Machine Screw (2) #10-24 x 1-3/4in Pan Head Machine Screw	✓
BP55281ORB	Appliance Pull	Oil-Rubbed Bronze	18 (457) CTC	19-3/8 (492)	3/4 (19)	1-11/16 (43)	15/16 L x 3/4 W (24 L x 19 W)	Zinc	(2) #10-24 x 3/4in Pan Head Machine Screw (2) #10-24 x 1in Pan Head Machine Screw (2) #10-24 x 1-1/4in Pan Head Machine Screw (2) #10-24 x 1-1/2in Pan Head Machine Screw (2) #10-24 x 1-3/4in Pan Head Machine Screw	✓
BP55281PN	Appliance Pull	Polished Nickel	18 (457) CTC	19-3/8 (492)	3/4 (19)	1-11/16 (43)	15/16 L x 3/4 W (24 L x 19 W)	Zinc	(2) #10-24 x 3/4in Pan Head Machine Screw (2) #10-24 x 1in Pan Head Machine Screw (2) #10-24 x 1-1/4in Pan Head Machine Screw (2) #10-24 x 1-1/2in Pan Head Machine Screw (2) #10-24 x 1-3/4in Pan Head Machine Screw	✓
<b>Davenport • p. 30</b>										
BH3605026	Robe Hook	Chrome	Double	2-15/16 (75)	5/8 (16)	3 (76)	1-1/16 L x 2-5/16 W (27 L x 59 W)	Zinc	(2) #8 x 1-1/4 in. Sheet Metal Screw (1) Mounting Bracket	N/A
BH36050BBZ	Robe Hook	Golden Champagne	Double	2-15/16 (75)	5/8 (16)	3 (76)	1-1/16 L x 2-5/16 W (27 L x 59 W)	Zinc	(2) #8 x 1-1/4 in. Sheet Metal Screw (1) Mounting Bracket	N/A
BH36050CZ	Robe Hook	Champagne Bronze	Double	2-15/16 (75)	5/8 (16)	3 (76)	1-1/16 L x 2-5/16 W (27 L x 59 W)	Zinc	(2) #8 x 1-1/4 in. Sheet Metal Screw (1) Mounting Bracket	N/A
BH36050G10	Robe Hook	Brushed Nickel	Double	2-15/16 (75)	5/8 (16)	3 (76)	1-1/16 L x 2-5/16 W (27 L x 59 W)	Zinc	(2) #8 x 1-1/4 in. Sheet Metal Screw (1) Mounting Bracket	N/A
BH36050MB	Robe Hook	Matte Black	Double	2-15/16 (75)	5/8 (16)	3 (76)	1-1/16 L x 2-5/16 W (27 L x 59 W)	Zinc	(2) #8 x 1-1/4 in. Sheet Metal Screw (1) Mounting Bracket	N/A
BH36050ORB	Robe Hook	Oil-Rubbed Bronze	Double	2-15/16 (75)	5/8 (16)	3 (76)	1-1/16 L x 2-5/16 W (27 L x 59 W)	Zinc	(2) #8 x 1-1/4 in. Sheet Metal Screw (1) Mounting Bracket	N/A
BP3660026	Pull	Polished Chrome	3 (76) CTC	4-1/2 (114)	1-1/16 (27)	1-7/16 (37)	1/2 L x 1-1/16 W (13 L x 27 W)	Zinc	(2) #8-32 x 1in Truss Head Machine Screw (2) #8-32 x 1-1/2in Truss Head Machine Screw	N/A
BP36600BBZ	Pull	Golden Champagne	3 (76) CTC	4-1/2 (114)	1-1/16 (27)	1-7/16 (37)	1/2 L x 1-1/16 W (13 L x 27 W)	Zinc	(2) #8-32 x 1in Truss Head Machine Screw (2) #8-32 x 1-1/2in Truss Head Machine Screw	N/A
BP36600CZ	Pull	Champagne Bronze	3 (76) CTC	4-1/2 (114)	1-1/16 (27)	1-7/16 (37)	1/2 L x 1-1/16 W (13 L x 27 W)	Zinc	(2) #8-32 x 1in Truss Head Machine Screw (2) #8-32 x 1-1/2in Truss Head Machine Screw	N/A
BP36600FB	Pull	Matte Black	3 (76) CTC	4-1/2 (114)	1-1/16 (27)	1-7/16 (37)	1/2 L x 1-1/16 W (13 L x 27 W)	Zinc	(2) #8-32 x 1in Truss Head Machine Screw (2) #8-32 x 1-1/2in Truss Head Machine Screw	N/A
BP36600G10	Pull	Satin Nickel	3 (76) CTC	4-1/2 (114)	1-1/16 (27)	1-7/16 (37)	1/2 L x 1-1/16 W (13 L x 27 W)	Zinc	(2) #8-32 x 1in Truss Head Machine Screw (2) #8-32 x 1-1/2in Truss Head Machine Screw	N/A
BP36600GM	Pull	Gunmetal	3 (76) CTC	4-1/2 (114)	1-1/16 (27)	1-7/16 (37)	1/2 L x 1-1/16 W (13 L x 27 W)	Zinc	(2) #8-32 x 1in Truss Head Machine Screw (2) #8-32 x 1-1/2in Truss Head Machine Screw	N/A
BP36600ORB	Pull	Oil-Rubbed Bronze	3 (76) CTC	4-1/2 (114)	1-1/16 (27)	1-7/16 (37)	1/2 L x 1-1/16 W (13 L x 27 W)	Zinc	(2) #8-32 x 1in Truss Head Machine Screw (2) #8-32 x 1-1/2in Truss Head Machine Screw	N/A

Mounting hardware included.  
The dimensional information provided here should be verified with the actual product prior to drilling or attempting to install the hardware.  
Please direct any questions you may have on the installation process to Amerock Customer Service (see back cover for contact information).

# PRODUCT INDEX

Product No.	Type	Finish	Product Detail in (mm)	Length in (mm)	Width in (mm)	Projection in (mm)	Base Dimensions in (mm)	Base Material	Mounting Hardware Included	ADA-Friendly
<b>Davenport (continued) • p. 30</b>										
BP3660126	Knob	Polished Chrome	1-1/4 (32) LGTH	1-1/4 (32)	1 (25)	1-3/16 (30)	1-1/16 L x 7/16 W (27 L x 11 W)	Zinc	(1) #8-32 x 1in Truss Head Machine Screw (1) #8-32 x 1-1/2in Truss Head Machine Screw	N/A
BP36601BBZ	Knob	Golden Champagne	1-1/4 (32) LGTH	1-1/4 (32)	1 (25)	1-3/16 (30)	1-1/16 L x 7/16 W (27 L x 11 W)	Zinc	(1) #8-32 x 1in Truss Head Machine Screw (1) #8-32 x 1-1/2in Truss Head Machine Screw	N/A
BP36601CZ	Knob	Champagne Bronze	1-1/4 (32) LGTH	1-1/4 (32)	1 (25)	1-3/16 (30)	1-1/16 L x 7/16 W (27 L x 11 W)	Zinc	(1) #8-32 x 1in Truss Head Machine Screw (1) #8-32 x 1-1/2in Truss Head Machine Screw	N/A
BP36601G10	Knob	Satin Nickel	1-1/4 (32) LGTH	1-1/4 (32)	1 (25)	1-3/16 (30)	1-1/16 L x 7/16 W (27 L x 11 W)	Zinc	(1) #8-32 x 1in Truss Head Machine Screw (1) #8-32 x 1-1/2in Truss Head Machine Screw	N/A
BP36601GM	Knob	Gunmetal	1-1/4 (32) LGTH	1-1/4 (32)	1 (25)	1-3/16 (30)	1-1/16 L x 7/16 W (27 L x 11 W)	Zinc	(1) #8-32 x 1in Truss Head Machine Screw (1) #8-32 x 1-1/2in Truss Head Machine Screw	N/A
BP36601MB	Knob	Matte Black	1-1/4 (32) LGTH	1-1/4 (32)	1 (25)	1-3/16 (30)	1-1/16 L x 7/16 W (27 L x 11 W)	Zinc	(1) #8-32 x 1in Truss Head Machine Screw (1) #8-32 x 1-1/2in Truss Head Machine Screw	N/A
BP36601ORB	Knob	Oil-Rubbed Bronze	1-1/4 (32) LGTH	1-1/4 (32)	1 (25)	1-3/16 (30)	1-1/16 L x 7/16 W (27 L x 11 W)	Zinc	(1) #8-32 x 1in Truss Head Machine Screw (1) #8-32 x 1-1/2in Truss Head Machine Screw	N/A
BP3660226	Knob	Polished Chrome	1-1/2 (38) LGTH	1-1/2 (38)	1-1/4 (32)	1-3/8 (35)	1-1/8 L x 9/16 W (29 L x 14 W)	Zinc	(1) #8-32 x 1in Truss Head Machine Screw (1) #8-32 x 1-1/2in Truss Head Machine Screw	N/A
BP36602BBZ	Knob	Golden Champagne	1-1/2 (38) LGTH	1-1/2 (38)	1-1/4 (32)	1-3/8 (35)	1-1/8 L x 9/16 W (29 L x 14 W)	Zinc	(1) #8-32 x 1in Truss Head Machine Screw (1) #8-32 x 1-1/2in Truss Head Machine Screw	N/A
BP36602CZ	Knob	Champagne Bronze	1-1/2 (38) LGTH	1-1/2 (38)	1-1/4 (32)	1-3/8 (35)	1-1/8 L x 9/16 W (29 L x 14 W)	Zinc	(1) #8-32 x 1in Truss Head Machine Screw (1) #8-32 x 1-1/2in Truss Head Machine Screw	N/A
BP36602G10	Knob	Satin Nickel	1-1/2 (38) LGTH	1-1/2 (38)	1-1/4 (32)	1-3/8 (35)	1-1/8 L x 9/16 W (29 L x 14 W)	Zinc	(1) #8-32 x 1in Truss Head Machine Screw (1) #8-32 x 1-1/2in Truss Head Machine Screw	N/A
BP36602GM	Knob	Gunmetal	1-1/2 (38) LGTH	1-1/2 (38)	1-1/4 (32)	1-3/8 (35)	1-1/8 L x 9/16 W (29 L x 14 W)	Zinc	(1) #8-32 x 1in Truss Head Machine Screw (1) #8-32 x 1-1/2in Truss Head Machine Screw	N/A
BP36602MB	Knob	Matte Black	1-1/2 (38) LGTH	1-1/2 (38)	1-1/4 (32)	1-3/8 (35)	1-1/8 L x 9/16 W (29 L x 14 W)	Zinc	(1) #8-32 x 1in Truss Head Machine Screw (1) #8-32 x 1-1/2in Truss Head Machine Screw	N/A
BP36602ORB	Knob	Oil-Rubbed Bronze	1-1/2 (38) LGTH	1-1/2 (38)	1-1/4 (32)	1-3/8 (35)	1-1/8 L x 9/16 W (29 L x 14 W)	Zinc	(1) #8-32 x 1in Truss Head Machine Screw (1) #8-32 x 1-1/2in Truss Head Machine Screw	N/A
BP3660526	Pull	Polished Chrome	3-3/4 (96) CTC	5-5/16 (135)	1-1/16 (27)	1-7/16 (37)	1/2 L x 1-1/16 W (13 L x 27 W)	Zinc	(2) #8-32 x 1in Truss Head Machine Screw (2) #8-32 x 1-1/2in Truss Head Machine Screw	N/A
BP36605BBZ	Pull	Golden Champagne	3-3/4 (96) CTC	5-5/16 (135)	1-1/16 (27)	1-7/16 (37)	1/2 L x 1-1/16 W (13 L x 27 W)	Zinc	(2) #8-32 x 1in Truss Head Machine Screw (2) #8-32 x 1-1/2in Truss Head Machine Screw	N/A
BP36605CZ	Pull	Champagne Bronze	3-3/4 (96) CTC	5-5/16 (135)	1-1/16 (27)	1-7/16 (37)	1/2 L x 1-1/16 W (13 L x 27 W)	Zinc	(2) #8-32 x 1in Truss Head Machine Screw (2) #8-32 x 1-1/2in Truss Head Machine Screw	N/A
BP36605G10	Pull	Satin Nickel	3-3/4 (96) CTC	5-5/16 (135)	1-1/16 (27)	1-7/16 (37)	1/2 L x 1-1/16 W (13 L x 27 W)	Zinc	(2) #8-32 x 1in Truss Head Machine Screw (2) #8-32 x 1-1/2in Truss Head Machine Screw	N/A
BP36605GM	Pull	Gunmetal	3-3/4 (96) CTC	5-5/16 (135)	1-1/16 (27)	1-7/16 (37)	1/2 L x 1-1/16 W (13 L x 27 W)	Zinc	(2) #8-32 x 1in Truss Head Machine Screw (2) #8-32 x 1-1/2in Truss Head Machine Screw	N/A
BP36605MB	Pull	Matte Black	3-3/4 (96) CTC	5-5/16 (135)	1-1/16 (27)	1-7/16 (37)	1/2 L x 1-1/16 W (13 L x 27 W)	Zinc	(2) #8-32 x 1in Truss Head Machine Screw (2) #8-32 x 1-1/2in Truss Head Machine Screw	N/A
BP36605ORB	Pull	Oil-Rubbed Bronze	3-3/4 (96) CTC	5-5/16 (135)	1-1/16 (27)	1-7/16 (37)	1/2 L x 1-1/16 W (13 L x 27 W)	Zinc	(2) #8-32 x 1in Truss Head Machine Screw (2) #8-32 x 1-1/2in Truss Head Machine Screw	N/A
BP3660626	Pull	Polished Chrome	5-1/16 (128) CTC	6-9/16 (167)	1-1/16 (27)	1-7/16 (37)	1/2 L x 1-1/16 W (13 L x 27 W)	Zinc	(2) #8-32 x 1in Truss Head Machine Screw (2) #8-32 x 1-1/2in Truss Head Machine Screw	N/A
BP36606BBZ	Pull	Golden Champagne	5-1/16 (128) CTC	6-9/16 (167)	1-1/16 (27)	1-7/16 (37)	1/2 L x 1-1/16 W (13 L x 27 W)	Zinc	(2) #8-32 x 1in Truss Head Machine Screw (2) #8-32 x 1-1/2in Truss Head Machine Screw	N/A
BP36606CZ	Pull	Champagne Bronze	5-1/16 (128) CTC	6-9/16 (167)	1-1/16 (27)	1-7/16 (37)	1/2 L x 1-1/16 W (13 L x 27 W)	Zinc	(2) #8-32 x 1in Truss Head Machine Screw (2) #8-32 x 1-1/2in Truss Head Machine Screw	N/A
BP36606G10	Pull	Satin Nickel	5-1/16 (128) CTC	6-9/16 (167)	1-1/16 (27)	1-7/16 (37)	1/2 L x 1-1/16 W (13 L x 27 W)	Zinc	(2) #8-32 x 1in Truss Head Machine Screw (2) #8-32 x 1-1/2in Truss Head Machine Screw	N/A

Mounting hardware included.  
The dimensional information provided here should be verified with the actual product prior to drilling or attempting to install the hardware.  
Please direct any questions you may have on the installation process to Amerock Customer Service (see back cover for contact information).

# PRODUCT INDEX

Product No.	Type	Finish	Product Detail in (mm)	Length in (mm)	Width in (mm)	Projection in (mm)	Base Dimensions in (mm)	Base Material	Mounting Hardware Included	ADA-Friendly
<b>Davenport (continued) • p. 30</b>										
BP36606GM	Pull	Gunmetal	5-1/16 (128) CTC	6-9/16 (167)	1-1/16 (27)	1-7/16 (37)	1/2 L x 1-1/16 W (13 L x 27 W)	Zinc	(2) #8-32 x 1in Truss Head Machine Screw (2) #8-32 x 1-1/2in Truss Head Machine Screw	N/A
BP36606MB	Pull	Matte Black	5-1/16 (128) CTC	6-9/16 (167)	1-1/16 (27)	1-7/16 (37)	1/2 L x 1-1/16 W (13 L x 27 W)	Zinc	(2) #8-32 x 1in Truss Head Machine Screw (2) #8-32 x 1-1/2in Truss Head Machine Screw	N/A
BP36606ORB	Pull	Oil-Rubbed Bronze	5-1/16 (128) CTC	6-9/16 (167)	1-1/16 (27)	1-7/16 (37)	1/2 L x 1-1/16 W (13 L x 27 W)	Zinc	(2) #8-32 x 1in Truss Head Machine Screw (2) #8-32 x 1-1/2in Truss Head Machine Screw	N/A
BP3660726	Pull	Polished Chrome	6-5/16 (160) CTC	7-13/16 (198)	1-1/16 (27)	1-7/16 (37)	1/2 L x 1-1/16 W (13 L x 27 W)	Zinc	(2) #8-32 x 1in Truss Head Machine Screw (2) #8-32 x 1-1/2in Truss Head Machine Screw	N/A
BP36607BBZ	Pull	Golden Champagne	6-5/16 (160) CTC	7-13/16 (198)	1-1/16 (27)	1-7/16 (37)	1/2 L x 1-1/16 W (13 L x 27 W)	Zinc	(2) #8-32 x 1in Truss Head Machine Screw (2) #8-32 x 1-1/2in Truss Head Machine Screw	N/A
BP36607CZ	Pull	Champagne Bronze	6-5/16 (160) CTC	7-13/16 (198)	1-1/16 (27)	1-7/16 (37)	1/2 L x 1-1/16 W (13 L x 27 W)	Zinc	(2) #8-32 x 1in Truss Head Machine Screw (2) #8-32 x 1-1/2in Truss Head Machine Screw	N/A
BP36607G10	Pull	Satin Nickel	6-5/16 (160) CTC	7-13/16 (198)	1-1/16 (27)	1-7/16 (37)	1/2 L x 1-1/16 W (13 L x 27 W)	Zinc	(2) #8-32 x 1in Truss Head Machine Screw (2) #8-32 x 1-1/2in Truss Head Machine Screw	N/A
BP36607GM	Pull	Gunmetal	6-5/16 (160) CTC	7-13/16 (198)	1-1/16 (27)	1-7/16 (37)	1/2 L x 1-1/16 W (13 L x 27 W)	Zinc	(2) #8-32 x 1in Truss Head Machine Screw (2) #8-32 x 1-1/2in Truss Head Machine Screw	N/A
BP36607MB	Pull	Matte Black	6-5/16 (160) CTC	7-13/16 (198)	1-1/16 (27)	1-7/16 (37)	1/2 L x 1-1/16 W (13 L x 27 W)	Zinc	(2) #8-32 x 1in Truss Head Machine Screw (2) #8-32 x 1-1/2in Truss Head Machine Screw	N/A
BP36607ORB	Pull	Oil-Rubbed Bronze	6-5/16 (160) CTC	7-13/16 (198)	1-1/16 (27)	1-7/16 (37)	1/2 L x 1-1/16 W (13 L x 27 W)	Zinc	(2) #8-32 x 1in Truss Head Machine Screw (2) #8-32 x 1-1/2in Truss Head Machine Screw	N/A
<b>Highland Ridge • p. 32</b>										
BH3601026	Robe Hook	Chrome	Single	2-5/8 (67)	1-3/4 (44)	2-1/2 (64)	2-5/8 L x 1-3/4 W (67 L x 44 W)	Zinc	(2) #8 x 1-1/4 in. Sheet Metal Screw (1) Mounting Bracket	N/A
BH36010BBZ	Robe Hook	Golden Champagne	Single	2-5/8 (67)	1-3/4 (44)	2-1/2 (64)	2-5/8 L x 1-3/4 W (67 L x 44 W)	Zinc	(2) #8 x 1-1/4 in. Sheet Metal Screw (1) Mounting Bracket	N/A
BH36010CZ	Robe Hook	Champagne Bronze	Single	2-5/8 (67)	1-3/4 (44)	2-1/2 (64)	2-5/8 L x 1-3/4 W (67 L x 44 W)	Zinc	(2) #8 x 1-1/4 in. Sheet Metal Screw (1) Mounting Bracket	N/A
BH36010G10	Robe Hook	Brushed Nickel	Single	2-5/8 (67)	1-3/4 (44)	2-1/2 (64)	2-5/8 L x 1-3/4 W (67 L x 44 W)	Zinc	(2) #8 x 1-1/4 in. Sheet Metal Screw (1) Mounting Bracket	N/A
BH36010MB	Robe Hook	Matte Black	Single	2-5/8 (67)	1-3/4 (44)	2-1/2 (64)	2-5/8 L x 1-3/4 W (67 L x 44 W)	Zinc	(2) #8 x 1-1/4 in. Sheet Metal Screw (1) Mounting Bracket	N/A
BH36010ORB	Robe Hook	Oil-Rubbed Bronze	Single	2-5/8 (67)	1-3/4 (44)	2-1/2 (64)	2-5/8 L x 1-3/4 W (67 L x 44 W)	Zinc	(2) #8 x 1-1/4 in. Sheet Metal Screw (1) Mounting Bracket	N/A
BP5531126	Knob	Polished Chrome	1-3/8 (35) LGTH	1-3/8 (35)	11/16 (17)	1-1/8 (29)	3/4 L x 3/4 W (19 L x 19 W)	Zinc	(1) #8-32 x 1in Truss Head Machine Screw (1) #8-32 x 1-1/2in Truss Head Machine Screw	N/A
BP55311AP	Knob	Aged Pewter	1-3/8 (35) LGTH	1-3/8 (35)	11/16 (17)	1-1/8 (29)	3/4 L x 3/4 W (19 L x 19 W)	Zinc	(1) #8-32 x 1in Truss Head Machine Screw (1) #8-32 x 1-1/2in Truss Head Machine Screw	N/A
BP55311BBR	Knob	Black Bronze	1-3/8 (35) LGTH	1-3/8 (35)	11/16 (17)	1-1/8 (29)	3/4 L x 3/4 W (19 L x 19 W)	Zinc	(1) #8-32 x 1in Truss Head Machine Screw (1) #8-32 x 1-1/2in Truss Head Machine Screw	N/A
BP55311BBZ	Knob	Golden Champagne	1-3/8 (35) LGTH	1-3/8 (35)	11/16 (17)	1-1/8 (29)	3/4 L x 3/4 W (19 L x 19 W)	Zinc	(1) #8-32 x 1in Truss Head Machine Screw (1) #8-32 x 1-1/2in Truss Head Machine Screw	N/A
BP55311CZ	Knob	Champagne Bronze	1-3/8 (35) LGTH	1-3/8 (35)	11/16 (17)	1-1/8 (29)	3/4 L x 3/4 W (19 L x 19 W)	Zinc	(1) #8-32 x 1in Truss Head Machine Screw (1) #8-32 x 1-1/2in Truss Head Machine Screw	N/A
BP55311DOB	Knob	Dark Oiled Bronze	1-3/8 (35) LGTH	1-3/8 (35)	11/16 (17)	1-1/8 (29)	3/4 L x 3/4 W (19 L x 19 W)	Zinc	(1) #8-32 x 1in Truss Head Machine Screw (1) #8-32 x 1-1/2in Truss Head Machine Screw	N/A
BP55311G10	Knob	Satin Nickel	1-3/8 (35) LGTH	1-3/8 (35)	11/16 (17)	1-1/8 (29)	3/4 L x 3/4 W (19 L x 19 W)	Zinc	(1) #8-32 x 1in Truss Head Machine Screw (1) #8-32 x 1-1/2in Truss Head Machine Screw	N/A
BP55311PN	Knob	Polished Nickel	1-3/8 (35) LGTH	1-3/8 (35)	11/16 (17)	1-1/8 (29)	3/4 L x 3/4 W (19 L x 19 W)	Zinc	(1) #8-32 x 1in Truss Head Machine Screw (1) #8-32 x 1-1/2in Truss Head Machine Screw	N/A

Mounting hardware included.  
The dimensional information provided here should be verified with the actual product prior to drilling or attempting to install the hardware.  
Please direct any questions you may have on the installation process to Amerock Customer Service (see back cover for contact information).

# PRODUCT INDEX

Product No.	Type	Finish	Product Detail in (mm)	Length in (mm)	Width in (mm)	Projection in (mm)	Base Dimensions in (mm)	Base Material	Mounting Hardware Included	ADA-Friendly
<b>Highland Ridge (continued) • p. 32</b>										
BP5531226	Knob	Polished Chrome	1-3/16 (30) DIA	1-3/16 (30)	N/A	1-3/16 (30)	11/16 L x 11/16 W (17 L x 17 W)	Zinc	(1) #8-32 x 1in Truss Head Machine Screw (1) #8-32 x 1-1/2in Truss Head Machine Screw	N/A
BP55312AP	Knob	Aged Pewter	1-3/16 (30) DIA	1-3/16 (30)	N/A	1-3/16 (30)	11/16 L x 11/16 W (17 L x 17 W)	Zinc	(1) #8-32 x 1in Truss Head Machine Screw (1) #8-32 x 1-1/2in Truss Head Machine Screw	N/A
BP55312BBR	Knob	Black Bronze	1-3/16 (30) DIA	1-3/16 (30)	N/A	1-3/16 (30)	11/16 L x 11/16 W (17 L x 17 W)	Zinc	(1) #8-32 x 1in Truss Head Machine Screw (1) #8-32 x 1-1/2in Truss Head Machine Screw	N/A
BP55312BBZ	Knob	Golden Champagne	1-3/16 (30) DIA	1-3/16 (30)	N/A	1-3/16 (30)	11/16 L x 11/16 W (17 L x 17 W)	Zinc	(1) #8-32 x 1in Truss Head Machine Screw (1) #8-32 x 1-1/2in Truss Head Machine Screw	N/A
BP55312CZ	Knob	Champagne Bronze	1-3/16 (30) DIA	1-3/16 (30)	N/A	1-3/16 (30)	11/16 L x 11/16 W (17 L x 17 W)	Zinc	(1) #8-32 x 1in Truss Head Machine Screw (1) #8-32 x 1-1/2in Truss Head Machine Screw	N/A
BP55312DOB	Knob	Dark Oiled Bronze	1-3/16 (30) DIA	1-3/16 (30)	N/A	1-3/16 (30)	11/16 L x 11/16 W (17 L x 17 W)	Zinc	(1) #8-32 x 1in Truss Head Machine Screw (1) #8-32 x 1-1/2in Truss Head Machine Screw	N/A
BP55312G10	Knob	Satin Nickel	1-3/16 (30) DIA	1-3/16 (30)	N/A	1-3/16 (30)	11/16 L x 11/16 W (17 L x 17 W)	Zinc	(1) #8-32 x 1in Truss Head Machine Screw (1) #8-32 x 1-1/2in Truss Head Machine Screw	N/A
BP55312PN	Knob	Polished Nickel	1-3/16 (30) DIA	1-3/16 (30)	N/A	1-3/16 (30)	11/16 L x 11/16 W (17 L x 17 W)	Zinc	(1) #8-32 x 1in Truss Head Machine Screw (1) #8-32 x 1-1/2in Truss Head Machine Screw	N/A
BP55315AP	Latch	Aged Pewter	1-7/8 (48) LGTH	1-7/8 (48)	1-3/4 (44)	1-3/16 (30)	1-5/16 L: 7/16 R L x 1-3/4 W (33 L: 11 R L x 44 W)	Zinc	(6) #6 x 1/2 in. Oval Head Wood Screw	N/A
BP55315DOB	Latch	Dark Oiled Bronze	1-7/8 (48) LGTH	1-7/8 (48)	1-3/4 (44)	1-3/16 (30)	1-5/16 L: 7/16 R L x 1-3/4 W (33 L: 11 R L x 44 W)	Zinc	(6) #6 x 1/2 in. Oval Head Wood Screw	N/A
BP55315PN	Latch	Polished Nickel	1-7/8 (48) LGTH	1-7/8 (48)	1-3/4 (44)	1-3/16 (30)	1-5/16 L: 7/16 R L x 1-3/4 W (33 L: 11 R L x 44 W)	Zinc	(6) #6 x 1/2 in. Oval Head Wood Screw	N/A
BP5531626	Pull	Polished Chrome	3 (76) CTC	4-5/16 (110)	1/2 (13)	1-1/16 (27)	13/16 L x 7/16 W (21 L x 11 W)	Zinc	(2) #8-32 x 1in Truss Head Machine Screw (2) #8-32 x 1-1/2in Truss Head Machine Screw	N/A
BP55316AP	Pull	Aged Pewter	3 (76) CTC	4-5/16 (110)	1/2 (13)	1-1/16 (27)	13/16 L x 7/16 W (21 L x 11 W)	Zinc	(2) #8-32 x 1in Truss Head Machine Screw (2) #8-32 x 1-1/2in Truss Head Machine Screw	N/A
BP55316BBR	Pull	Black Bronze	3 (76) CTC	4-5/16 (110)	1/2 (13)	1-1/16 (27)	13/16 L x 7/16 W (21 L x 11 W)	Zinc	(2) #8-32 x 1in Truss Head Machine Screw (2) #8-32 x 1-1/2in Truss Head Machine Screw	N/A
BP55316BBZ	Pull	Golden Champagne	3 (76) CTC	4-5/16 (110)	1/2 (13)	1-1/16 (27)	13/16 L x 7/16 W (21 L x 11 W)	Zinc	(2) #8-32 x 1in Truss Head Machine Screw (2) #8-32 x 1-1/2in Truss Head Machine Screw	N/A
BP55316CBZ	Pull	Caramel Bronze	3 (76) CTC	4-5/16 (110)	1/2 (13)	1-1/16 (27)	13/16 L x 7/16 W (21 L x 11 W)	Zinc	(2) #8-32 x 1in Truss Head Machine Screw (2) #8-32 x 1-1/2in Truss Head Machine Screw	N/A
BP55316CZ	Pull	Champagne Bronze	3 (76) CTC	4-5/16 (110)	1/2 (13)	1-1/16 (27)	13/16 L x 7/16 W (21 L x 11 W)	Zinc	(2) #8-32 x 1in Truss Head Machine Screw (2) #8-32 x 1-1/2in Truss Head Machine Screw	N/A
BP55316DOB	Pull	Dark Oiled Bronze	3 (76) CTC	4-5/16 (110)	1/2 (13)	1-1/16 (27)	13/16 L x 7/16 W (21 L x 11 W)	Zinc	(2) #8-32 x 1in Truss Head Machine Screw (2) #8-32 x 1-1/2in Truss Head Machine Screw	N/A
BP55316G10	Pull	Satin Nickel	3 (76) CTC	4-5/16 (110)	1/2 (13)	1-1/16 (27)	13/16 L x 7/16 W (21 L x 11 W)	Zinc	(2) #8-32 x 1in Truss Head Machine Screw (2) #8-32 x 1-1/2in Truss Head Machine Screw	N/A
BP55316PN	Pull	Polished Nickel	3 (76) CTC	4-5/16 (110)	1/2 (13)	1-1/16 (27)	13/16 L x 7/16 W (21 L x 11 W)	Zinc	(2) #8-32 x 1in Truss Head Machine Screw (2) #8-32 x 1-1/2in Truss Head Machine Screw	N/A
BP5531726	Pull	Polished Chrome	3-3/4 (96) CTC	5-3/16 (132)	9/16 (14)	1-1/8 (29)	1 L x 9/16 W (25 L x 14 W)	Zinc	(2) #8-32 x 1in Truss Head Machine Screw (2) #8-32 x 1-1/2in Truss Head Machine Screw	✓
BP55317AP	Pull	Aged Pewter	3-3/4 (96) CTC	5-3/16 (132)	9/16 (14)	1-1/8 (29)	1 L x 9/16 W (25 L x 14 W)	Zinc	(2) #8-32 x 1in Truss Head Machine Screw (2) #8-32 x 1-1/2in Truss Head Machine Screw	✓
BP55317BBR	Pull	Black Bronze	3-3/4 (96) CTC	5-3/16 (132)	9/16 (14)	1-1/8 (29)	1 L x 9/16 W (25 L x 14 W)	Zinc	(2) #8-32 x 1in Truss Head Machine Screw (2) #8-32 x 1-1/2in Truss Head Machine Screw	✓
BP55317BBZ	Pull	Golden Champagne	3-3/4 (96) CTC	5-3/16 (132)	9/16 (14)	1-1/8 (29)	1 L x 9/16 W (25 L x 14 W)	Zinc	(2) #8-32 x 1in Truss Head Machine Screw (2) #8-32 x 1-1/2in Truss Head Machine Screw	✓
BP55317CZ	Pull	Champagne Bronze	3-3/4 (96) CTC	5-3/16 (132)	9/16 (14)	1-1/8 (29)	1 L x 9/16 W (25 L x 14 W)	Zinc	(2) #8-32 x 1in Truss Head Machine Screw (2) #8-32 x 1-1/2in Truss Head Machine Screw	✓

Mounting hardware included.

The dimensional information provided here should be verified with the actual product prior to drilling or attempting to install the hardware. Please direct any questions you may have on the installation process to Amerock Customer Service (see back cover for contact information).



# PRODUCT INDEX

Product No.	Type	Finish	Product Detail in (mm)	Length in (mm)	Width in (mm)	Projection in (mm)	Base Dimensions in (mm)	Base Material	Mounting Hardware Included	ADA-Friendly
<b>Highland Ridge (continued) • p. 32</b>										
BP55317DOB	Pull	Dark Oiled Bronze	3-3/4 (96) CTC	5-3/16 (132)	9/16 (14)	1-1/8 (29)	1 L x 9/16 W (25 L x 14 W)	Zinc	(2) #8-32 x 1in Truss Head Machine Screw (2) #8-32 x 1-1/2in Truss Head Machine Screw	✓
BP55317G10	Pull	Satin Nickel	3-3/4 (96) CTC	5-3/16 (132)	9/16 (14)	1-1/8 (29)	1 L x 9/16 W (25 L x 14 W)	Zinc	(2) #8-32 x 1in Truss Head Machine Screw (2) #8-32 x 1-1/2in Truss Head Machine Screw	✓
BP55317PN	Pull	Polished Nickel	3-3/4 (96) CTC	5-3/16 (132)	9/16 (14)	1-1/8 (29)	1 L x 9/16 W (25 L x 14 W)	Zinc	(2) #8-32 x 1in Truss Head Machine Screw (2) #8-32 x 1-1/2in Truss Head Machine Screw	✓
BP5531826	Cup Pull	Polished Chrome	3-1/2 (89) CTC	4 (102)	1-1/8 (29)	3/4 (19)	4 L x 1-1/8 W (102 L x 29 W)	Zinc	(4) #6 x 1/2 in. Oval Head Wood Screw	N/A
BP55318AP	Cup Pull	Aged Pewter	3-1/2 (89) CTC	4 (102)	1-1/8 (29)	3/4 (19)	4 L x 1-1/8 W (102 L x 29 W)	Zinc	(4) #6 x 1/2 in. Oval Head Wood Screw	N/A
BP55318BBR	Cup Pull	Black Bronze	3-1/2 (89) CTC	4 (102)	1-1/8 (29)	3/4 (19)	4 L x 1-1/8 W (102 L x 29 W)	Zinc	(4) #6 x 1/2 in. Oval Head Wood Screw	N/A
BP55318BBZ	Cup Pull	Golden Champagne	3-1/2 (89) CTC	4 (102)	1-1/8 (29)	3/4 (19)	4 L x 1-1/8 W (102 L x 29 W)	Zinc	(4) #6 x 1/2 in. Oval Head Wood Screw	N/A
BP55318CZ	Cup Pull	Champagne Bronze	3-1/2 (89) CTC	4 (102)	1-1/8 (29)	3/4 (19)	4 L x 1-1/8 W (102 L x 29 W)	Zinc	(4) #6 x 1/2 in. Oval Head Wood Screw	N/A
BP55318DOB	Cup Pull	Dark Oiled Bronze	3-1/2 (89) CTC	4 (102)	1-1/8 (29)	3/4 (19)	4 L x 1-1/8 W (102 L x 29 W)	Zinc	(4) #6 x 1/2 in. Oval Head Wood Screw	N/A
BP55318G10	Cup Pull	Satin Nickel	3-1/2 (89) CTC	4 (102)	1-1/8 (29)	3/4 (19)	4 L x 1-1/8 W (102 L x 29 W)	Zinc	(4) #6 x 1/2 in. Oval Head Wood Screw	N/A
BP55318PN	Cup Pull	Polished Nickel	3-1/2 (89) CTC	4 (102)	1-1/8 (29)	3/4 (19)	4 L x 1-1/8 W (102 L x 29 W)	Zinc	(4) #6 x 1/2 in. Oval Head Wood Screw	N/A
BP5531926	Pull	Polished Chrome	5-1/16 (128) CTC	6-5/8 (168)	5/8 (16)	1-1/4 (32)	1-1/4 L x 5/8 W (32 L x 16 W)	Zinc	(2) #8-32 x 1in Truss Head Machine Screw (2) #8-32 x 1-1/2in Truss Head Machine Screw	✓
BP55319AP	Pull	Aged Pewter	5-1/16 (128) CTC	6-5/8 (168)	5/8 (16)	1-1/4 (32)	1-1/4 L x 5/8 W (32 L x 16 W)	Zinc	(2) #8-32 x 1in Truss Head Machine Screw (2) #8-32 x 1-1/2in Truss Head Machine Screw	✓
BP55319BBR	Pull	Black Bronze	5-1/16 (128) CTC	6-5/8 (168)	5/8 (16)	1-1/4 (32)	1-1/4 L x 5/8 W (32 L x 16 W)	Zinc	(2) #8-32 x 1in Truss Head Machine Screw (2) #8-32 x 1-1/2in Truss Head Machine Screw	✓
BP55319BBZ	Pull	Golden Champagne	5-1/16 (128) CTC	6-5/8 (168)	5/8 (16)	1-1/4 (32)	1-1/4 L x 5/8 W (32 L x 16 W)	Zinc	(2) #8-32 x 1in Truss Head Machine Screw (2) #8-32 x 1-1/2in Truss Head Machine Screw	✓
BP55319CZ	Pull	Champagne Bronze	5-1/16 (128) CTC	6-5/8 (168)	5/8 (16)	1-1/4 (32)	1-1/4 L x 5/8 W (32 L x 16 W)	Zinc	(2) #8-32 x 1in Truss Head Machine Screw (2) #8-32 x 1-1/2in Truss Head Machine Screw	✓
BP55319DOB	Pull	Dark Oiled Bronze	5-1/16 (128) CTC	6-5/8 (168)	5/8 (16)	1-1/4 (32)	1-1/4 L x 5/8 W (32 L x 16 W)	Zinc	(2) #8-32 x 1in Truss Head Machine Screw (2) #8-32 x 1-1/2in Truss Head Machine Screw	✓
BP55319G10	Pull	Satin Nickel	5-1/16 (128) CTC	6-5/8 (168)	5/8 (16)	1-1/4 (32)	1-1/4 L x 5/8 W (32 L x 16 W)	Zinc	(2) #8-32 x 1in Truss Head Machine Screw (2) #8-32 x 1-1/2in Truss Head Machine Screw	✓
BP55319PN	Pull	Polished Nickel	5-1/16 (128) CTC	6-5/8 (168)	5/8 (16)	1-1/4 (32)	1-1/4 L x 5/8 W (32 L x 16 W)	Zinc	(2) #8-32 x 1in Truss Head Machine Screw (2) #8-32 x 1-1/2in Truss Head Machine Screw	✓
BP5532126	Pull	Polished Chrome	6-5/16 (160) CTC	8-9/16 (217)	11/16 (17)	1-5/16 (33)	1-5/8 L x 5/8 W (41 L x 16 W)	Zinc	(2) #8-32 x 1in Truss Head Machine Screw (2) #8-32 x 1-1/2in Truss Head Machine Screw	✓
BP55321AP	Pull	Aged Pewter	6-5/16 (160) CTC	8-9/16 (217)	11/16 (17)	1-5/16 (33)	1-5/8 L x 5/8 W (41 L x 16 W)	Zinc	(2) #8-32 x 1in Truss Head Machine Screw (2) #8-32 x 1-1/2in Truss Head Machine Screw	✓
BP55321BBR	Pull	Black Bronze	6-5/16 (160) CTC	8-9/16 (217)	11/16 (17)	1-5/16 (33)	1-5/8 L x 5/8 W (41 L x 16 W)	Zinc	(2) #8-32 x 1in Truss Head Machine Screw (2) #8-32 x 1-1/2in Truss Head Machine Screw	✓
BP55321BBZ	Pull	Golden Champagne	6-5/16 (160) CTC	8-9/16 (217)	11/16 (17)	1-5/16 (33)	1-5/8 L x 5/8 W (41 L x 16 W)	Zinc	(2) #8-32 x 1in Truss Head Machine Screw (2) #8-32 x 1-1/2in Truss Head Machine Screw	✓
BP55321CZ	Pull	Champagne Bronze	6-5/16 (160) CTC	8-9/16 (217)	11/16 (17)	1-5/16 (33)	1-5/8 L x 5/8 W (41 L x 16 W)	Zinc	(2) #8-32 x 1in Truss Head Machine Screw (2) #8-32 x 1-1/2in Truss Head Machine Screw	✓
BP55321DOB	Pull	Dark Oiled Bronze	6-5/16 (160) CTC	8-9/16 (217)	11/16 (17)	1-5/16 (33)	1-5/8 L x 5/8 W (41 L x 16 W)	Zinc	(2) #8-32 x 1in Truss Head Machine Screw (2) #8-32 x 1-1/2in Truss Head Machine Screw	✓

Mounting hardware included.  
The dimensional information provided here should be verified with the actual product prior to drilling or attempting to install the hardware.  
Please direct any questions you may have on the installation process to Amerock Customer Service (see back cover for contact information).

# PRODUCT INDEX

Product No.	Type	Finish	Product Detail in (mm)	Length in (mm)	Width in (mm)	Projection in (mm)	Base Dimensions in (mm)	Base Material	Mounting Hardware Included	ADA-Friendly
<b>Highland Ridge (continued) • p. 32</b>										
BP55321G10	Pull	Satin Nickel	6-5/16 (160) CTC	8-9/16 (217)	11/16 (17)	1-5/16 (33)	1-5/8 L x 5/8 W (41 L x 16 W)	Zinc	(2) #8-32 x 1in Truss Head Machine Screw (2) #8-32 x 1-1/2in Truss Head Machine Screw	✓
BP55321PN	Pull	Polished Nickel	6-5/16 (160) CTC	8-9/16 (217)	11/16 (17)	1-5/16 (33)	1-5/8 L x 5/8 W (41 L x 16 W)	Zinc	(2) #8-32 x 1in Truss Head Machine Screw (2) #8-32 x 1-1/2in Truss Head Machine Screw	✓
BP55322AP	Appliance Pull	Aged Pewter	8 (203) CTC	10-7/16 (265)	7/8 (22)	1-5/8 (41)	1-15/16 L x 13/16 W (49 L x 21 W)	Zinc	(2) #10-24 x 3/4in Pan Head Machine Screw (2) #10-24 x 1in Pan Head Machine Screw (2) #10-24 x 1-1/4in Pan Head Machine Screw (2) #10-24 x 1-1/2in Pan Head Machine Screw (2) #10-24 x 1-3/4in Pan Head Machine Screw	✓
BP55322BBR	Appliance Pull	Black Bronze	8 (203) CTC	10-7/16 (265)	7/8 (22)	1-5/8 (41)	1-15/16 L x 13/16 W (49 L x 21 W)	Zinc	(2) #10-24 x 3/4in Pan Head Machine Screw (2) #10-24 x 1in Pan Head Machine Screw (2) #10-24 x 1-1/4in Pan Head Machine Screw (2) #10-24 x 1-1/2in Pan Head Machine Screw (2) #10-24 x 1-3/4in Pan Head Machine Screw	✓
BP55322BBZ	Appliance Pull	Golden Champagne	8 (203) CTC	10-7/16 (265)	7/8 (22)	1-5/8 (41)	1-15/16 L x 13/16 W (49 L x 21 W)	Zinc	(2) #10-24 x 3/4in Pan Head Machine Screw (2) #10-24 x 1in Pan Head Machine Screw (2) #10-24 x 1-1/4in Pan Head Machine Screw (2) #10-24 x 1-1/2in Pan Head Machine Screw (2) #10-24 x 1-3/4in Pan Head Machine Screw	✓
BP55322DOB	Appliance Pull	Dark Oiled Bronze	8 (203) CTC	10-7/16 (265)	7/8 (22)	1-5/8 (41)	1-15/16 L x 13/16 W (49 L x 21 W)	Zinc	(2) #10-24 x 3/4in Pan Head Machine Screw (2) #10-24 x 1in Pan Head Machine Screw (2) #10-24 x 1-1/4in Pan Head Machine Screw (2) #10-24 x 1-1/2in Pan Head Machine Screw (2) #10-24 x 1-3/4in Pan Head Machine Screw	✓
BP55322G10	Appliance Pull	Satin Nickel	8 (203) CTC	10-7/16 (265)	7/8 (22)	1-5/8 (41)	1-15/16 L x 13/16 W (49 L x 21 W)	Zinc	(2) #10-24 x 3/4in Pan Head Machine Screw (2) #10-24 x 1in Pan Head Machine Screw (2) #10-24 x 1-1/4in Pan Head Machine Screw (2) #10-24 x 1-1/2in Pan Head Machine Screw (2) #10-24 x 1-3/4in Pan Head Machine Screw	✓
BP55322PN	Appliance Pull	Polished Nickel	8 (203) CTC	10-7/16 (265)	7/8 (22)	1-5/8 (41)	1-15/16 L x 13/16 W (49 L x 21 W)	Zinc	(2) #10-24 x 3/4in Pan Head Machine Screw (2) #10-24 x 1in Pan Head Machine Screw (2) #10-24 x 1-1/4in Pan Head Machine Screw (2) #10-24 x 1-1/2in Pan Head Machine Screw (2) #10-24 x 1-3/4in Pan Head Machine Screw	✓
BP55323AP	Appliance Pull	Aged Pewter	12 (305) CTC	15-5/16 (389)	1 (25)	1-13/16 (46)	2-7/16 L x 1 W (62 L x 25 W)	Zinc	(2) #10-24 x 3/4in Pan Head Machine Screw (2) #10-24 x 1in Pan Head Machine Screw (2) #10-24 x 1-1/4in Pan Head Machine Screw (2) #10-24 x 1-1/2in Pan Head Machine Screw (2) #10-24 x 1-3/4in Pan Head Machine Screw	✓
BP55323BBR	Appliance Pull	Black Bronze	12 (305) CTC	15-5/16 (389)	1 (25)	1-13/16 (46)	2-7/16 L x 1 W (62 L x 25 W)	Zinc	(2) #10-24 x 3/4in Pan Head Machine Screw (2) #10-24 x 1in Pan Head Machine Screw (2) #10-24 x 1-1/4in Pan Head Machine Screw (2) #10-24 x 1-1/2in Pan Head Machine Screw (2) #10-24 x 1-3/4in Pan Head Machine Screw	✓
BP55323BBZ	Appliance Pull	Golden Champagne	12 (305) CTC	15-5/16 (389)	1 (25)	1-13/16 (46)	2-7/16 L x 1 W (62 L x 25 W)	Zinc	(2) #10-24 x 3/4in Pan Head Machine Screw (2) #10-24 x 1in Pan Head Machine Screw (2) #10-24 x 1-1/4in Pan Head Machine Screw (2) #10-24 x 1-1/2in Pan Head Machine Screw (2) #10-24 x 1-3/4in Pan Head Machine Screw	✓
BP55323DOB	Appliance Pull	Dark Oiled Bronze	12 (305) CTC	15-5/16 (389)	1 (25)	1-13/16 (46)	2-7/16 L x 1 W (62 L x 25 W)	Zinc	(2) #10-24 x 3/4in Pan Head Machine Screw (2) #10-24 x 1in Pan Head Machine Screw (2) #10-24 x 1-1/4in Pan Head Machine Screw (2) #10-24 x 1-1/2in Pan Head Machine Screw (2) #10-24 x 1-3/4in Pan Head Machine Screw	✓

Mounting hardware included.  
The dimensional information provided here should be verified with the actual product prior to drilling or attempting to install the hardware.  
Please direct any questions you may have on the installation process to Amerock Customer Service (see back cover for contact information).

# PRODUCT INDEX

Product No.	Type	Finish	Product Detail in (mm)	Length in (mm)	Width in (mm)	Projection in (mm)	Base Dimensions in (mm)	Base Material	Mounting Hardware Included	ADA-Friendly
<b>Highland Ridge (continued) • p. 32</b>										
BP55323G10	Appliance Pull	Satin Nickel	12 (305) CTC	15-5/16 (389)	1 (25)	1-13/16 (46)	2-7/16 L x 1 W (62 L x 25 W)	Zinc	(2) #10-24 x 3/4in Pan Head Machine Screw (2) #10-24 x 1in Pan Head Machine Screw (2) #10-24 x 1-1/4in Pan Head Machine Screw (2) #10-24 x 1-1/2in Pan Head Machine Screw (2) #10-24 x 1-3/4in Pan Head Machine Screw	✓
BP55323PN	Appliance Pull	Polished Nickel	12 (305) CTC	15-5/16 (389)	1 (25)	1-13/16 (46)	2-7/16 L x 1 W (62 L x 25 W)	Zinc	(2) #10-24 x 3/4in Pan Head Machine Screw (2) #10-24 x 1in Pan Head Machine Screw (2) #10-24 x 1-1/4in Pan Head Machine Screw (2) #10-24 x 1-1/2in Pan Head Machine Screw (2) #10-24 x 1-3/4in Pan Head Machine Screw	✓
BP55324AP	Appliance Pull	Aged Pewter	18 (457) CTC	20-7/8 (530)	1-1/16 (27)	1-15/16 (49)	2-3/8 L x 1-1/16 W (60 L x 27 W)	Zinc	(2) #10-24 x 3/4in Pan Head Machine Screw (2) #10-24 x 1in Pan Head Machine Screw (2) #10-24 x 1-1/4in Pan Head Machine Screw (2) #10-24 x 1-1/2in Pan Head Machine Screw (2) #10-24 x 1-3/4in Pan Head Machine Screw	✓
BP55324BBR	Appliance Pull	Black Bronze	18 (457) CTC	20-7/8 (530)	1-1/16 (27)	1-15/16 (49)	2-3/8 L x 1-1/16 W (60 L x 27 W)	Zinc	(2) #10-24 x 3/4in Pan Head Machine Screw (2) #10-24 x 1in Pan Head Machine Screw (2) #10-24 x 1-1/4in Pan Head Machine Screw (2) #10-24 x 1-1/2in Pan Head Machine Screw (2) #10-24 x 1-3/4in Pan Head Machine Screw	✓
BP55324BBZ	Appliance Pull	Golden Champagne	18 (457) CTC	20-7/8 (530)	1-1/16 (27)	1-15/16 (49)	2-3/8 L x 1-1/16 W (60 L x 27 W)	Zinc	(2) #10-24 x 3/4in Pan Head Machine Screw (2) #10-24 x 1in Pan Head Machine Screw (2) #10-24 x 1-1/4in Pan Head Machine Screw (2) #10-24 x 1-1/2in Pan Head Machine Screw (2) #10-24 x 1-3/4in Pan Head Machine Screw	✓
BP55324DOB	Appliance Pull	Dark Oiled Bronze	18 (457) CTC	20-7/8 (530)	1-1/16 (27)	1-15/16 (49)	2-3/8 L x 1-1/16 W (60 L x 27 W)	Zinc	(2) #10-24 x 3/4in Pan Head Machine Screw (2) #10-24 x 1in Pan Head Machine Screw (2) #10-24 x 1-1/4in Pan Head Machine Screw (2) #10-24 x 1-1/2in Pan Head Machine Screw (2) #10-24 x 1-3/4in Pan Head Machine Screw	✓
BP55324G10	Appliance Pull	Satin Nickel	18 (457) CTC	20-7/8 (530)	1-1/16 (27)	1-15/16 (49)	2-3/8 L x 1-1/16 W (60 L x 27 W)	Zinc	(2) #10-24 x 3/4in Pan Head Machine Screw (2) #10-24 x 1in Pan Head Machine Screw (2) #10-24 x 1-1/4in Pan Head Machine Screw (2) #10-24 x 1-1/2in Pan Head Machine Screw (2) #10-24 x 1-3/4in Pan Head Machine Screw	✓
BP55324PN	Appliance Pull	Polished Nickel	18 (457) CTC	20-7/8 (530)	1-1/16 (27)	1-15/16 (49)	2-3/8 L x 1-1/16 W (60 L x 27 W)	Zinc	(2) #10-24 x 3/4in Pan Head Machine Screw (2) #10-24 x 1in Pan Head Machine Screw (2) #10-24 x 1-1/4in Pan Head Machine Screw (2) #10-24 x 1-1/2in Pan Head Machine Screw (2) #10-24 x 1-3/4in Pan Head Machine Screw	✓
<b>Overton • p. 34</b>										
BP36680BCRBGL	Knob	Black Chrome/ Brushed Gold	1-3/8 (35) LGTH	1-3/8 (35)	1-5/16 (33)	1-1/16 (27)	9/16 L x 11/16 W (14 L x 17 W)	Zinc/ Aluminum	(1) M4 X 1 in Truss Head Machine Screw (1) M4 X 1-9/16 in Truss Head Machine Screw	N/A
BP36680BGLBCR	Knob	Brushed Gold/ Black Chrome	1-3/8 (35) LGTH	1-3/8 (35)	1-5/16 (33)	1-1/16 (27)	9/16 L x 11/16 W (14 L x 17 W)	Zinc/ Aluminum	(1) M4 X 1 in Truss Head Machine Screw (1) M4 X 1-9/16 in Truss Head Machine Screw	N/A
BP36680BGLG10	Knob	Brushed Gold/ Satin Nickel	1-3/8 (35) LGTH	1-3/8 (35)	1-5/16 (33)	1-1/16 (27)	9/16 L x 11/16 W (14 L x 17 W)	Zinc/ Aluminum	(1) M4 X 1 in Truss Head Machine Screw (1) M4 X 1-9/16 in Truss Head Machine Screw	N/A
BP36680BMBBGL	Knob	Brushed Matte Black/ Brushed Gold	1-3/8 (35) LGTH	1-3/8 (35)	1-5/16 (33)	1-1/16 (27)	9/16 L x 11/16 W (14 L x 17 W)	Zinc/ Aluminum	(1) M4 X 1 in Truss Head Machine Screw (1) M4 X 1-9/16 in Truss Head Machine Screw	N/A
BP36680BMBG10	Knob	Brushed Matte Black/ Satin Nickel	1-3/8 (35) LGTH	1-3/8 (35)	1-5/16 (33)	1-1/16 (27)	9/16 L x 11/16 W (14 L x 17 W)	Zinc/ Aluminum	(1) M4 X 1 in Truss Head Machine Screw & (1) M4 X 1-9/16 in Truss Head Machine Screw	N/A

Mounting hardware included.  
The dimensional information provided here should be verified with the actual product prior to drilling or attempting to install the hardware.  
Please direct any questions you may have on the installation process to Amerock Customer Service (see back cover for contact information).

# PRODUCT INDEX

Product No.	Type	Finish	Product Detail in (mm)	Length in (mm)	Width in (mm)	Projection in (mm)	Base Dimensions in (mm)	Base Material	Mounting Hardware Included	ADA-Friendly
Overton (continued) • p. 34										
BP36680G1026	Knob	Satin Nickel/ Polished Chrome	1-3/8 (35) LGTH	1-3/8 (35)	1-5/16 (33)	1-1/16 (27)	9/16 L x 11/16 W (14 L x 17 W)	Zinc/ Aluminum	(1) M4 X 1 in Truss Head Machine Screw (1) M4 X 1-9/16 in Truss Head Machine Screw	N/A
BP36681BCRBGL	Pull	Black Chrome/ Brushed Gold	3-3/4 (96) CTC	4-15/16 (125)	11/16 (17)	1-1/8 (29)	1/2 L x 11/16 W (13 L x 17 W)	Zinc/ Aluminum	(2) M4 X 1 in Truss Head Machine Screw (2) M4 X 1-9/16 in Truss Head Machine Screw	N/A
BP36681BGLBCR	Pull	Brushed Gold/ Black Chrome	3-3/4 (96) CTC	4-15/16 (125)	11/16 (17)	1-1/8 (29)	1/2 L x 11/16 W (13 L x 17 W)	Zinc/ Aluminum	(2) M4 X 1 in Truss Head Machine Screw (2) M4 X 1-9/16 in Truss Head Machine Screw	N/A
BP36681BGLG10	Pull	Brushed Gold/ Satin Nickel	3-3/4 (96) CTC	4-15/16 (125)	11/16 (17)	1-1/8 (29)	1/2 L x 11/16 W (13 L x 17 W)	Zinc/ Aluminum	(2) M4 X 1 in Truss Head Machine Screw (2) M4 X 1-9/16 in Truss Head Machine Screw	N/A
BP36681BMBBGL	Pull	Brushed Matte Black/ Brushed Gold	3-3/4 (96) CTC	4-15/16 (125)	11/16 (17)	1-1/8 (29)	1/2 L x 11/16 W (13 L x 17 W)	Zinc/ Aluminum	(2) M4 X 1 in Truss Head Machine Screw (2) M4 X 1-9/16 in Truss Head Machine Screw	N/A
BP36681BMBG10	Pull	Brushed Matte Black/ Satin Nickel	3-3/4 (96) CTC	4-15/16 (125)	11/16 (17)	1-1/8 (29)	1/2 L x 11/16 W (13 L x 17 W)	Zinc/ Aluminum	(2) M4 X 1 in Truss Head Machine Screw (2) M4 X 1-9/16 in Truss Head Machine Screw	N/A
BP36681G1026	Pull	Satin Nickel/ Polished Chrome	3-3/4 (96) CTC	4-15/16 (125)	11/16 (17)	1-1/8 (29)	1/2 L x 11/16 W (13 L x 17 W)	Zinc/ Aluminum	(2) M4 X 1 in Truss Head Machine Screw (2) M4 X 1-9/16 in Truss Head Machine Screw	N/A
BP36682BCRBGL	Pull	Black Chrome/ Brushed Gold	5-1/16 (128) CTC	6-3/16 (157)	11/16 (17)	1-1/8 (29)	1/2 L x 11/16 W (13 L x 17 W)	Zinc/ Aluminum	(2) M4 X 1 in Truss Head Machine Screw (2) M4 X 1-9/16 in Truss Head Machine Screw	N/A
BP36682BGLBCR	Pull	Brushed Gold/ Black Chrome	5-1/16 (128) CTC	6-3/16 (157)	11/16 (17)	1-1/8 (29)	1/2 L x 11/16 W (13 L x 17 W)	Zinc/ Aluminum	(2) M4 X 1 in Truss Head Machine Screw (2) M4 X 1-9/16 in Truss Head Machine Screw	N/A
BP36682BGLG10	Pull	Brushed Gold/ Satin Nickel	5-1/16 (128) CTC	6-3/16 (157)	11/16 (17)	1-1/8 (29)	1/2 L x 11/16 W (13 L x 17 W)	Zinc/ Aluminum	(2) M4 X 1 in Truss Head Machine Screw (2) M4 X 1-9/16 in Truss Head Machine Screw	N/A
BP36682BMBBGL	Pull	Brushed Matte Black/ Brushed Gold	5-1/16 (128) CTC	6-3/16 (157)	11/16 (17)	1-1/8 (29)	1/2 L x 11/16 W (13 L x 17 W)	Zinc/ Aluminum	(2) M4 X 1 in Truss Head Machine Screw (2) M4 X 1-9/16 in Truss Head Machine Screw	N/A
BP36682BMBG10	Pull	Brushed Matte Black/ Satin Nickel	5-1/16 (128) CTC	6-3/16 (157)	11/16 (17)	1-1/8 (29)	1/2 L x 11/16 W (13 L x 17 W)	Zinc/ Aluminum	(2) M4 X 1 in Truss Head Machine Screw (2) M4 X 1-9/16 in Truss Head Machine Screw	N/A
BP36682G1026	Pull	Satin Nickel/ Polished Chrome	5-1/16 (128) CTC	6-3/16 (157)	11/16 (17)	1-1/8 (29)	1/2 L x 11/16 W (13 L x 17 W)	Zinc/ Aluminum	(2) M4 X 1 in Truss Head Machine Screw (2) M4 X 1-9/16 in Truss Head Machine Screw	N/A
BP36683BCRBGL	Pull	Black Chrome/ Brushed Gold	6-5/16 (160) CTC	7-7/16 (189)	11/16 (17)	1-1/8 (29)	1/2 L x 11/16 W (13 L x 17 W)	Zinc/ Aluminum	(2) M4 X 1 in Truss Head Machine Screw (2) M4 X 1-9/16 in Truss Head Machine Screw	N/A
BP36683BGLBCR	Pull	Brushed Gold/ Black Chrome	6-5/16 (160) CTC	7-7/16 (189)	11/16 (17)	1-1/8 (29)	1/2 L x 11/16 W (13 L x 17 W)	Zinc/ Aluminum	(2) M4 X 1 in Truss Head Machine Screw (2) M4 X 1-9/16 in Truss Head Machine Screw	N/A
BP36683BGLG10	Pull	Brushed Gold/ Satin Nickel	6-5/16 (160) CTC	7-7/16 (189)	11/16 (17)	1-1/8 (29)	1/2 L x 11/16 W (13 L x 17 W)	Zinc/ Aluminum	(2) M4 X 1 in Truss Head Machine Screw (2) M4 X 1-9/16 in Truss Head Machine Screw	N/A
BP36683BMBBGL	Pull	Brushed Matte Black/ Brushed Gold	6-5/16 (160) CTC	7-7/16 (189)	11/16 (17)	1-1/8 (29)	1/2 L x 11/16 W (13 L x 17 W)	Zinc/ Aluminum	(2) M4 X 1 in Truss Head Machine Screw (2) M4 X 1-9/16 in Truss Head Machine Screw	N/A
BP36683BMBG10	Pull	Brushed Matte Black/ Satin Nickel	6-5/16 (160) CTC	7-7/16 (189)	11/16 (17)	1-1/8 (29)	1/2 L x 11/16 W (13 L x 17 W)	Zinc/ Aluminum	(2) M4 X 1 in Truss Head Machine Screw (2) M4 X 1-9/16 in Truss Head Machine Screw	N/A
BP36683G1026	Pull	Satin Nickel/ Polished Chrome	6-5/16 (160) CTC	7-7/16 (189)	11/16 (17)	1-1/8 (29)	1/2 L x 11/16 W (13 L x 17 W)	Zinc/ Aluminum	(2) M4 X 1 in Truss Head Machine Screw (2) M4 X 1-9/16 in Truss Head Machine Screw	N/A
BP36684BCRBGL	Pull	Black Chrome/ Brushed Gold	8-13/16 (224) CTC	9-15/16 (252)	11/16 (17)	1-1/8 (29)	1/2 L x 11/16 W (13 L x 17 W)	Zinc/ Aluminum	(2) M4 X 1 in Truss Head Machine Screw (2) M4 X 1-9/16 in Truss Head Machine Screw	N/A
BP36684BGLBCR	Pull	Brushed Gold/ Black Chrome	8-13/16 (224) CTC	9-15/16 (252)	11/16 (17)	1-1/8 (29)	1/2 L x 11/16 W (13 L x 17 W)	Zinc/ Aluminum	(2) M4 X 1 in Truss Head Machine Screw (2) M4 X 1-9/16 in Truss Head Machine Screw	N/A
BP36684BGLG10	Pull	Brushed Gold/ Satin Nickel	8-13/16 (224) CTC	9-15/16 (252)	11/16 (17)	1-1/8 (29)	1/2 L x 11/16 W (13 L x 17 W)	Zinc/ Aluminum	(2) M4 X 1 in Truss Head Machine Screw (2) M4 X 1-9/16 in Truss Head Machine Screw	N/A
BP36684BMBBGL	Pull	Brushed Matte Black/ Brushed Gold	8-13/16 (224) CTC	9-15/16 (252)	11/16 (17)	1-1/8 (29)	1/2 L x 11/16 W (13 L x 17 W)	Zinc/ Aluminum	(2) M4 X 1 in Truss Head Machine Screw (2) M4 X 1-9/16 in Truss Head Machine Screw	N/A
BP36684BMBG10	Pull	Brushed Matte Black/ Satin Nickel	8-13/16 (224) CTC	9-15/16 (252)	11/16 (17)	1-1/8 (29)	1/2 L x 11/16 W (13 L x 17 W)	Zinc/ Aluminum	(2) M4 X 1 in Truss Head Machine Screw (2) M4 X 1-9/16 in Truss Head Machine Screw	N/A
BP36684G1026	Pull	Satin Nickel/ Polished Chrome	8-13/16 (224) CTC	9-15/16 (252)	11/16 (17)	1-1/8 (29)	1/2 L x 11/16 W (13 L x 17 W)	Zinc/ Aluminum	(2) M4 X 1 in Truss Head Machine Screw (2) M4 X 1-9/16 in Truss Head Machine Screw	N/A

Mounting hardware included.  
The dimensional information provided here should be verified with the actual product prior to drilling or attempting to install the hardware.  
Please direct any questions you may have on the installation process to Amerock Customer Service (see back cover for contact information).

# PRODUCT INDEX

Product No.	Type	Finish	Product Detail in (mm)	Length in (mm)	Width in (mm)	Projection in (mm)	Base Dimensions in (mm)	Base Material	Mounting Hardware Included	ADA-Friendly
<b>Overton (continued) • p. 34</b>										
BP36685BCRBGL	Pull	Black Chrome/Brushed Gold	11-5/16 (288) CTC	12-7/16 (316)	11/16 (17)	1-1/8 (29)	1/2 L x 11/16 W (13 L x 17 W)	Zinc/Aluminum	(2) M4 X 1in Truss Head Machine Screw (2) M4 X 1-9/16in Truss Head Machine Screw	N/A
BP36685BGLBCR	Pull	Brushed Gold/Black Chrome	11-5/16 (288) CTC	12-7/16 (316)	11/16 (17)	1-1/8 (29)	1/2 L x 11/16 W (13 L x 17 W)	Zinc/Aluminum	(2) M4 X 1in Truss Head Machine Screw (2) M4 X 1-9/16in Truss Head Machine Screw	N/A
BP36685BGLG10	Pull	Brushed Gold/Satin Nickel	11-5/16 (288) CTC	12-7/16 (316)	11/16 (17)	1-1/8 (29)	1/2 L x 11/16 W (13 L x 17 W)	Zinc/Aluminum	(2) M4 X 1in Truss Head Machine Screw (2) M4 X 1-9/16in Truss Head Machine Screw	N/A
BP36685BMBBGL	Pull	Brushed Matte Black/Brushed Gold	11-5/16 (288) CTC	12-7/16 (316)	11/16 (17)	1-1/8 (29)	1/2 L x 11/16 W (13 L x 17 W)	Zinc/Aluminum	(2) M4 X 1in Truss Head Machine Screw (2) M4 X 1-9/16in Truss Head Machine Screw	N/A
BP36685BMBG10	Pull	Brushed Matte Black/Satin Nickel	11-5/16 (288) CTC	12-7/16 (316)	11/16 (17)	1-1/8 (29)	1/2 L x 11/16 W (13 L x 17 W)	Zinc/Aluminum	(2) M4 X 1in Truss Head Machine Screw (2) M4 X 1-9/16in Truss Head Machine Screw	N/A
BP36685G1026	Pull	Satin Nickel/Polished Chrome	11-5/16 (288) CTC	12-7/16 (316)	11/16 (17)	1-1/8 (29)	1/2 L x 11/16 W (13 L x 17 W)	Zinc/Aluminum	(2) M4 X 1in Truss Head Machine Screw (2) M4 X 1-9/16in Truss Head Machine Screw	N/A
<b>Westerly • p. 36</b>										
BP53717BBR	Knob	Black Bronze	1-5/16 (33) LGTH	1-5/16 (33)	9/16 (14)	1-1/16 (27)	13/16 L x 9/16 W (21 L x 14 W)	Zinc	(1) #8-32 x 1in Truss Head Machine Screw (1) #8-32 x 1-1/2in Truss Head Machine Screw	N/A
BP53717BBZ	Knob	Golden Champagne	1-5/16 (33) LGTH	1-5/16 (33)	9/16 (14)	1-1/16 (27)	13/16 L x 9/16 W (21 L x 14 W)	Zinc	(1) #8-32 x 1in Truss Head Machine Screw (1) #8-32 x 1-1/2in Truss Head Machine Screw	N/A
BP53717G10	Knob	Satin Nickel	1-5/16 (33) LGTH	1-5/16 (33)	9/16 (14)	1-1/16 (27)	13/16 L x 9/16 W (21 L x 14 W)	Zinc	(1) #8-32 x 1in Truss Head Machine Screw (1) #8-32 x 1-1/2in Truss Head Machine Screw	N/A
BP53717GPH	Knob	Graphite	1-5/16 (33) LGTH	1-5/16 (33)	9/16 (14)	1-1/16 (27)	13/16 L x 9/16 W (21 L x 14 W)	Zinc	(1) #8-32 x 1in Truss Head Machine Screw (1) #8-32 x 1-1/2in Truss Head Machine Screw	N/A
BP53717ORB	Knob	Oil-Rubbed Bronze	1-5/16 (33) LGTH	1-5/16 (33)	9/16 (14)	1-1/16 (27)	13/16 L x 9/16 W (21 L x 14 W)	Zinc	(1) #8-32 x 1in Truss Head Machine Screw (1) #8-32 x 1-1/2in Truss Head Machine Screw	N/A
BP53717PN	Knob	Polished Nickel	1-5/16 (33) LGTH	1-5/16 (33)	9/16 (14)	1-1/16 (27)	13/16 L x 9/16 W (21 L x 14 W)	Zinc	(1) #8-32 x 1in Truss Head Machine Screw (1) #8-32 x 1-1/2in Truss Head Machine Screw	N/A
BP53718BBR	Knob	Black Bronze	1-3/16 (30) DIA	1-3/16 (30)	N/A	1-3/16 (30)	13/16 L x 13/16 W (21 L x 21 W)	Zinc	(1) #8-32 x 1in Truss Head Machine Screw (1) #8-32 x 1-1/2in Truss Head Machine Screw	N/A
BP53718BBZ	Knob	Golden Champagne	1-3/16 (30) DIA	1-3/16 (30)	N/A	1-3/16 (30)	13/16 L x 13/16 W (21 L x 21 W)	Zinc	(1) #8-32 x 1in Truss Head Machine Screw (1) #8-32 x 1-1/2in Truss Head Machine Screw	N/A
BP53718G10	Knob	Satin Nickel	1-3/16 (30) DIA	1-3/16 (30)	N/A	1-3/16 (30)	13/16 L x 13/16 W (21 L x 21 W)	Zinc	(1) #8-32 x 1in Truss Head Machine Screw (1) #8-32 x 1-1/2in Truss Head Machine Screw	N/A
BP53718GPH	Knob	Graphite	1-3/16 (30) DIA	1-3/16 (30)	N/A	1-3/16 (30)	13/16 L x 13/16 W (21 L x 21 W)	Zinc	(1) #8-32 x 1in Truss Head Machine Screw (1) #8-32 x 1-1/2in Truss Head Machine Screw	N/A
BP53718ORB	Knob	Oil-Rubbed Bronze	1-3/16 (30) DIA	1-3/16 (30)	N/A	1-3/16 (30)	13/16 L x 13/16 W (21 L x 21 W)	Zinc	(1) #8-32 x 1in Truss Head Machine Screw (1) #8-32 x 1-1/2in Truss Head Machine Screw	N/A
BP53718PN	Knob	Polished Nickel	1-3/16 (30) DIA	1-3/16 (30)	N/A	1-3/16 (30)	13/16 L x 13/16 W (21 L x 21 W)	Zinc	(1) #8-32 x 1in Truss Head Machine Screw (1) #8-32 x 1-1/2in Truss Head Machine Screw	N/A
BP53719BBR	Pull	Black Bronze	3 (76) CTC	4-1/4 (108)	1/2 (13)	1-1/4 (32)	13/16 L x 1/2 W (21 L x 13 W)	Zinc	(2) #8-32 x 1in Truss Head Machine Screw (2) #8-32 x 1-1/2in Truss Head Machine Screw	N/A
BP53719BBZ	Pull	Golden Champagne	3 (76) CTC	4-1/4 (108)	1/2 (13)	1-1/4 (32)	13/16 L x 1/2 W (21 L x 13 W)	Zinc	(2) #8-32 x 1in Truss Head Machine Screw (2) #8-32 x 1-1/2in Truss Head Machine Screw	N/A
BP53719G10	Pull	Satin Nickel	3 (76) CTC	4-1/4 (108)	1/2 (13)	1-1/4 (32)	13/16 L x 1/2 W (21 L x 13 W)	Zinc	(2) #8-32 x 1in Truss Head Machine Screw (2) #8-32 x 1-1/2in Truss Head Machine Screw	N/A
BP53719GPH	Pull	Graphite	3 (76) CTC	4-1/4 (108)	1/2 (13)	1-1/4 (32)	13/16 L x 1/2 W (21 L x 13 W)	Zinc	(2) #8-32 x 1in Truss Head Machine Screw (2) #8-32 x 1-1/2in Truss Head Machine Screw	N/A
BP53719ORB	Pull	Oil-Rubbed Bronze	3 (76) CTC	4-1/4 (108)	1/2 (13)	1-1/4 (32)	13/16 L x 1/2 W (21 L x 13 W)	Zinc	(2) #8-32 x 1in Truss Head Machine Screw (2) #8-32 x 1-1/2in Truss Head Machine Screw	N/A
BP53719PN	Pull	Polished Nickel	3 (76) CTC	4-1/4 (108)	1/2 (13)	1-1/4 (32)	13/16 L x 1/2 W (21 L x 13 W)	Zinc	(2) #8-32 x 1in Truss Head Machine Screw (2) #8-32 x 1-1/2in Truss Head Machine Screw	N/A

Mounting hardware included.  
The dimensional information provided here should be verified with the actual product prior to drilling or attempting to install the hardware.  
Please direct any questions you may have on the installation process to Amerock Customer Service (see back cover for contact information).

# PRODUCT INDEX

Product No.	Type	Finish	Product Detail in (mm)	Length in (mm)	Width in (mm)	Projection in (mm)	Base Dimensions in (mm)	Base Material	Mounting Hardware Included	ADA-Friendly
Westerly (continued) • p. 36										
BP53720BBR	Pull	Black Bronze	3-3/4 (96) CTC	5-1/16 (128)	9/16 (14)	1-5/16 (33)	7/8 L x 9/16 W (22 L x 14 W)	Zinc	(2) #8-32 x 1in Truss Head Machine Screw (2) #8-32 x 1-1/2in Truss Head Machine Screw	✓
BP53720BBZ	Pull	Golden Champagne	3-3/4 (96) CTC	5-1/16 (128)	9/16 (14)	1-5/16 (33)	7/8 L x 9/16 W (22 L x 14 W)	Zinc	(2) #8-32 x 1in Truss Head Machine Screw (2) #8-32 x 1-1/2in Truss Head Machine Screw	✓
BP53720G10	Pull	Satin Nickel	3-3/4 (96) CTC	5-1/16 (128)	9/16 (14)	1-5/16 (33)	7/8 L x 9/16 W (22 L x 14 W)	Zinc	(2) #8-32 x 1in Truss Head Machine Screw (2) #8-32 x 1-1/2in Truss Head Machine Screw	✓
BP53720GPH	Pull	Graphite	3-3/4 (96) CTC	5-1/16 (128)	9/16 (14)	1-5/16 (33)	7/8 L x 9/16 W (22 L x 14 W)	Zinc	(2) #8-32 x 1in Truss Head Machine Screw (2) #8-32 x 1-1/2in Truss Head Machine Screw	✓
BP53720ORB	Pull	Oil-Rubbed Bronze	3-3/4 (96) CTC	5-1/16 (128)	9/16 (14)	1-5/16 (33)	7/8 L x 9/16 W (22 L x 14 W)	Zinc	(2) #8-32 x 1in Truss Head Machine Screw (2) #8-32 x 1-1/2in Truss Head Machine Screw	✓
BP53720PN	Pull	Polished Nickel	3-3/4 (96) CTC	5-1/16 (128)	9/16 (14)	1-5/16 (33)	7/8 L x 9/16 W (22 L x 14 W)	Zinc	(2) #8-32 x 1in Truss Head Machine Screw (2) #8-32 x 1-1/2in Truss Head Machine Screw	✓
BP53721BBR	Pull	Black Bronze	5-1/16 (128) CTC	6-1/4 (159)	9/16 (14)	1-5/16 (33)	7/8 L x 9/16 W (22 L x 14 W)	Zinc	(2) #8-32 x 1in Truss Head Machine Screw (2) #8-32 x 1-1/2in Truss Head Machine Screw	✓
BP53721BBZ	Pull	Golden Champagne	5-1/16 (128) CTC	6-1/4 (159)	9/16 (14)	1-5/16 (33)	7/8 L x 9/16 W (22 L x 14 W)	Zinc	(2) #8-32 x 1in Truss Head Machine Screw (2) #8-32 x 1-1/2in Truss Head Machine Screw	✓
BP53721G10	Pull	Satin Nickel	5-1/16 (128) CTC	6-1/4 (159)	9/16 (14)	1-5/16 (33)	7/8 L x 9/16 W (22 L x 14 W)	Zinc	(2) #8-32 x 1in Truss Head Machine Screw (2) #8-32 x 1-1/2in Truss Head Machine Screw	✓
BP53721GPH	Pull	Graphite	5-1/16 (128) CTC	6-1/4 (159)	9/16 (14)	1-5/16 (33)	7/8 L x 9/16 W (22 L x 14 W)	Zinc	(2) #8-32 x 1in Truss Head Machine Screw (2) #8-32 x 1-1/2in Truss Head Machine Screw	✓
BP53721ORB	Pull	Oil-Rubbed Bronze	5-1/16 (128) CTC	6-1/4 (159)	9/16 (14)	1-5/16 (33)	7/8 L x 9/16 W (22 L x 14 W)	Zinc	(2) #8-32 x 1in Truss Head Machine Screw (2) #8-32 x 1-1/2in Truss Head Machine Screw	✓
BP53721PN	Pull	Polished Nickel	5-1/16 (128) CTC	6-1/4 (159)	9/16 (14)	1-5/16 (33)	7/8 L x 9/16 W (22 L x 14 W)	Zinc	(2) #8-32 x 1in Truss Head Machine Screw (2) #8-32 x 1-1/2in Truss Head Machine Screw	✓
BP53722BBR	Pull	Black Bronze	6-5/16 (160) CTC	7-9/16 (192)	5/8 (16)	1-3/8 (35)	7/8 L x 9/16 W (22 L x 14 W)	Zinc	(2) #8-32 x 1in Truss Head Machine Screw (2) #8-32 x 1-1/2in Truss Head Machine Screw	✓
BP53722BBZ	Pull	Golden Champagne	6-5/16 (160) CTC	7-9/16 (192)	5/8 (16)	1-3/8 (35)	7/8 L x 9/16 W (22 L x 14 W)	Zinc	(2) #8-32 x 1in Truss Head Machine Screw (2) #8-32 x 1-1/2in Truss Head Machine Screw	✓
BP53722G10	Pull	Satin Nickel	6-5/16 (160) CTC	7-9/16 (192)	5/8 (16)	1-3/8 (35)	7/8 L x 9/16 W (22 L x 14 W)	Zinc	(2) #8-32 x 1in Truss Head Machine Screw (2) #8-32 x 1-1/2in Truss Head Machine Screw	✓
BP53722GPH	Pull	Graphite	6-5/16 (160) CTC	7-9/16 (192)	5/8 (16)	1-3/8 (35)	7/8 L x 9/16 W (22 L x 14 W)	Zinc	(2) #8-32 x 1in Truss Head Machine Screw (2) #8-32 x 1-1/2in Truss Head Machine Screw	✓
BP53722ORB	Pull	Oil-Rubbed Bronze	6-5/16 (160) CTC	7-9/16 (192)	5/8 (16)	1-3/8 (35)	7/8 L x 9/16 W (22 L x 14 W)	Zinc	(2) #8-32 x 1in Truss Head Machine Screw (2) #8-32 x 1-1/2in Truss Head Machine Screw	✓
BP53722PN	Pull	Polished Nickel	6-5/16 (160) CTC	7-9/16 (192)	5/8 (16)	1-3/8 (35)	7/8 L x 9/16 W (22 L x 14 W)	Zinc	(2) #8-32 x 1in Truss Head Machine Screw (2) #8-32 x 1-1/2in Truss Head Machine Screw	✓
BP54023BBR	Appliance Pull	Black Bronze	12 (305) CTC	13-13/16 (351)	3/4 (19)	1-15/16 (49)	1-3/16 L x 3/4 W (30 L x 19 W)	Zinc	(2) #10-24 x 3/4in Pan Head Machine Screw (2) #10-24 x 1in Pan Head Machine Screw (2) #10-24 x 1-1/4in Pan Head Machine Screw (2) #10-24 x 1-1/2in Pan Head Machine Screw (2) #10-24 x 1-3/4in Pan Head Machine Screw	✓
BP54023BBZ	Appliance Pull	Golden Champagne	12 (305) CTC	13-13/16 (351)	3/4 (19)	1-15/16 (49)	1-3/16 L x 3/4 W (30 L x 19 W)	Zinc	(2) #10-24 x 3/4in Pan Head Machine Screw (2) #10-24 x 1in Pan Head Machine Screw (2) #10-24 x 1-1/4in Pan Head Machine Screw (2) #10-24 x 1-1/2in Pan Head Machine Screw (2) #10-24 x 1-3/4in Pan Head Machine Screw	✓
BP54023G10	Appliance Pull	Satin Nickel	12 (305) CTC	13-13/16 (351)	3/4 (19)	1-15/16 (49)	1-3/16 L x 3/4 W (30 L x 19 W)	Zinc	(2) #10-24 x 3/4in Pan Head Machine Screw (2) #10-24 x 1in Pan Head Machine Screw (2) #10-24 x 1-1/4in Pan Head Machine Screw (2) #10-24 x 1-1/2in Pan Head Machine Screw (2) #10-24 x 1-3/4in Pan Head Machine Screw	✓

Mounting hardware included.  
The dimensional information provided here should be verified with the actual product prior to drilling or attempting to install the hardware.  
Please direct any questions you may have on the installation process to Amerock Customer Service (see back cover for contact information).

# PRODUCT INDEX

Product No.	Type	Finish	Product Detail in (mm)	Length in (mm)	Width in (mm)	Projection in (mm)	Base Dimensions in (mm)	Base Material	Mounting Hardware Included	ADA-Friendly
<b>Westerly (continued) • p. 36</b>										
BP54023GPH	Appliance Pull	Graphite	12 (305) CTC	13-13/16 (351)	3/4 (19)	1-15/16 (49)	1-3/16 L x 3/4 W (30 L x 19 W)	Zinc	(2) #10-24 x 3/4in Pan Head Machine Screw (2) #10-24 x 1in Pan Head Machine Screw (2) #10-24 x 1-1/4in Pan Head Machine Screw (2) #10-24 x 1-1/2in Pan Head Machine Screw (2) #10-24 x 1-3/4in Pan Head Machine Screw	✓
BP54023ORB	Appliance Pull	Oil-Rubbed Bronze	12 (305) CTC	13-13/16 (351)	3/4 (19)	1-15/16 (49)	1-3/16 L x 3/4 W (30 L x 19 W)	Zinc	(2) #10-24 x 3/4in Pan Head Machine Screw (2) #10-24 x 1in Pan Head Machine Screw (2) #10-24 x 1-1/4in Pan Head Machine Screw (2) #10-24 x 1-1/2in Pan Head Machine Screw (2) #10-24 x 1-3/4in Pan Head Machine Screw	✓
BP54023PN	Appliance Pull	Polished Nickel	12 (305) CTC	13-13/16 (351)	3/4 (19)	1-15/16 (49)	1-3/16 L x 3/4 W (30 L x 19 W)	Zinc	(2) #10-24 x 3/4in Pan Head Machine Screw (2) #10-24 x 1in Pan Head Machine Screw (2) #10-24 x 1-1/4in Pan Head Machine Screw (2) #10-24 x 1-1/2in Pan Head Machine Screw (2) #10-24 x 1-3/4in Pan Head Machine Screw	✓
BP54024BBR	Appliance Pull	Black Bronze	18 (457) CTC	19-15/16 (506)	7/8 (22)	2 (51)	1-5/16 L x 7/8 W (33 L x 22 W)	Zinc	(2) #10-24 x 3/4in Pan Head Machine Screw (2) #10-24 x 1in Pan Head Machine Screw (2) #10-24 x 1-1/4in Pan Head Machine Screw (2) #10-24 x 1-1/2in Pan Head Machine Screw (2) #10-24 x 1-3/4in Pan Head Machine Screw	✓
BP54024BBZ	Appliance Pull	Golden Champagne	18 (457) CTC	19-15/16 (506)	7/8 (22)	2 (51)	1-5/16 L x 7/8 W (33 L x 22 W)	Zinc	(2) #10-24 x 3/4in Pan Head Machine Screw (2) #10-24 x 1in Pan Head Machine Screw (2) #10-24 x 1-1/4in Pan Head Machine Screw (2) #10-24 x 1-1/2in Pan Head Machine Screw (2) #10-24 x 1-3/4in Pan Head Machine Screw	✓
BP54024G10	Appliance Pull	Satin Nickel	18 (457) CTC	19-15/16 (506)	7/8 (22)	2 (51)	1-5/16 L x 7/8 W (33 L x 22 W)	Zinc	(2) #10-24 x 3/4in Pan Head Machine Screw (2) #10-24 x 1in Pan Head Machine Screw (2) #10-24 x 1-1/4in Pan Head Machine Screw (2) #10-24 x 1-1/2in Pan Head Machine Screw (2) #10-24 x 1-3/4in Pan Head Machine Screw	✓
BP54024GPH	Appliance Pull	Graphite	18 (457) CTC	19-15/16 (506)	7/8 (22)	2 (51)	1-5/16 L x 7/8 W (33 L x 22 W)	Zinc	(2) #10-24 x 3/4in Pan Head Machine Screw (2) #10-24 x 1in Pan Head Machine Screw (2) #10-24 x 1-1/4in Pan Head Machine Screw (2) #10-24 x 1-1/2in Pan Head Machine Screw (2) #10-24 x 1-3/4in Pan Head Machine Screw	✓
BP54024ORB	Appliance Pull	Oil-Rubbed Bronze	18 (457) CTC	19-15/16 (506)	7/8 (22)	2 (51)	1-5/16 L x 7/8 W (33 L x 22 W)	Zinc	(2) #10-24 x 3/4in Pan Head Machine Screw (2) #10-24 x 1in Pan Head Machine Screw (2) #10-24 x 1-1/4in Pan Head Machine Screw (2) #10-24 x 1-1/2in Pan Head Machine Screw (2) #10-24 x 1-3/4in Pan Head Machine Screw	✓
BP54024PN	Appliance Pull	Polished Nickel	18 (457) CTC	19-15/16 (506)	7/8 (22)	2 (51)	1-5/16 L x 7/8 W (33 L x 22 W)	Zinc	(2) #10-24 x 3/4in Pan Head Machine Screw (2) #10-24 x 1in Pan Head Machine Screw (2) #10-24 x 1-1/4in Pan Head Machine Screw (2) #10-24 x 1-1/2in Pan Head Machine Screw (2) #10-24 x 1-3/4in Pan Head Machine Screw	✓
<b>Kane • p. 38</b>										
BP53700BBR	Knob	Black Bronze	1-3/16 (30) DIA	1-3/16 (30)	N/A	1-3/16 (30)	11/16 L x 11/16 W (17 L x 17 W)	Zinc	(1) #8-32 x 1in Truss Head Machine Screw (1) #8-32 x 1-1/2in Truss Head Machine Screw	N/A
BP53700BBZ	Knob	Golden Champagne	1-3/16 (30) DIA	1-3/16 (30)	N/A	1-3/16 (30)	11/16 L x 11/16 W (17 L x 17 W)	Zinc	(1) #8-32 x 1in Truss Head Machine Screw (1) #8-32 x 1-1/2in Truss Head Machine Screw	N/A
BP53700G10	Knob	Satin Nickel	1-3/16 (30) DIA	1-3/16 (30)	N/A	1-3/16 (30)	11/16 L x 11/16 W (17 L x 17 W)	Zinc	(1) #8-32 x 1in Truss Head Machine Screw (1) #8-32 x 1-1/2in Truss Head Machine Screw	N/A
BP53700ORB	Knob	Oil-Rubbed Bronze	1-3/16 (30) DIA	1-3/16 (30)	N/A	1-3/16 (30)	11/16 L x 11/16 W (17 L x 17 W)	Zinc	(1) #8-32 x 1in Truss Head Machine Screw (1) #8-32 x 1-1/2in Truss Head Machine Screw	N/A

Mounting hardware included.  
The dimensional information provided here should be verified with the actual product prior to drilling or attempting to install the hardware.  
Please direct any questions you may have on the installation process to Amerock Customer Service (see back cover for contact information).

# PRODUCT INDEX

Product No.	Type	Finish	Product Detail in (mm)	Length in (mm)	Width in (mm)	Projection in (mm)	Base Dimensions in (mm)	Base Material	Mounting Hardware Included	ADA-Friendly
Kane (continued) • p. 38										
BP53700PN	Knob	Polished Nickel	1-3/16 (30) DIA	1-3/16 (30)	N/A	1-3/16 (30)	11/16 L x 11/16 W (17 L x 17 W)	Zinc	(1) #8-32 x 1in Truss Head Machine Screw (1) #8-32 x 1-1/2in Truss Head Machine Screw	N/A
BP53700WN	Knob	Weathered Nickel	1-3/16 (30) DIA	1-3/16 (30)	N/A	1-3/16 (30)	11/16 L x 11/16 W (17 L x 17 W)	Zinc	(1) #8-32 x 1in Truss Head Machine Screw (1) #8-32 x 1-1/2in Truss Head Machine Screw	N/A
BP53701BBR	Pull	Black Bronze	3 (76) CTC	3-5/8 (92)	5/8 (16)	1-1/8 (29)	5/8 L x 5/8 W (16 L x 16 W)	Zinc	(2) #8-32 x 1in Truss Head Machine Screw (2) #8-32 x 1-1/2in Truss Head Machine Screw	N/A
BP53701BBZ	Pull	Golden Champagne	3 (76) CTC	3-5/8 (92)	5/8 (16)	1-1/8 (29)	5/8 L x 5/8 W (16 L x 16 W)	Zinc	(2) #8-32 x 1in Truss Head Machine Screw (2) #8-32 x 1-1/2in Truss Head Machine Screw	N/A
BP53701G10	Pull	Satin Nickel	3 (76) CTC	3-5/8 (92)	5/8 (16)	1-1/8 (29)	5/8 L x 5/8 W (16 L x 16 W)	Zinc	(2) #8-32 x 1in Truss Head Machine Screw (2) #8-32 x 1-1/2in Truss Head Machine Screw	N/A
BP53701ORB	Pull	Oil-Rubbed Bronze	3 (76) CTC	3-5/8 (92)	5/8 (16)	1-1/8 (29)	5/8 L x 5/8 W (16 L x 16 W)	Zinc	(2) #8-32 x 1in Truss Head Machine Screw (2) #8-32 x 1-1/2in Truss Head Machine Screw	N/A
BP53701PN	Pull	Polished Nickel	3 (76) CTC	3-5/8 (92)	5/8 (16)	1-1/8 (29)	5/8 L x 5/8 W (16 L x 16 W)	Zinc	(2) #8-32 x 1in Truss Head Machine Screw (2) #8-32 x 1-1/2in Truss Head Machine Screw	N/A
BP53701WN	Pull	Weathered Nickel	3 (76) CTC	3-5/8 (92)	5/8 (16)	1-1/8 (29)	5/8 L x 5/8 W (16 L x 16 W)	Zinc	(2) #8-32 x 1in Truss Head Machine Screw (2) #8-32 x 1-1/2in Truss Head Machine Screw	N/A
BP53702BBR	Pull	Black Bronze	3-3/4 (96) CTC	4-7/16 (113)	5/8 (16)	1-1/8 (29)	5/8 L x 5/8 W (16 L x 16 W)	Zinc	(2) #8-32 x 1in Truss Head Machine Screw (2) #8-32 x 1-1/2in Truss Head Machine Screw	✓
BP53702BBZ	Pull	Golden Champagne	3-3/4 (96) CTC	4-7/16 (113)	5/8 (16)	1-1/8 (29)	5/8 L x 5/8 W (16 L x 16 W)	Zinc	(2) #8-32 x 1in Truss Head Machine Screw (2) #8-32 x 1-1/2in Truss Head Machine Screw	✓
BP53702G10	Pull	Satin Nickel	3-3/4 (96) CTC	4-7/16 (113)	5/8 (16)	1-1/8 (29)	5/8 L x 5/8 W (16 L x 16 W)	Zinc	(2) #8-32 x 1in Truss Head Machine Screw (2) #8-32 x 1-1/2in Truss Head Machine Screw	✓
BP53702ORB	Pull	Oil-Rubbed Bronze	3-3/4 (96) CTC	4-7/16 (113)	5/8 (16)	1-1/8 (29)	5/8 L x 5/8 W (16 L x 16 W)	Zinc	(2) #8-32 x 1in Truss Head Machine Screw (2) #8-32 x 1-1/2in Truss Head Machine Screw	✓
BP53702PN	Pull	Polished Nickel	3-3/4 (96) CTC	4-7/16 (113)	5/8 (16)	1-1/8 (29)	5/8 L x 5/8 W (16 L x 16 W)	Zinc	(2) #8-32 x 1in Truss Head Machine Screw (2) #8-32 x 1-1/2in Truss Head Machine Screw	✓
BP53702RB	Pull	Roman Bronze	3-3/4 (96) CTC	4-7/16 (113)	5/8 (16)	1-1/8 (29)	5/8 L x 5/8 W (16 L x 16 W)	Zinc	(2) #8-32 x 1in Truss Head Machine Screw (2) #8-32 x 1-1/2in Truss Head Machine Screw	✓
BP53702WN	Pull	Weathered Nickel	3-3/4 (96) CTC	4-7/16 (113)	5/8 (16)	1-1/8 (29)	5/8 L x 5/8 W (16 L x 16 W)	Zinc	(2) #8-32 x 1in Truss Head Machine Screw (2) #8-32 x 1-1/2in Truss Head Machine Screw	✓
BP53801BBR	Cup Pull	Black Bronze	3-3/4 (96) CTC	4-3/8 (111)	1-5/16 (33)	1 (25)	4-3/8 L x 1-5/16 W (111 L x 33 W)	Zinc	(2) #8-32 x 1in Truss Head Machine Screw (2) #8-32 x 1-1/2in Truss Head Machine Screw	N/A
BP53801BBZ	Cup Pull	Golden Champagne	3-3/4 (96) CTC	4-3/8 (111)	1-5/16 (33)	1 (25)	4-3/8 L x 1-5/16 W (111 L x 33 W)	Zinc	(2) #8-32 x 1in Truss Head Machine Screw (2) #8-32 x 1-1/2in Truss Head Machine Screw	N/A
BP53801G10	Cup Pull	Satin Nickel	3-3/4 (96) CTC	4-3/8 (111)	1-5/16 (33)	1 (25)	4-3/8 L x 1-5/16 W (111 L x 33 W)	Zinc	(2) #8-32 x 1in Truss Head Machine Screw (2) #8-32 x 1-1/2in Truss Head Machine Screw	N/A
BP53801ORB	Cup Pull	Oil-Rubbed Bronze	3-3/4 (96) CTC	4-3/8 (111)	1-5/16 (33)	1 (25)	4-3/8 L x 1-5/16 W (111 L x 33 W)	Zinc	(2) #8-32 x 1in Truss Head Machine Screw (2) #8-32 x 1-1/2in Truss Head Machine Screw	N/A
BP53801PN	Cup Pull	Polished Nickel	3-3/4 (96) CTC	4-3/8 (111)	1-5/16 (33)	1 (25)	4-3/8 L x 1-5/16 W (111 L x 33 W)	Zinc	(2) #8-32 x 1in Truss Head Machine Screw (2) #8-32 x 1-1/2in Truss Head Machine Screw	N/A
BP53801WN	Cup Pull	Weathered Nickel	3-3/4 (96) CTC	4-3/8 (111)	1-5/16 (33)	1 (25)	4-3/8 L x 1-5/16 W (111 L x 33 W)	Zinc	(2) #8-32 x 1in Truss Head Machine Screw (2) #8-32 x 1-1/2in Truss Head Machine Screw	N/A
BP53802BBR	Pull	Black Bronze	5-1/16 (128) CTC	5-11/16 (144)	11/16 (17)	1-3/16 (30)	5/8 L x 5/8 W (16 L x 16 W)	Zinc	(2) #8-32 x 1in Truss Head Machine Screw (2) #8-32 x 1-1/2in Truss Head Machine Screw	✓
BP53802BBZ	Pull	Golden Champagne	5-1/16 (128) CTC	5-11/16 (144)	11/16 (17)	1-3/16 (30)	5/8 L x 5/8 W (16 L x 16 W)	Zinc	(2) #8-32 x 1in Truss Head Machine Screw (2) #8-32 x 1-1/2in Truss Head Machine Screw	✓
BP53802G10	Pull	Satin Nickel	5-1/16 (128) CTC	5-11/16 (144)	11/16 (17)	1-3/16 (30)	5/8 L x 5/8 W (16 L x 16 W)	Zinc	(2) #8-32 x 1in Truss Head Machine Screw (2) #8-32 x 1-1/2in Truss Head Machine Screw	✓
BP53802ORB	Pull	Oil-Rubbed Bronze	5-1/16 (128) CTC	5-11/16 (144)	11/16 (17)	1-3/16 (30)	5/8 L x 5/8 W (16 L x 16 W)	Zinc	(2) #8-32 x 1in Truss Head Machine Screw (2) #8-32 x 1-1/2in Truss Head Machine Screw	✓

Mounting hardware included.  
The dimensional information provided here should be verified with the actual product prior to drilling or attempting to install the hardware.  
Please direct any questions you may have on the installation process to Amerock Customer Service (see back cover for contact information).



# PRODUCT INDEX

Product No.	Type	Finish	Product Detail in (mm)	Length in (mm)	Width in (mm)	Projection in (mm)	Base Dimensions in (mm)	Base Material	Mounting Hardware Included	ADA-Friendly
<b>Kane (continued) • p. 38</b>										
BP53802PN	Pull	Polished Nickel	5-1/16 (128) CTC	5-11/16 (144)	11/16 (17)	1-3/16 (30)	5/8 L x 5/8 W (16 L x 16 W)	Zinc	(2) #8-32 x 1in Truss Head Machine Screw (2) #8-32 x 1-1/2in Truss Head Machine Screw	✓
BP53802WN	Pull	Weathered Nickel	5-1/16 (128) CTC	5-11/16 (144)	11/16 (17)	1-3/16 (30)	5/8 L x 5/8 W (16 L x 16 W)	Zinc	(2) #8-32 x 1in Truss Head Machine Screw (2) #8-32 x 1-1/2in Truss Head Machine Screw	✓
BP53803BBR	Pull	Black Bronze	6-5/16 (160) CTC	7 (178)	11/16 (17)	1-1/4 (32)	5/8 L x 5/8 W (16 L x 16 W)	Zinc	(2) #8-32 x 1in Truss Head Machine Screw (2) #8-32 x 1-1/2in Truss Head Machine Screw	✓
BP53803BBZ	Pull	Golden Champagne	6-5/16 (160) CTC	7 (178)	11/16 (17)	1-1/4 (32)	5/8 L x 5/8 W (16 L x 16 W)	Zinc	(2) #8-32 x 1in Truss Head Machine Screw (2) #8-32 x 1-1/2in Truss Head Machine Screw	✓
BP53803G10	Pull	Satin Nickel	6-5/16 (160) CTC	7 (178)	11/16 (17)	1-1/4 (32)	5/8 L x 5/8 W (16 L x 16 W)	Zinc	(2) #8-32 x 1in Truss Head Machine Screw (2) #8-32 x 1-1/2in Truss Head Machine Screw	✓
BP53803ORB	Pull	Oil-Rubbed Bronze	6-5/16 (160) CTC	7 (178)	11/16 (17)	1-1/4 (32)	5/8 L x 5/8 W (16 L x 16 W)	Zinc	(2) #8-32 x 1in Truss Head Machine Screw (2) #8-32 x 1-1/2in Truss Head Machine Screw	✓
BP53803PN	Pull	Polished Nickel	6-5/16 (160) CTC	7 (178)	11/16 (17)	1-1/4 (32)	5/8 L x 5/8 W (16 L x 16 W)	Zinc	(2) #8-32 x 1in Truss Head Machine Screw (2) #8-32 x 1-1/2in Truss Head Machine Screw	✓
BP53803WN	Pull	Weathered Nickel	6-5/16 (160) CTC	7 (178)	11/16 (17)	1-1/4 (32)	5/8 L x 5/8 W (16 L x 16 W)	Zinc	(2) #8-32 x 1in Truss Head Machine Screw (2) #8-32 x 1-1/2in Truss Head Machine Screw	✓
BP53804BBR	Appliance Pull	Black Bronze	8 (203) CTC	8-7/8 (225)	7/8 (22)	1-5/8 (41)	7/8 L x 7/8 W (22 L x 22 W)	Zinc	(2) #10-24 x 3/4in Pan Head Machine Screw (2) #10-24 x 1in Pan Head Machine Screw (2) #10-24 x 1-1/4in Pan Head Machine Screw (2) #10-24 x 1-1/2in Pan Head Machine Screw (2) #10-24 x 1-3/4in Pan Head Machine Screw	✓
BP53804BBZ	Appliance Pull	Golden Champagne	8 (203) CTC	8-7/8 (225)	7/8 (22)	1-5/8 (41)	7/8 L x 7/8 W (22 L x 22 W)	Zinc	(2) #10-24 x 3/4in Pan Head Machine Screw (2) #10-24 x 1in Pan Head Machine Screw (2) #10-24 x 1-1/4in Pan Head Machine Screw (2) #10-24 x 1-1/2in Pan Head Machine Screw (2) #10-24 x 1-3/4in Pan Head Machine Screw	✓
BP53804G10	Appliance Pull	Satin Nickel	8 (203) CTC	8-7/8 (225)	7/8 (22)	1-5/8 (41)	7/8 L x 7/8 W (22 L x 22 W)	Zinc	(2) #10-24 x 3/4in Pan Head Machine Screw (2) #10-24 x 1in Pan Head Machine Screw (2) #10-24 x 1-1/4in Pan Head Machine Screw (2) #10-24 x 1-1/2in Pan Head Machine Screw (2) #10-24 x 1-3/4in Pan Head Machine Screw	✓
BP53804ORB	Appliance Pull	Oil-Rubbed Bronze	8 (203) CTC	8-7/8 (225)	7/8 (22)	1-5/8 (41)	7/8 L x 7/8 W (22 L x 22 W)	Zinc	(2) #10-24 x 3/4in Pan Head Machine Screw (2) #10-24 x 1in Pan Head Machine Screw (2) #10-24 x 1-1/4in Pan Head Machine Screw (2) #10-24 x 1-1/2in Pan Head Machine Screw (2) #10-24 x 1-3/4in Pan Head Machine Screw	✓
BP53804PN	Appliance Pull	Polished Nickel	8 (203) CTC	8-7/8 (225)	7/8 (22)	1-5/8 (41)	7/8 L x 7/8 W (22 L x 22 W)	Zinc	(2) #10-24 x 3/4in Pan Head Machine Screw (2) #10-24 x 1in Pan Head Machine Screw (2) #10-24 x 1-1/4in Pan Head Machine Screw (2) #10-24 x 1-1/2in Pan Head Machine Screw (2) #10-24 x 1-3/4in Pan Head Machine Screw	✓
BP53804WN	Appliance Pull	Weathered Nickel	8 (203) CTC	8-7/8 (225)	7/8 (22)	1-5/8 (41)	7/8 L x 7/8 W (22 L x 22 W)	Zinc	(2) #10-24 x 3/4in Pan Head Machine Screw (2) #10-24 x 1in Pan Head Machine Screw (2) #10-24 x 1-1/4in Pan Head Machine Screw (2) #10-24 x 1-1/2in Pan Head Machine Screw (2) #10-24 x 1-3/4in Pan Head Machine Screw	✓
BP53805BBR	Appliance Pull	Black Bronze	12 (305) CTC	12-15/16 (329)	1 (25)	1-11/16 (43)	1 L x 1 W (25 L x 25 W)	Zinc	(2) #10-24 x 3/4in Pan Head Machine Screw (2) #10-24 x 1in Pan Head Machine Screw (2) #10-24 x 1-1/4in Pan Head Machine Screw (2) #10-24 x 1-1/2in Pan Head Machine Screw (2) #10-24 x 1-3/4in Pan Head Machine Screw	✓
BP53805BBZ	Appliance Pull	Golden Champagne	12 (305) CTC	12-15/16 (329)	1 (25)	1-11/16 (43)	1 L x 1 W (25 L x 25 W)	Zinc	(2) #10-24 x 3/4in Pan Head Machine Screw (2) #10-24 x 1in Pan Head Machine Screw (2) #10-24 x 1-1/4in Pan Head Machine Screw (2) #10-24 x 1-1/2in Pan Head Machine Screw (2) #10-24 x 1-3/4in Pan Head Machine Screw	✓

Mounting hardware included.  
The dimensional information provided here should be verified with the actual product prior to drilling or attempting to install the hardware.  
Please direct any questions you may have on the installation process to Amerock Customer Service (see back cover for contact information).

# PRODUCT INDEX

Product No.	Type	Finish	Product Detail in (mm)	Length in (mm)	Width in (mm)	Projection in (mm)	Base Dimensions in (mm)	Base Material	Mounting Hardware Included	ADA-Friendly
Kane (continued) • p. 38										
BP53805G10	Appliance Pull	Satin Nickel	12 (305) CTC	12-15/16 (329)	1 (25)	1-11/16 (43)	1 L x 1 W (25 L x 25 W)	Zinc	(2) #10-24 x 3/4in Pan Head Machine Screw (2) #10-24 x 1in Pan Head Machine Screw (2) #10-24 x 1-1/4in Pan Head Machine Screw (2) #10-24 x 1-1/2in Pan Head Machine Screw (2) #10-24 x 1-3/4in Pan Head Machine Screw	✓
BP53805ORB	Appliance Pull	Oil-Rubbed Bronze	12 (305) CTC	12-15/16 (329)	1 (25)	1-11/16 (43)	1 L x 1 W (25 L x 25 W)	Zinc	(2) #10-24 x 3/4in Pan Head Machine Screw (2) #10-24 x 1in Pan Head Machine Screw (2) #10-24 x 1-1/4in Pan Head Machine Screw (2) #10-24 x 1-1/2in Pan Head Machine Screw (2) #10-24 x 1-3/4in Pan Head Machine Screw	✓
BP53805PN	Appliance Pull	Polished Nickel	12 (305) CTC	12-15/16 (329)	1 (25)	1-11/16 (43)	1 L x 1 W (25 L x 25 W)	Zinc	(2) #10-24 x 3/4in Pan Head Machine Screw (2) #10-24 x 1in Pan Head Machine Screw (2) #10-24 x 1-1/4in Pan Head Machine Screw (2) #10-24 x 1-1/2in Pan Head Machine Screw (2) #10-24 x 1-3/4in Pan Head Machine Screw	✓
BP53805WN	Appliance Pull	Weathered Nickel	12 (305) CTC	12-15/16 (329)	1 (25)	1-11/16 (43)	1 L x 1 W (25 L x 25 W)	Zinc	(2) #10-24 x 3/4in Pan Head Machine Screw (2) #10-24 x 1in Pan Head Machine Screw (2) #10-24 x 1-1/4in Pan Head Machine Screw (2) #10-24 x 1-1/2in Pan Head Machine Screw (2) #10-24 x 1-3/4in Pan Head Machine Screw	✓
BP53806BBR	Appliance Pull	Black Bronze	18 (457) CTC	19-1/4 (489)	1-1/4 (32)	1-13/16 (46)	1-1/4 L x 1-1/4 W (32 L x 32 W)	Zinc	(2) #10-24 x 3/4in Pan Head Machine Screw (2) #10-24 x 1in Pan Head Machine Screw (2) #10-24 x 1-1/4in Pan Head Machine Screw (2) #10-24 x 1-1/2in Pan Head Machine Screw (2) #10-24 x 1-3/4in Pan Head Machine Screw	✓
BP53806BBZ	Appliance Pull	Golden Champagne	18 (457) CTC	19-1/4 (489)	1-1/4 (32)	1-13/16 (46)	1-1/4 L x 1-1/4 W (32 L x 32 W)	Zinc	(2) #10-24 x 3/4in Pan Head Machine Screw (2) #10-24 x 1in Pan Head Machine Screw (2) #10-24 x 1-1/4in Pan Head Machine Screw (2) #10-24 x 1-1/2in Pan Head Machine Screw (2) #10-24 x 1-3/4in Pan Head Machine Screw	✓
BP53806G10	Appliance Pull	Satin Nickel	18 (457) CTC	19-1/4 (489)	1-1/4 (32)	1-13/16 (46)	1-1/4 L x 1-1/4 W (32 L x 32 W)	Zinc	(2) #10-24 x 3/4in Pan Head Machine Screw (2) #10-24 x 1in Pan Head Machine Screw (2) #10-24 x 1-1/4in Pan Head Machine Screw (2) #10-24 x 1-1/2in Pan Head Machine Screw (2) #10-24 x 1-3/4in Pan Head Machine Screw	✓
BP53806ORB	Appliance Pull	Oil-Rubbed Bronze	18 (457) CTC	19-1/4 (489)	1-1/4 (32)	1-13/16 (46)	1-1/4 L x 1-1/4 W (32 L x 32 W)	Zinc	(2) #10-24 x 3/4in Pan Head Machine Screw (2) #10-24 x 1in Pan Head Machine Screw (2) #10-24 x 1-1/4in Pan Head Machine Screw (2) #10-24 x 1-1/2in Pan Head Machine Screw (2) #10-24 x 1-3/4in Pan Head Machine Screw	✓
BP53806PN	Appliance Pull	Polished Nickel	18 (457) CTC	19-1/4 (489)	1-1/4 (32)	1-13/16 (46)	1-1/4 L x 1-1/4 W (32 L x 32 W)	Zinc	(2) #10-24 x 3/4in Pan Head Machine Screw (2) #10-24 x 1in Pan Head Machine Screw (2) #10-24 x 1-1/4in Pan Head Machine Screw (2) #10-24 x 1-1/2in Pan Head Machine Screw (2) #10-24 x 1-3/4in Pan Head Machine Screw	✓
BP53806WN	Appliance Pull	Weathered Nickel	18 (457) CTC	19-1/4 (489)	1-1/4 (32)	1-13/16 (46)	1-1/4 L x 1-1/4 W (32 L x 32 W)	Zinc	(2) #10-24 x 3/4in Pan Head Machine Screw (2) #10-24 x 1in Pan Head Machine Screw (2) #10-24 x 1-1/4in Pan Head Machine Screw (2) #10-24 x 1-1/2in Pan Head Machine Screw (2) #10-24 x 1-3/4in Pan Head Machine Screw	✓
BP538072BBR	Knob	Black Bronze	1-5/8 (41) DIA	1-5/8 (41)	N/A	1-1/2 (38)	1 L x 1 W (25 L x 25 W)	Zinc	(1) #8-32 x 1in Truss Head Machine Screw (1) #8-32 x 1-1/2in Truss Head Machine Screw	N/A
BP538072BBZ	Knob	Golden Champagne	1-5/8 (41) DIA	1-5/8 (41)	N/A	1-1/2 (38)	1 L x 1 W (25 L x 25 W)	Zinc	(1) #8-32 x 1in Truss Head Machine Screw (1) #8-32 x 1-1/2in Truss Head Machine Screw	N/A
BP538072G10	Knob	Satin Nickel	1-5/8 (41) DIA	1-5/8 (41)	N/A	1-1/2 (38)	1 L x 1 W (25 L x 25 W)	Zinc	(1) #8-32 x 1in Truss Head Machine Screw (1) #8-32 x 1-1/2in Truss Head Machine Screw	N/A
BP538072ORB	Knob	Oil-Rubbed Bronze	1-5/8 (41) DIA	1-5/8 (41)	N/A	1-1/2 (38)	1 L x 1 W (25 L x 25 W)	Zinc	(1) #8-32 x 1in Truss Head Machine Screw (1) #8-32 x 1-1/2in Truss Head Machine Screw	N/A

Mounting hardware included.  
The dimensional information provided here should be verified with the actual product prior to drilling or attempting to install the hardware.  
Please direct any questions you may have on the installation process to Amerock Customer Service (see back cover for contact information).

# PRODUCT INDEX

Product No.	Type	Finish	Product Detail in (mm)	Length in (mm)	Width in (mm)	Projection in (mm)	Base Dimensions in (mm)	Base Material	Mounting Hardware Included	ADA-Friendly
<b>Kane (continued) • p. 38</b>										
BP538072PN	Knob	Polished Nickel	1-5/8 (41) DIA	1-5/8 (41)	N/A	1-1/2 (38)	1 L x 1 W (25 L x 25 W)	Zinc	(1) #8-32 x 1in Truss Head Machine Screw (1) #8-32 x 1-1/2in Truss Head Machine Screw	N/A
BP538072WN	Knob	Weathered Nickel	1-5/8 (41) DIA	1-5/8 (41)	N/A	1-1/2 (38)	1 L x 1 W (25 L x 25 W)	Zinc	(1) #8-32 x 1in Truss Head Machine Screw (1) #8-32 x 1-1/2in Truss Head Machine Screw	N/A
<b>Candler • p. 40</b>										
BP29340AS	Knob	Antique Silver	1-1/4 (32) LGTH	1-1/4 (32)	1 (25)	1-1/8 (29)	1 L x 3/4 W (25 L x 19 W)	Zinc	(1) #8-32 x 1in Truss Head Machine Screw (1) #8-32 x 1-1/2in Truss Head Machine Screw	N/A
BP29340BBR	Knob	Black Bronze	1-1/4 (32) LGTH	1-1/4 (32)	1 (25)	1-1/8 (29)	1 L x 3/4 W (25 L x 19 W)	Zinc	(1) #8-32 x 1in Truss Head Machine Screw (1) #8-32 x 1-1/2in Truss Head Machine Screw	N/A
BP29340BBZ	Knob	Golden Champagne	1-1/4 (32) LGTH	1-1/4 (32)	1 (25)	1-1/8 (29)	1 L x 3/4 W (25 L x 19 W)	Zinc	(1) #8-32 x 1in Truss Head Machine Screw (1) #8-32 x 1-1/2in Truss Head Machine Screw	N/A
BP29340CBZ	Knob	Caramel Bronze	1-1/4 (32) LGTH	1-1/4 (32)	1 (25)	1-1/8 (29)	1 L x 3/4 W (25 L x 19 W)	Zinc	(1) #8-32 x 1in Truss Head Machine Screw (1) #8-32 x 1-1/2in Truss Head Machine Screw	N/A
BP29340G10	Knob	Satin Nickel	1-1/4 (32) LGTH	1-1/4 (32)	1 (25)	1-1/8 (29)	1 L x 3/4 W (25 L x 19 W)	Zinc	(1) #8-32 x 1in Truss Head Machine Screw (1) #8-32 x 1-1/2in Truss Head Machine Screw	N/A
BP29340GM	Knob	Gunmetal	1-1/4 (32) LGTH	1-1/4 (32)	1 (25)	1-1/8 (29)	1 L x 3/4 W (25 L x 19 W)	Zinc	(1) #8-32 x 1in Truss Head Machine Screw (1) #8-32 x 1-1/2in Truss Head Machine Screw	N/A
BP29340ORB	Knob	Oil-Rubbed Bronze	1-1/4 (32) LGTH	1-1/4 (32)	1 (25)	1-1/8 (29)	1 L x 3/4 W (25 L x 19 W)	Zinc	(1) #8-32 x 1in Truss Head Machine Screw (1) #8-32 x 1-1/2in Truss Head Machine Screw	N/A
BP29340PN	Knob	Polished Nickel	1-1/4 (32) LGTH	1-1/4 (32)	1 (25)	1-1/8 (29)	1 L x 3/4 W (25 L x 19 W)	Zinc	(1) #8-32 x 1in Truss Head Machine Screw (1) #8-32 x 1-1/2in Truss Head Machine Screw	N/A
BP29349AS	Pull	Antique Silver	3 (76) CTC	4-3/8 (111)	3/4 (19)	1-1/8 (29)	7/8 L x 3/4 W (22 L x 19 W)	Zinc	(2) #8-32 x 1in Truss Head Machine Screw (2) #8-32 x 1-1/2in Truss Head Machine Screw	N/A
BP29349BBR	Pull	Black Bronze	3 (76) CTC	4-3/8 (111)	3/4 (19)	1-1/8 (29)	7/8 L x 3/4 W (22 L x 19 W)	Zinc	(2) #8-32 x 1in Truss Head Machine Screw (2) #8-32 x 1-1/2in Truss Head Machine Screw	N/A
BP29349BBZ	Pull	Golden Champagne	3 (76) CTC	4-3/8 (111)	3/4 (19)	1-1/8 (29)	7/8 L x 3/4 W (22 L x 19 W)	Zinc	(2) #8-32 x 1in Truss Head Machine Screw (2) #8-32 x 1-1/2in Truss Head Machine Screw	N/A
BP29349CBZ	Pull	Caramel Bronze	3 (76) CTC	4-3/8 (111)	3/4 (19)	1-1/8 (29)	7/8 L x 3/4 W (22 L x 19 W)	Zinc	(2) #8-32 x 1in Truss Head Machine Screw (2) #8-32 x 1-1/2in Truss Head Machine Screw	N/A
BP29349G10	Pull	Satin Nickel	3 (76) CTC	4-3/8 (111)	3/4 (19)	1-1/8 (29)	7/8 L x 3/4 W (22 L x 19 W)	Zinc	(2) #8-32 x 1in Truss Head Machine Screw (2) #8-32 x 1-1/2in Truss Head Machine Screw	N/A
BP29349GM	Pull	Gunmetal	3 (76) CTC	4-3/8 (111)	3/4 (19)	1-1/8 (29)	7/8 L x 3/4 W (22 L x 19 W)	Zinc	(2) #8-32 x 1in Truss Head Machine Screw (2) #8-32 x 1-1/2in Truss Head Machine Screw	N/A
BP29349ORB	Pull	Oil-Rubbed Bronze	3 (76) CTC	4-3/8 (111)	3/4 (19)	1-1/8 (29)	7/8 L x 3/4 W (22 L x 19 W)	Zinc	(2) #8-32 x 1in Truss Head Machine Screw (2) #8-32 x 1-1/2in Truss Head Machine Screw	N/A
BP29349PN	Pull	Polished Nickel	3 (76) CTC	4-3/8 (111)	3/4 (19)	1-1/8 (29)	7/8 L x 3/4 W (22 L x 19 W)	Zinc	(2) #8-32 x 1in Truss Head Machine Screw (2) #8-32 x 1-1/2in Truss Head Machine Screw	N/A
BP29355AS	Pull	Antique Silver	3-3/4 (96) CTC	5-3/16 (132)	3/4 (19)	1-3/16 (30)	7/8 L x 3/4 W (22 L x 19 W)	Zinc	(2) #8-32 x 1in Truss Head Machine Screw (2) #8-32 x 1-1/2in Truss Head Machine Screw	N/A
BP29355BBR	Pull	Black Bronze	3-3/4 (96) CTC	5-3/16 (132)	3/4 (19)	1-3/16 (30)	7/8 L x 3/4 W (22 L x 19 W)	Zinc	(2) #8-32 x 1in Truss Head Machine Screw (2) #8-32 x 1-1/2in Truss Head Machine Screw	N/A
BP29355BBZ	Pull	Golden Champagne	3-3/4 (96) CTC	5-3/16 (132)	3/4 (19)	1-3/16 (30)	7/8 L x 3/4 W (22 L x 19 W)	Zinc	(2) #8-32 x 1in Truss Head Machine Screw (2) #8-32 x 1-1/2in Truss Head Machine Screw	N/A
BP29355CBZ	Pull	Caramel Bronze	3-3/4 (96) CTC	5-3/16 (132)	3/4 (19)	1-3/16 (30)	7/8 L x 3/4 W (22 L x 19 W)	Zinc	(2) #8-32 x 1in Truss Head Machine Screw (2) #8-32 x 1-1/2in Truss Head Machine Screw	N/A
BP29355G10	Pull	Satin Nickel	3-3/4 (96) CTC	5-3/16 (132)	3/4 (19)	1-3/16 (30)	7/8 L x 3/4 W (22 L x 19 W)	Zinc	(2) #8-32 x 1in Truss Head Machine Screw (2) #8-32 x 1-1/2in Truss Head Machine Screw	N/A
BP29355GM	Pull	Gunmetal	3-3/4 (96) CTC	5-3/16 (132)	3/4 (19)	1-3/16 (30)	7/8 L x 3/4 W (22 L x 19 W)	Zinc	(2) #8-32 x 1in Truss Head Machine Screw (2) #8-32 x 1-1/2in Truss Head Machine Screw	N/A

Mounting hardware included.  
The dimensional information provided here should be verified with the actual product prior to drilling or attempting to install the hardware.  
Please direct any questions you may have on the installation process to Amerock Customer Service (see back cover for contact information).

# PRODUCT INDEX

Product No.	Type	Finish	Product Detail in (mm)	Length in (mm)	Width in (mm)	Projection in (mm)	Base Dimensions in (mm)	Base Material	Mounting Hardware Included	ADA-Friendly
<b>Candler (continued) • p. 40</b>										
BP29355ORB	Pull	Oil-Rubbed Bronze	3-3/4 (96) CTC	5-3/16 (132)	3/4 (19)	1-3/16 (30)	7/8 L x 3/4 W (22 L x 19 W)	Zinc	(2) #8-32 x 1in Truss Head Machine Screw (2) #8-32 x 1-1/2in Truss Head Machine Screw	N/A
BP29355PN	Pull	Polished Nickel	3-3/4 (96) CTC	5-3/16 (132)	3/4 (19)	1-3/16 (30)	7/8 L x 3/4 W (22 L x 19 W)	Zinc	(2) #8-32 x 1in Truss Head Machine Screw (2) #8-32 x 1-1/2in Truss Head Machine Screw	N/A
BP29355VB	Pull	Venetian Bronze	3-3/4 (96) CTC	5-3/16 (132)	3/4 (19)	1-3/16 (30)	7/8 L x 3/4 W (22 L x 19 W)	Zinc	(2) #8-32 x 1in Truss Head Machine Screw (2) #8-32 x 1-1/2in Truss Head Machine Screw	N/A
BP29363AS	Pull	Antique Silver	5-1/16 (128) CTC	6-9/16 (167)	13/16 (21)	1-1/4 (32)	1 L x 13/16 W (25 L x 21 W)	Zinc	(2) #8-32 x 1in Truss Head Machine Screw (2) #8-32 x 1-1/2in Truss Head Machine Screw	✓
BP29363BBR	Pull	Black Bronze	5-1/16 (128) CTC	6-9/16 (167)	13/16 (21)	1-1/4 (32)	1 L x 13/16 W (25 L x 21 W)	Zinc	(2) #8-32 x 1in Truss Head Machine Screw (2) #8-32 x 1-1/2in Truss Head Machine Screw	✓
BP29363BBZ	Pull	Golden Champagne	5-1/16 (128) CTC	6-9/16 (167)	13/16 (21)	1-1/4 (32)	1 L x 13/16 W (25 L x 21 W)	Zinc	(2) #8-32 x 1in Truss Head Machine Screw (2) #8-32 x 1-1/2in Truss Head Machine Screw	✓
BP29363G10	Pull	Satin Nickel	5-1/16 (128) CTC	6-9/16 (167)	13/16 (21)	1-1/4 (32)	1 L x 13/16 W (25 L x 21 W)	Zinc	(2) #8-32 x 1in Truss Head Machine Screw (2) #8-32 x 1-1/2in Truss Head Machine Screw	✓
BP29363GM	Pull	Gunmetal	5-1/16 (128) CTC	6-9/16 (167)	13/16 (21)	1-1/4 (32)	1 L x 13/16 W (25 L x 21 W)	Zinc	(2) #8-32 x 1in Truss Head Machine Screw (2) #8-32 x 1-1/2in Truss Head Machine Screw	✓
BP29363ORB	Pull	Oil-Rubbed Bronze	5-1/16 (128) CTC	6-9/16 (167)	13/16 (21)	1-1/4 (32)	1 L x 13/16 W (25 L x 21 W)	Zinc	(2) #8-32 x 1in Truss Head Machine Screw (2) #8-32 x 1-1/2in Truss Head Machine Screw	✓
BP29363PN	Pull	Polished Nickel	5-1/16 (128) CTC	6-9/16 (167)	13/16 (21)	1-1/4 (32)	1 L x 13/16 W (25 L x 21 W)	Zinc	(2) #8-32 x 1in Truss Head Machine Screw (2) #8-32 x 1-1/2in Truss Head Machine Screw	✓
BP29364AS	Pull	Antique Silver	6-5/16 (160) CTC	7-15/16 (202)	15/16 (24)	1-5/16 (33)	1-1/8 L x 15/16 W (29 L x 24 W)	Zinc	(2) #8-32 x 1in Truss Head Machine Screw (2) #8-32 x 1-1/2in Truss Head Machine Screw	✓
BP29364BBR	Pull	Black Bronze	6-5/16 (160) CTC	7-15/16 (202)	15/16 (24)	1-5/16 (33)	1-1/8 L x 15/16 W (29 L x 24 W)	Zinc	(2) #8-32 x 1in Truss Head Machine Screw (2) #8-32 x 1-1/2in Truss Head Machine Screw	✓
BP29364BBZ	Pull	Golden Champagne	6-5/16 (160) CTC	7-15/16 (202)	15/16 (24)	1-5/16 (33)	1-1/8 L x 15/16 W (29 L x 24 W)	Zinc	(2) #8-32 x 1in Truss Head Machine Screw (2) #8-32 x 1-1/2in Truss Head Machine Screw	✓
BP29364G10	Pull	Satin Nickel	6-5/16 (160) CTC	7-15/16 (202)	15/16 (24)	1-5/16 (33)	1-1/8 L x 15/16 W (29 L x 24 W)	Zinc	(2) #8-32 x 1in Truss Head Machine Screw (2) #8-32 x 1-1/2in Truss Head Machine Screw	✓
BP29364GM	Pull	Gunmetal	6-5/16 (160) CTC	7-15/16 (202)	15/16 (24)	1-5/16 (33)	1-1/8 L x 15/16 W (29 L x 24 W)	Zinc	(2) #8-32 x 1in Truss Head Machine Screw (2) #8-32 x 1-1/2in Truss Head Machine Screw	✓
BP29364ORB	Pull	Oil-Rubbed Bronze	6-5/16 (160) CTC	7-15/16 (202)	15/16 (24)	1-5/16 (33)	1-1/8 L x 15/16 W (29 L x 24 W)	Zinc	(2) #8-32 x 1in Truss Head Machine Screw (2) #8-32 x 1-1/2in Truss Head Machine Screw	✓
BP29364PN	Pull	Polished Nickel	6-5/16 (160) CTC	7-15/16 (202)	15/16 (24)	1-5/16 (33)	1-1/8 L x 15/16 W (29 L x 24 W)	Zinc	(2) #8-32 x 1in Truss Head Machine Screw (2) #8-32 x 1-1/2in Truss Head Machine Screw	✓
BP29365AS	Appliance Pull	Antique Silver	8 (203) CTC	10-1/4 (260)	1-1/8 (29)	1-5/16 (33)	4-1/16 L x 1-1/4 W (103 L x 32 W)	Zinc	(2) #10-24 x 3/4in Pan Head Machine Screw (2) #10-24 x 1in Pan Head Machine Screw (2) #10-24 x 1-1/4in Pan Head Machine Screw (2) #10-24 x 1-1/2in Pan Head Machine Screw (2) #10-24 x 1-3/4in Pan Head Machine Screw	✓
BP29365BBR	Appliance Pull	Black Bronze	8 (203) CTC	10-1/4 (260)	1-1/8 (29)	1-5/16 (33)	4-1/16 L x 1-1/4 W (103 L x 32 W)	Zinc	(2) #10-24 x 3/4in Pan Head Machine Screw (2) #10-24 x 1in Pan Head Machine Screw (2) #10-24 x 1-1/4in Pan Head Machine Screw (2) #10-24 x 1-1/2in Pan Head Machine Screw (2) #10-24 x 1-3/4in Pan Head Machine Screw	✓
BP29365BBZ	Appliance Pull	Golden Champagne	8 (203) CTC	10-1/4 (260)	1-1/8 (29)	1-5/16 (33)	4-1/16 L x 1-1/4 W (103 L x 32 W)	Zinc	(2) #10-24 x 3/4in Pan Head Machine Screw (2) #10-24 x 1in Pan Head Machine Screw (2) #10-24 x 1-1/4in Pan Head Machine Screw (2) #10-24 x 1-1/2in Pan Head Machine Screw (2) #10-24 x 1-3/4in Pan Head Machine Screw	✓
BP29365G10	Appliance Pull	Satin Nickel	8 (203) CTC	10-1/4 (260)	1-1/8 (29)	1-5/16 (33)	4-1/16 L x 1-1/4 W (103 L x 32 W)	Zinc	(2) #10-24 x 3/4in Pan Head Machine Screw (2) #10-24 x 1in Pan Head Machine Screw (2) #10-24 x 1-1/4in Pan Head Machine Screw (2) #10-24 x 1-1/2in Pan Head Machine Screw (2) #10-24 x 1-3/4in Pan Head Machine Screw	✓

Mounting hardware included.  
The dimensional information provided here should be verified with the actual product prior to drilling or attempting to install the hardware.  
Please direct any questions you may have on the installation process to Amerock Customer Service (see back cover for contact information).

# PRODUCT INDEX

Product No.	Type	Finish	Product Detail in (mm)	Length in (mm)	Width in (mm)	Projection in (mm)	Base Dimensions in (mm)	Base Material	Mounting Hardware Included	ADA-Friendly
<b>Candler (continued) • p. 40</b>										
BP29365ORB	Appliance Pull	Oil-Rubbed Bronze	8 (203) CTC	10-1/4 (260)	1-1/8 (29)	1-5/16 (33)	4-1/16 L x 1-1/4 W (103 L x 32 W)	Zinc	(2) #10-24 x 3/4in Pan Head Machine Screw (2) #10-24 x 1in Pan Head Machine Screw (2) #10-24 x 1-1/4in Pan Head Machine Screw (2) #10-24 x 1-1/2in Pan Head Machine Screw (2) #10-24 x 1-3/4in Pan Head Machine Screw	✓
BP29365PN	Appliance Pull	Polished Nickel	8 (203) CTC	10-1/4 (260)	1-1/8 (29)	1-5/16 (33)	4-1/16 L x 1-1/4 W (103 L x 32 W)	Zinc	(2) #10-24 x 3/4in Pan Head Machine Screw (2) #10-24 x 1in Pan Head Machine Screw (2) #10-24 x 1-1/4in Pan Head Machine Screw (2) #10-24 x 1-1/2in Pan Head Machine Screw (2) #10-24 x 1-3/4in Pan Head Machine Screw	✓
BP29366AS	Appliance Pull	Antique Silver	12 (305) CTC	14-7/16 (367)	1-3/8 (35)	1-13/16 (46)	1-5/8 L x 1-3/8 W (41 L x 35 W)	Zinc	(2) #10-24 x 3/4in Pan Head Machine Screw (2) #10-24 x 1in Pan Head Machine Screw (2) #10-24 x 1-1/4in Pan Head Machine Screw (2) #10-24 x 1-1/2in Pan Head Machine Screw (2) #10-24 x 1-3/4in Pan Head Machine Screw	✓
BP29366BBR	Appliance Pull	Black Bronze	12 (305) CTC	14-7/16 (367)	1-3/8 (35)	1-13/16 (46)	1-5/8 L x 1-3/8 W (41 L x 35 W)	Zinc	(2) #10-24 x 3/4in Pan Head Machine Screw (2) #10-24 x 1in Pan Head Machine Screw (2) #10-24 x 1-1/4in Pan Head Machine Screw (2) #10-24 x 1-1/2in Pan Head Machine Screw (2) #10-24 x 1-3/4in Pan Head Machine Screw	✓
BP29366BBZ	Appliance Pull	Golden Champagne	12 (305) CTC	14-7/16 (367)	1-3/8 (35)	1-13/16 (46)	1-5/8 L x 1-3/8 W (41 L x 35 W)	Zinc	(2) #10-24 x 3/4in Pan Head Machine Screw (2) #10-24 x 1in Pan Head Machine Screw (2) #10-24 x 1-1/4in Pan Head Machine Screw (2) #10-24 x 1-1/2in Pan Head Machine Screw (2) #10-24 x 1-3/4in Pan Head Machine Screw	✓
BP29366G10	Appliance Pull	Satin Nickel	12 (305) CTC	14-7/16 (367)	1-3/8 (35)	1-13/16 (46)	1-5/8 L x 1-3/8 W (41 L x 35 W)	Zinc	(2) #10-24 x 3/4in Pan Head Machine Screw (2) #10-24 x 1in Pan Head Machine Screw (2) #10-24 x 1-1/4in Pan Head Machine Screw (2) #10-24 x 1-1/2in Pan Head Machine Screw (2) #10-24 x 1-3/4in Pan Head Machine Screw	✓
BP29366ORB	Appliance Pull	Oil-Rubbed Bronze	12 (305) CTC	14-7/16 (367)	1-3/8 (35)	1-13/16 (46)	1-5/8 L x 1-3/8 W (41 L x 35 W)	Zinc	(2) #10-24 x 3/4in Pan Head Machine Screw (2) #10-24 x 1in Pan Head Machine Screw (2) #10-24 x 1-1/4in Pan Head Machine Screw (2) #10-24 x 1-1/2in Pan Head Machine Screw (2) #10-24 x 1-3/4in Pan Head Machine Screw	✓
BP29366PN	Appliance Pull	Polished Nickel	12 (305) CTC	14-7/16 (367)	1-3/8 (35)	1-13/16 (46)	1-5/8 L x 1-3/8 W (41 L x 35 W)	Zinc	(2) #10-24 x 3/4in Pan Head Machine Screw (2) #10-24 x 1in Pan Head Machine Screw (2) #10-24 x 1-1/4in Pan Head Machine Screw (2) #10-24 x 1-1/2in Pan Head Machine Screw (2) #10-24 x 1-3/4in Pan Head Machine Screw	✓
BP29367AS	Appliance Pull	Antique Silver	18 (457) CTC	20-3/4 (527)	1-9/16 (40)	2-1/16 (52)	1-15/16 L x 1-9/16 W (49 L x 40 W)	Zinc	(2) #10-24 x 3/4in Pan Head Machine Screw (2) #10-24 x 1in Pan Head Machine Screw (2) #10-24 x 1-1/4in Pan Head Machine Screw (2) #10-24 x 1-1/2in Pan Head Machine Screw (2) #10-24 x 1-3/4in Pan Head Machine Screw	✓
BP29367BBR	Appliance Pull	Black Bronze	18 (457) CTC	20-3/4 (527)	1-3/8 (35)	2-1/16 (52)	1-15/16 L x 1-9/16 W (49 L x 40 W)	Zinc	(2) #10-24 x 3/4in Pan Head Machine Screw (2) #10-24 x 1in Pan Head Machine Screw (2) #10-24 x 1-1/4in Pan Head Machine Screw (2) #10-24 x 1-1/2in Pan Head Machine Screw (2) #10-24 x 1-3/4in Pan Head Machine Screw	✓
BP29367BBZ	Appliance Pull	Golden Champagne	18 (457) CTC	20-3/4 (527)	1-3/8 (35)	2-1/16 (52)	1-15/16 L x 1-9/16 W (49 L x 40 W)	Zinc	(2) #10-24 x 3/4in Pan Head Machine Screw (2) #10-24 x 1in Pan Head Machine Screw (2) #10-24 x 1-1/4in Pan Head Machine Screw (2) #10-24 x 1-1/2in Pan Head Machine Screw (2) #10-24 x 1-3/4in Pan Head Machine Screw	✓
BP29367G10	Appliance Pull	Satin Nickel	18 (457) CTC	20-3/4 (527)	1-9/16 (40)	2-1/16 (52)	1-15/16 L x 1-9/16 W (49 L x 40 W)	Zinc	(2) #10-24 x 3/4in Pan Head Machine Screw (2) #10-24 x 1in Pan Head Machine Screw (2) #10-24 x 1-1/4in Pan Head Machine Screw (2) #10-24 x 1-1/2in Pan Head Machine Screw (2) #10-24 x 1-3/4in Pan Head Machine Screw	✓

Mounting hardware included.

The dimensional information provided here should be verified with the actual product prior to drilling or attempting to install the hardware. Please direct any questions you may have on the installation process to Amerock Customer Service (see back cover for contact information).

# PRODUCT INDEX

Product No.	Type	Finish	Product Detail in (mm)	Length in (mm)	Width in (mm)	Projection in (mm)	Base Dimensions in (mm)	Base Material	Mounting Hardware Included	ADA-Friendly
<b>Candler (continued) • p. 40</b>										
BP29367ORB	Appliance Pull	Oil-Rubbed Bronze	18 (457) CTC	20-3/4 (527)	1-9/16 (40)	2-1/16 (52)	1-15/16 L x 1-9/16 W (49 L x 40 W)	Zinc	(2) #10-24 x 3/4in Pan Head Machine Screw (2) #10-24 x 1in Pan Head Machine Screw (2) #10-24 x 1-1/4in Pan Head Machine Screw (2) #10-24 x 1-1/2in Pan Head Machine Screw (2) #10-24 x 1-3/4in Pan Head Machine Screw	✓
BP29367PN	Appliance Pull	Polished Nickel	18 (457) CTC	20-3/4 (527)	1-3/8 (35)	2-1/16 (52)	1-15/16 L x 1-9/16 W (49 L x 40 W)	Zinc	(2) #10-24 x 3/4in Pan Head Machine Screw (2) #10-24 x 1in Pan Head Machine Screw (2) #10-24 x 1-1/4in Pan Head Machine Screw (2) #10-24 x 1-1/2in Pan Head Machine Screw (2) #10-24 x 1-3/4in Pan Head Machine Screw	✓
BP29368AS	Knob	Antique Silver	1-1/2 (38) LGTH	1-1/2 (38)	1-1/4 (32)	1-1/4 (32)	1 L x 3/4 W (25 L x 19 W)	Zinc	(1) #8-32 x 1in Truss Head Machine Screw (1) #8-32 x 1-1/2in Truss Head Machine Screw	N/A
BP29368BBR	Knob	Black Bronze	1-1/2 (38) LGTH	1-1/2 (38)	1-1/4 (32)	1-1/4 (32)	1 L x 3/4 W (25 L x 19 W)	Zinc	(1) #8-32 x 1in Truss Head Machine Screw (1) #8-32 x 1-1/2in Truss Head Machine Screw	N/A
BP29368BBZ	Knob	Golden Champagne	1-1/2 (38) LGTH	1-1/2 (38)	1-1/4 (32)	1-1/4 (32)	1 L x 3/4 W (25 L x 19 W)	Zinc	(1) #8-32 x 1in Truss Head Machine Screw (1) #8-32 x 1-1/2in Truss Head Machine Screw	N/A
BP29368G10	Knob	Satin Nickel	1-1/2 (38) LGTH	1-1/2 (38)	1-1/4 (32)	1-1/4 (32)	1 L x 3/4 W (25 L x 19 W)	Zinc	(1) #8-32 x 1in Truss Head Machine Screw (1) #8-32 x 1-1/2in Truss Head Machine Screw	N/A
BP29368GM	Knob	Gunmetal	1-1/2 (38) LGTH	1-1/2 (38)	1-1/4 (32)	1-1/4 (32)	1 L x 3/4 W (25 L x 19 W)	Zinc	(1) #8-32 x 1in Truss Head Machine Screw (1) #8-32 x 1-1/2in Truss Head Machine Screw	N/A
BP29368ORB	Knob	Oil-Rubbed Bronze	1-1/2 (38) LGTH	1-1/2 (38)	1-1/4 (32)	1-1/4 (32)	1 L x 3/4 W (25 L x 19 W)	Zinc	(1) #8-32 x 1in Truss Head Machine Screw (1) #8-32 x 1-1/2in Truss Head Machine Screw	N/A
BP29368PN	Knob	Polished Nickel	1-1/2 (38) LGTH	1-1/2 (38)	1-1/4 (32)	1-1/4 (32)	1 L x 3/4 W (25 L x 19 W)	Zinc	(1) #8-32 x 1in Truss Head Machine Screw (1) #8-32 x 1-1/2in Truss Head Machine Screw	N/A
<b>Rochdale • p. 42</b>										
BP53710G10	Knob	Satin Nickel	1-1/4 (32) DIA	1-1/4 (32)	N/A	1-1/8 (29)	1-1/16 L x 1-1/16 W (27 L x 27 W)	Zinc	(1) #8-32 x 1in Truss Head Machine Screw (1) #8-32 x 1-1/2in Truss Head Machine Screw	N/A
BP53710GPH	Knob	Graphite	1-1/4 (32) DIA	1-1/4 (32)	N/A	1-1/8 (29)	1-1/16 L x 1-1/16 W (27 L x 27 W)	Zinc	(1) #8-32 x 1in Truss Head Machine Screw (1) #8-32 x 1-1/2in Truss Head Machine Screw	N/A
BP53711G10	Pull	Satin Nickel	3 (76) CTC	4 (102)	1-1/16 (27)	1-3/16 (30)	1-1/16 L x 11/16 W (27 L x 17 W)	Zinc	(2) #8-32 x 1in Truss Head Machine Screw (2) #8-32 x 1-1/2in Truss Head Machine Screw	N/A
BP53711GPH	Pull	Graphite	3 (76) CTC	4 (102)	1-1/16 (27)	1-3/16 (30)	1-1/16 L x 11/16 W (27 L x 17 W)	Zinc	(2) #8-32 x 1in Truss Head Machine Screw (2) #8-32 x 1-1/2in Truss Head Machine Screw	N/A
BP53712G10	Pull	Satin Nickel	3-3/4 (96) CTC	4-3/4 (121)	1-1/16 (27)	1-3/16 (30)	1 L x 11/16 W (25 L x 17 W)	Zinc	(2) #8-32 x 1in Truss Head Machine Screw (2) #8-32 x 1-1/2in Truss Head Machine Screw	✓
BP53712GPH	Pull	Graphite	3-3/4 (96) CTC	4-3/4 (121)	1-1/16 (27)	1-3/16 (30)	1 L x 11/16 W (25 L x 17 W)	Zinc	(2) #8-32 x 1in Truss Head Machine Screw (2) #8-32 x 1-1/2in Truss Head Machine Screw	✓
BP53713G10	Pull	Satin Nickel	5-1/16 (128) CTC	6-1/16 (154)	1-1/16 (27)	1-1/4 (32)	1-1/16 L x 11/16 W (27 L x 17 W)	Zinc	(2) #8-32 x 1in Truss Head Machine Screw (2) #8-32 x 1-1/2in Truss Head Machine Screw	✓
BP53713GPH	Pull	Graphite	5-1/16 (128) CTC	6-1/16 (154)	1-1/16 (27)	1-1/4 (32)	1-1/16 L x 11/16 W (27 L x 17 W)	Zinc	(2) #8-32 x 1in Truss Head Machine Screw (2) #8-32 x 1-1/2in Truss Head Machine Screw	✓
BP53714G10	Pull	Satin Nickel	6-5/16 (160) CTC	7-5/16 (186)	1-1/16 (27)	1-5/16 (33)	1 L x 11/16 W (25 L x 17 W)	Zinc	(2) #8-32 x 1in Truss Head Machine Screw (2) #8-32 x 1-1/2in Truss Head Machine Screw	✓
BP53714GPH	Pull	Graphite	6-5/16 (160) CTC	7-5/16 (186)	1-1/16 (27)	1-5/16 (33)	1 L x 11/16 W (25 L x 17 W)	Zinc	(2) #8-32 x 1in Truss Head Machine Screw (2) #8-32 x 1-1/2in Truss Head Machine Screw	✓
BP53715G10	Cup Pull	Satin Nickel	3 (76) CTC	4-1/2 (114)	7/8 (22)	13/16 (21)	4-1/2 L x 7/8 W (114 L x 22 W)	Zinc	(2) #8-32 x 1in Truss Head Machine Screw (2) #8-32 x 1-1/2in Truss Head Machine Screw	N/A
BP53715GPH	Cup Pull	Graphite	3 (76) CTC	4-1/2 (114)	7/8 (22)	13/16 (21)	4-1/2 L x 7/8 W (114 L x 22 W)	Zinc	(2) #8-32 x 1in Truss Head Machine Screw (2) #8-32 x 1-1/2in Truss Head Machine Screw	N/A

Mounting hardware included.  
The dimensional information provided here should be verified with the actual product prior to drilling or attempting to install the hardware.  
Please direct any questions you may have on the installation process to Amerock Customer Service (see back cover for contact information).

# PRODUCT INDEX

Product No.	Type	Finish	Product Detail in (mm)	Length in (mm)	Width in (mm)	Projection in (mm)	Base Dimensions in (mm)	Base Material	Mounting Hardware Included	ADA-Friendly
<b>Rochdale (continued) • p. 42</b>										
BP53716G10	Cup Pull	Satin Nickel	3-3/4 (96) CTC	5-5/16 (135)	7/8 (22)	13/16 (21)	5-5/16 L x 7/8 W (135 L x 22 W)	Zinc	(2) #8-32 x 1in Truss Head Machine Screw (2) #8-32 x 1-1/2in Truss Head Machine Screw	N/A
BP53716GPH	Cup Pull	Graphite	3-3/4 (96) CTC	5-5/16 (135)	7/8 (22)	13/16 (21)	5-5/16 L x 7/8 W (135 L x 22 W)	Zinc	(2) #8-32 x 1in Truss Head Machine Screw (2) #8-32 x 1-1/2in Truss Head Machine Screw	N/A
<b>Glacio • p. 46</b>										
BH36060C26	Robe Hook	Clear/Chrome	Single	2-15/16 (75)	1-7/8 (48)	2-1/2 (64)	1-7/8 L x 1-7/8 W (48 L x 48 W)	Zinc/Acrylic	(2) #8 x 1-1/4 in. Sheet Metal Screw (1) Mounting Bracket	N/A
BH36060CBBZ	Robe Hook	Clear/ Golden Champagne	Single	2-15/16 (75)	1-7/8 (48)	2-1/2 (64)	1-7/8 L x 1-7/8 W (48 L x 48 W)	Zinc/Acrylic	(2) #8 x 1-1/4 in. Sheet Metal Screw (1) Mounting Bracket	N/A
BH36060CCZ	Robe Hook	Clear/ Champagne Bronze	Single	2-15/16 (75)	1-7/8 (48)	2-1/2 (64)	1-7/8 L x 1-7/8 W (48 L x 48 W)	Zinc/Acrylic	(2) #8 x 1-1/4 in. Sheet Metal Screw (1) Mounting Bracket	N/A
BH36060CG10	Robe Hook	Clear/Brushed Nickel	Single	2-15/16 (75)	1-7/8 (48)	2-1/2 (64)	1-7/8 L x 1-7/8 W (48 L x 48 W)	Zinc/Acrylic	(2) #8 x 1-1/4 in. Sheet Metal Screw (1) Mounting Bracket	N/A
BH36060CMB	Robe Hook	Clear/Matte Black	Single	2-15/16 (75)	1-7/8 (48)	2-1/2 (64)	1-7/8 L x 1-7/8 W (48 L x 48 W)	Zinc/Acrylic	(2) #8 x 1-1/4 in. Sheet Metal Screw (1) Mounting Bracket	N/A
BH36060CORB	Robe Hook	Clear/ Oil-Rubbed Bronze	Single	2-15/16 (75)	1-7/8 (48)	2-1/2 (64)	1-7/8 L x 1-7/8 W (48 L x 48 W)	Zinc/Acrylic	(2) #8 x 1-1/4 in. Sheet Metal Screw (1) Mounting Bracket	N/A
BP36651C26	Knob	Clear/ Polished Chrome	1-3/4 (44) LGTH	1-3/4 (44)	1 (25)	1-3/16 (30)	9/16 L x 9/16 W (14 L x 14 W)	Zinc/Glass	(1) #8-32 x 1/2in Truss Head Machine Screw (1) #8-32 x 1in Truss Head Machine Screw	N/A
BP36651CBBR	Knob	Clear/Black Bronze	1-3/4 (44) LGTH	1-3/4 (44)	1 (25)	1-3/16 (30)	9/16 L x 9/16 W (14 L x 14 W)	Zinc/Glass	(1) #8-32 x 1/2in Truss Head Machine Screw (1) #8-32 x 1in Truss Head Machine Screw	N/A
BP36651CBBZ	Knob	Clear/ Golden Champagne	1-3/4 (44) LGTH	1-3/4 (44)	1 (25)	1-3/16 (30)	9/16 L x 9/16 W (14 L x 14 W)	Zinc/Glass	(1) #8-32 x 1/2in Truss Head Machine Screw (1) #8-32 x 1in Truss Head Machine Screw	N/A
BP36651CCZ	Knob	Clear/ Champagne Bronze	1-3/4 (44) LGTH	1-3/4 (44)	1 (25)	1-3/16 (30)	9/16 L x 9/16 W (14 L x 14 W)	Zinc/Glass	(1) #8-32 x 1/2in Truss Head Machine Screw (1) #8-32 x 1in Truss Head Machine Screw	N/A
BP36651CG10	Knob	Clear/Satin Nickel	1-3/4 (44) LGTH	1-3/4 (44)	1 (25)	1-3/16 (30)	9/16 L x 9/16 W (14 L x 14 W)	Zinc/Glass	(1) #8-32 x 1/2in Truss Head Machine Screw (1) #8-32 x 1in Truss Head Machine Screw	N/A
BP36651CGM	Knob	Clear/Gunmetal	1-3/4 (44) LGTH	1-3/4 (44)	1 (25)	1-3/16 (30)	9/16 L x 9/16 W (14 L x 14 W)	Zinc/Glass	(1) #8-32 x 1/2in Truss Head Machine Screw (1) #8-32 x 1in Truss Head Machine Screw	N/A
BP36651CORB	Knob	Clear/ Oil-Rubbed Bronze	1-3/4 (44) LGTH	1-3/4 (44)	1 (25)	1-3/16 (30)	9/16 L x 9/16 W (14 L x 14 W)	Zinc/Glass	(1) #8-32 x 1/2in Truss Head Machine Screw (1) #8-32 x 1in Truss Head Machine Screw	N/A
BP36651CPN	Knob	Clear/Polished Nickel	1-3/4 (44) LGTH	1-3/4 (44)	1 (25)	1-3/16 (30)	9/16 L x 9/16 W (14 L x 14 W)	Zinc/Glass	(1) #8-32 x 1/2in Truss Head Machine Screw (1) #8-32 x 1in Truss Head Machine Screw	N/A
BP36652C26	Knob	Clear/ Polished Chrome	1-3/4 (44) DIA	1-3/4 (44)	N/A	1 (25)	3/4 L x 3/4 W (19 L x 19 W)	Zinc/Glass	(1) #8-32 x 1/2in Truss Head Machine Screw (1) #8-32 x 1in Truss Head Machine Screw	N/A
BP36652CBBR	Knob	Clear/Black Bronze	1-3/4 (44) DIA	1-3/4 (44)	N/A	1 (25)	3/4 L x 3/4 W (19 L x 19 W)	Zinc/Glass	(1) #8-32 x 1/2in Truss Head Machine Screw (1) #8-32 x 1in Truss Head Machine Screw	N/A
BP36652CBBZ	Knob	Clear/ Golden Champagne	1-3/4 (44) DIA	1-3/4 (44)	N/A	1 (25)	3/4 L x 3/4 W (19 L x 19 W)	Zinc/Glass	(1) #8-32 x 1/2in Truss Head Machine Screw (1) #8-32 x 1in Truss Head Machine Screw	N/A
BP36652CCZ	Knob	Clear/ Champagne Bronze	1-3/4 (44) DIA	1-3/4 (44)	N/A	1 (25)	3/4 L x 3/4 W (19 L x 19 W)	Zinc/Glass	(1) #8-32 x 1/2in Truss Head Machine Screw (1) #8-32 x 1in Truss Head Machine Screw	N/A
BP36652CG10	Knob	Clear/Satin Nickel	1-3/4 (44) DIA	1-3/4 (44)	N/A	1 (25)	3/4 L x 3/4 W (19 L x 19 W)	Zinc/Glass	(1) #8-32 x 1/2in Truss Head Machine Screw (1) #8-32 x 1in Truss Head Machine Screw	N/A
BP36652CGM	Knob	Clear/Gunmetal	1-3/4 (44) DIA	1-3/4 (44)	N/A	1 (25)	3/4 L x 3/4 W (19 L x 19 W)	Zinc/Glass	(1) #8-32 x 1/2in Truss Head Machine Screw (1) #8-32 x 1in Truss Head Machine Screw	N/A
BP36652CORB	Knob	Clear/ Oil-Rubbed Bronze	1-3/4 (44) DIA	1-3/4 (44)	N/A	1 (25)	3/4 L x 3/4 W (19 L x 19 W)	Zinc/Glass	(1) #8-32 x 1/2in Truss Head Machine Screw (1) #8-32 x 1in Truss Head Machine Screw	N/A
BP36652CPN	Knob	Clear/Polished Nickel	1-3/4 (44) DIA	1-3/4 (44)	N/A	1 (25)	3/4 L x 3/4 W (19 L x 19 W)	Zinc/Glass	(1) #8-32 x 1/2in Truss Head Machine Screw (1) #8-32 x 1in Truss Head Machine Screw	N/A

Mounting hardware included.  
The dimensional information provided here should be verified with the actual product prior to drilling or attempting to install the hardware.  
Please direct any questions you may have on the installation process to Amerock Customer Service (see back cover for contact information).

# PRODUCT INDEX

Product No.	Type	Finish	Product Detail in (mm)	Length in (mm)	Width in (mm)	Projection in (mm)	Base Dimensions in (mm)	Base Material	Mounting Hardware Included	ADA-Friendly
Glacio (continued) • p. 46										
BP36653C26	Knob	Clear/Polished Chrome	1-3/8 (35) LGTH	1-3/8 (35)	1-3/8 (35)	1-5/16 (33)	3/4 L x 3/4 W (19 L x 19 W)	Zinc/Glass	(1) #8-32 x 1/2in Truss Head Machine Screw (1) #8-32 x 1in Truss Head Machine Screw	N/A
BP36653CBBR	Knob	Clear/Black Bronze	1-3/8 (35) LGTH	1-3/8 (35)	1-3/8 (35)	1-5/16 (33)	3/4 L x 3/4 W (19 L x 19 W)	Zinc/Glass	(1) #8-32 x 1/2in Truss Head Machine Screw (1) #8-32 x 1in Truss Head Machine Screw	N/A
BP36653CBBZ	Knob	Clear/Golden Champagne	1-3/8 (35) LGTH	1-3/8 (35)	1-3/8 (35)	1-5/16 (33)	3/4 L x 3/4 W (19 L x 19 W)	Zinc/Glass	(1) #8-32 x 1/2in Truss Head Machine Screw (1) #8-32 x 1in Truss Head Machine Screw	N/A
BP36653CCZ	Knob	Clear/Champagne Bronze	1-3/8 (35) LGTH	1-3/8 (35)	1-3/8 (35)	1-5/16 (33)	3/4 L x 3/4 W (19 L x 19 W)	Zinc/Glass	(1) #8-32 x 1/2in Truss Head Machine Screw (1) #8-32 x 1in Truss Head Machine Screw	N/A
BP36653CG10	Knob	Clear/Satin Nickel	1-3/8 (35) LGTH	1-3/8 (35)	1-3/8 (35)	1-5/16 (33)	3/4 L x 3/4 W (19 L x 19 W)	Zinc/Glass	(1) #8-32 x 1/2in Truss Head Machine Screw (1) #8-32 x 1in Truss Head Machine Screw	N/A
BP36653CGM	Knob	Clear/Gunmetal	1-3/8 (35) LGTH	1-3/8 (35)	1-3/8 (35)	1-5/16 (33)	3/4 L x 3/4 W (19 L x 19 W)	Zinc/Glass	(1) #8-32 x 1/2in Truss Head Machine Screw (1) #8-32 x 1in Truss Head Machine Screw	N/A
BP36653CORB	Knob	Clear/Oil-Rubbed Bronze	1-3/8 (35) LGTH	1-3/8 (35)	1-3/8 (35)	1-5/16 (33)	3/4 L x 3/4 W (19 L x 19 W)	Zinc/Glass	(1) #8-32 x 1/2in Truss Head Machine Screw (1) #8-32 x 1in Truss Head Machine Screw	N/A
BP36653CPN	Knob	Clear/Polished Nickel	1-3/8 (35) LGTH	1-3/8 (35)	1-3/8 (35)	1-5/16 (33)	3/4 L x 3/4 W (19 L x 19 W)	Zinc/Glass	(1) #8-32 x 1/2in Truss Head Machine Screw (1) #8-32 x 1in Truss Head Machine Screw	N/A
BP36654C26	Pull	Clear/Polished Chrome	3-3/4 (96) CTC	5-5/16 (135)	3/4 (19)	1-1/2 (38)	5/8 L x 5/8 W (16 L x 16 W)	Zinc/Glass	(2) #8-s32 x 1in Truss Head Machine Screw (2) #8-32 x 1-1/2in Truss Head Machine Screw	N/A
BP36654CBBR	Pull	Clear/Black Bronze	3-3/4 (96) CTC	5-5/16 (135)	3/4 (19)	1-1/2 (38)	5/8 L x 5/8 W (16 L x 16 W)	Zinc/Glass	(2) #8-32 x 1in Truss Head Machine Screw (2) #8-32 x 1-1/2in Truss Head Machine Screw	N/A
BP36654CBBZ	Pull	Clear/Golden Champagne	3-3/4 (96) CTC	5-5/16 (135)	3/4 (19)	1-1/2 (38)	5/8 L x 5/8 W (16 L x 16 W)	Zinc/Glass	(2) #8-32 x 1in Truss Head Machine Screw (2) #8-32 x 1-1/2in Truss Head Machine Screw	N/A
BP36654CCZ	Pull	Clear/Champagne Bronze	3-3/4 (96) CTC	5-5/16 (135)	3/4 (19)	1-1/2 (38)	5/8 L x 5/8 W (16 L x 16 W)	Zinc/Glass	(2) #8-32 x 1in Truss Head Machine Screw (2) #8-32 x 1-1/2in Truss Head Machine Screw	N/A
BP36654CG10	Pull	Clear/Satin Nickel	3-3/4 (96) CTC	5-5/16 (135)	3/4 (19)	1-1/2 (38)	5/8 L x 5/8 W (16 L x 16 W)	Zinc/Glass	(2) #8-32 x 1in Truss Head Machine Screw (2) #8-32 x 1-1/2in Truss Head Machine Screw	N/A
BP36654CGM	Pull	Clear/Gunmetal	3-3/4 (96) CTC	5-5/16 (135)	3/4 (19)	1-1/2 (38)	5/8 L x 5/8 W (16 L x 16 W)	Zinc/Glass	(2) #8-32 x 1in Truss Head Machine Screw (2) #8-32 x 1-1/2in Truss Head Machine Screw	N/A
BP36654CORB	Pull	Clear/Oil-Rubbed Bronze	3-3/4 (96) CTC	5-5/16 (135)	3/4 (19)	1-1/2 (38)	5/8 L x 5/8 W (16 L x 16 W)	Zinc/Glass	(2) #8-32 x 1in Truss Head Machine Screw (2) #8-32 x 1-1/2in Truss Head Machine Screw	N/A
BP36654CPN	Pull	Clear/Polished Nickel	3-3/4 (96) CTC	5-5/16 (135)	3/4 (19)	1-1/2 (38)	5/8 L x 5/8 W (16 L x 16 W)	Zinc/Glass	(2) #8-32 x 1in Truss Head Machine Screw (2) #8-32 x 1-1/2in Truss Head Machine Screw	N/A
BP36655C26	Pull	Clear/Polished Chrome	5-1/16 (128) CTC	6-9/16 (167)	3/4 (19)	1-1/2 (38)	5/8 L x 5/8 W (16 L x 16 W)	Zinc/Glass	(2) #8-32 x 1in Truss Head Machine Screw (2) #8-32 x 1-1/2in Truss Head Machine Screw	N/A
BP36655CBBR	Pull	Clear/Black Bronze	5-1/16 (128) CTC	6-9/16 (167)	3/4 (19)	1-1/2 (38)	5/8 L x 5/8 W (16 L x 16 W)	Zinc/Glass	(2) #8-32 x 1in Truss Head Machine Screw (2) #8-32 x 1-1/2in Truss Head Machine Screw	N/A
BP36655CBBZ	Pull	Clear/Golden Champagne	5-1/16 (128) CTC	6-9/16 (167)	3/4 (19)	1-1/2 (38)	5/8 L x 5/8 W (16 L x 16 W)	Zinc/Glass	(2) #8-32 x 1in Truss Head Machine Screw (2) #8-32 x 1-1/2in Truss Head Machine Screw	N/A
BP36655CCZ	Pull	Clear/Champagne Bronze	5-1/16 (128) CTC	6-9/16 (167)	3/4 (19)	1-1/2 (38)	5/8 L x 5/8 W (16 L x 16 W)	Zinc/Glass	(2) #8-32 x 1in Truss Head Machine Screw (2) #8-32 x 1-1/2in Truss Head Machine Screw	N/A
BP36655CG10	Pull	Clear/Satin Nickel	5-1/16 (128) CTC	6-9/16 (167)	3/4 (19)	1-1/2 (38)	5/8 L x 5/8 W (16 L x 16 W)	Zinc/Glass	(2) #8-32 x 1in Truss Head Machine Screw (2) #8-32 x 1-1/2in Truss Head Machine Screw	N/A
BP36655CGM	Pull	Clear/Gunmetal	5-1/16 (128) CTC	6-9/16 (167)	3/4 (19)	1-1/2 (38)	5/8 L x 5/8 W (16 L x 16 W)	Zinc/Glass	(2) #8-32 x 1in Truss Head Machine Screw (2) #8-32 x 1-1/2in Truss Head Machine Screw	N/A
BP36655CORB	Pull	Clear/Oil-Rubbed Bronze	5-1/16 (128) CTC	6-9/16 (167)	3/4 (19)	1-1/2 (38)	5/8 L x 5/8 W (16 L x 16 W)	Zinc/Glass	(2) #8-32 x 1in Truss Head Machine Screw (2) #8-32 x 1-1/2in Truss Head Machine Screw	N/A
BP36655CPN	Pull	Clear/Polished Nickel	5-1/16 (128) CTC	6-9/16 (167)	3/4 (19)	1-1/2 (38)	5/8 L x 5/8 W (16 L x 16 W)	Zinc/Glass	(2) #8-32 x 1in Truss Head Machine Screw (2) #8-32 x 1-1/2in Truss Head Machine Screw	N/A
BP36656C26	Pull	Clear/Polished Chrome	6-5/16 (160) CTC	7-7/8 (200)	3/4 (19)	1-1/2 (38)	5/8 L x 5/8 W (16 L x 16 W)	Zinc/Glass	(2) #8-32 x 1in Truss Head Machine Screw (2) #8-32 x 1-1/2in Truss Head Machine Screw	N/A

Mounting hardware included.  
The dimensional information provided here should be verified with the actual product prior to drilling or attempting to install the hardware.  
Please direct any questions you may have on the installation process to Amerock Customer Service (see back cover for contact information).



# PRODUCT INDEX

Product No.	Type	Finish	Product Detail in (mm)	Length in (mm)	Width in (mm)	Projection in (mm)	Base Dimensions in (mm)	Base Material	Mounting Hardware Included	ADA-Friendly
<b>Glacio (continued) • p. 46</b>										
BP36656CBBR	Pull	Clear/Black Bronze	6-5/16 (160) CTC	7-7/8 (200)	3/4 (19)	1-1/2 (38)	5/8 L x 5/8 W (16 L x 16 W)	Zinc/Glass	(2) #8-32 x 1in Truss Head Machine Screw (2) #8-32 x 1-1/2in Truss Head Machine Screw	N/A
BP36656CBBZ	Pull	Clear/Golden Champagne	6-5/16 (160) CTC	7-7/8 (200)	3/4 (19)	1-1/2 (38)	5/8 L x 5/8 W (16 L x 16 W)	Zinc/Glass	(2) #8-32 x 1in Truss Head Machine Screw (2) #8-32 x 1-1/2in Truss Head Machine Screw	N/A
BP36656CCZ	Pull	Clear/Champagne Bronze	6-5/16 (160) CTC	7-7/8 (200)	3/4 (19)	1-1/2 (38)	5/8 L x 5/8 W (16 L x 16 W)	Zinc/Glass	(2) #8-32 x 1in Truss Head Machine Screw (2) #8-32 x 1-1/2in Truss Head Machine Screw	N/A
BP36656CG10	Pull	Clear/Satin Nickel	6-5/16 (160) CTC	7-7/8 (200)	3/4 (19)	1-1/2 (38)	5/8 L x 5/8 W (16 L x 16 W)	Zinc/Glass	(2) #8-32 x 1in Truss Head Machine Screw (2) #8-32 x 1-1/2in Truss Head Machine Screw	N/A
BP36656CGM	Pull	Clear/Gunmetal	6-5/16 (160) CTC	7-7/8 (200)	3/4 (19)	1-1/2 (38)	5/8 L x 5/8 W (16 L x 16 W)	Zinc/Glass	(2) #8-32 x 1in Truss Head Machine Screw (2) #8-32 x 1-1/2in Truss Head Machine Screw	N/A
BP36656CORB	Pull	Clear/Oil-Rubbed Bronze	6-5/16 (160) CTC	7-7/8 (200)	3/4 (19)	1-1/2 (38)	5/8 L x 5/8 W (16 L x 16 W)	Zinc/Glass	(2) #8-32 x 1in Truss Head Machine Screw (2) #8-32 x 1-1/2in Truss Head Machine Screw	N/A
BP36656CPN	Pull	Clear/Polished Nickel	6-5/16 (160) CTC	7-7/8 (200)	3/4 (19)	1-1/2 (38)	5/8 L x 5/8 W (16 L x 16 W)	Zinc/Glass	(2) #8-32 x 1in Truss Head Machine Screw (2) #8-32 x 1-1/2in Truss Head Machine Screw	N/A
BP36659C26	Pull	Clear/Polished Chrome	3 (76) CTC	4-9/16 (116)	3/4 (19)	1-1/2 (38)	5/8 L x 5/8 W (16 L x 16 W)	Zinc/Glass	(2) #8-32 x 1in Truss Head Machine Screw (2) #8-32 x 1-1/2in Truss Head Machine Screw	N/A
BP36659CBBR	Pull	Clear/Black Bronze	3 (76) CTC	4-9/16 (116)	3/4 (19)	1-1/2 (38)	5/8 L x 5/8 W (16 L x 16 W)	Zinc/Glass	(2) #8-32 x 1in Truss Head Machine Screw (2) #8-32 x 1-1/2in Truss Head Machine Screw	N/A
BP36659CBBZ	Pull	Clear/Golden Champagne	3 (76) CTC	4-9/16 (116)	3/4 (19)	1-1/2 (38)	5/8 L x 5/8 W (16 L x 16 W)	Zinc/Glass	(2) #8-32 x 1in Truss Head Machine Screw (2) #8-32 x 1-1/2in Truss Head Machine Screw	N/A
BP36659CCZ	Pull	Clear/Champagne Bronze	3 (76) CTC	4-9/16 (116)	3/4 (19)	1-1/2 (38)	5/8 L x 5/8 W (16 L x 16 W)	Zinc/Glass	(2) #8-32 x 1in Truss Head Machine Screw (2) #8-32 x 1-1/2in Truss Head Machine Screw	N/A
BP36659CG10	Pull	Clear/Satin Nickel	3 (76) CTC	4-9/16 (116)	3/4 (19)	1-1/2 (38)	5/8 L x 5/8 W (16 L x 16 W)	Zinc/Glass	(2) #8-32 x 1in Truss Head Machine Screw (2) #8-32 x 1-1/2in Truss Head Machine Screw	N/A
BP36659CGM	Pull	Clear/Gunmetal	3 (76) CTC	4-9/16 (116)	3/4 (19)	1-1/2 (38)	5/8 L x 5/8 W (16 L x 16 W)	Zinc/Glass	(2) #8-32 x 1in Truss Head Machine Screw (2) #8-32 x 1-1/2in Truss Head Machine Screw	N/A
BP36659CORB	Pull	Clear/Oil-Rubbed Bronze	3 (76) CTC	4-9/16 (116)	3/4 (19)	1-1/2 (38)	5/8 L x 5/8 W (16 L x 16 W)	Zinc/Glass	(2) #8-32 x 1in Truss Head Machine Screw (2) #8-32 x 1-1/2in Truss Head Machine Screw	N/A
BP36659CPN	Pull	Clear/Polished Nickel	3 (76) CTC	4-9/16 (116)	3/4 (19)	1-1/2 (38)	5/8 L x 5/8 W (16 L x 16 W)	Zinc/Glass	(2) #8-32 x 1in Truss Head Machine Screw (2) #8-32 x 1-1/2in Truss Head Machine Screw	N/A
<b>Carrione • p. 48</b>										
BP36647MBKBBR	Knob	Marble Black/Black Bronze	2-1/2 (64) LGTH	2-1/2 (64)	13/16 (21)	1-9/16 (40)	9/16 L x 3/8 W (14 L x 10 W)	Zinc	(1) #8-32 x 1in Truss Head Machine Screw (1) #8-32 x 1-1/2in Truss Head Machine Screw	N/A
BP36647MBKBBZ	Knob	Marble Black/Golden Champagne	2-1/2 (64) LGTH	2-1/2 (64)	13/16 (21)	1-9/16 (40)	9/16 L x 3/8 W (14 L x 10 W)	Zinc	(1) #8-32 x 1in Truss Head Machine Screw (1) #8-32 x 1-1/2in Truss Head Machine Screw	N/A
BP36647MBKG10	Knob	Marble Black/Satin Nickel	2-1/2 (64) LGTH	2-1/2 (64)	13/16 (21)	1-9/16 (40)	9/16 L x 3/8 W (14 L x 10 W)	Zinc	(1) #8-32 x 1in Truss Head Machine Screw (1) #8-32 x 1-1/2in Truss Head Machine Screw	N/A
BP36647MBKPN	Knob	Marble Black/Polished Nickel	2-1/2 (64) LGTH	2-1/2 (64)	13/16 (21)	1-9/16 (40)	9/16 L x 3/8 W (14 L x 10 W)	Zinc	(1) #8-32 x 1in Truss Head Machine Screw (1) #8-32 x 1-1/2in Truss Head Machine Screw	N/A
BP36647MWBBR	Knob	Marble White/Black Bronze	2-1/2 (64) LGTH	2-1/2 (64)	13/16 (21)	1-9/16 (40)	9/16 L x 3/8 W (14 L x 10 W)	Zinc	(1) #8-32 x 1in Truss Head Machine Screw (1) #8-32 x 1-1/2in Truss Head Machine Screw	N/A
BP36647MWBBZ	Knob	Marble White/Golden Champagne	2-1/2 (64) LGTH	2-1/2 (64)	13/16 (21)	1-9/16 (40)	9/16 L x 3/8 W (14 L x 10 W)	Zinc	(1) #8-32 x 1in Truss Head Machine Screw (1) #8-32 x 1-1/2in Truss Head Machine Screw	N/A
BP36647MWG10	Knob	Marble White/Satin Nickel	2-1/2 (64) LGTH	2-1/2 (64)	13/16 (21)	1-9/16 (40)	9/16 L x 3/8 W (14 L x 10 W)	Zinc	(1) #8-32 x 1in Truss Head Machine Screw (1) #8-32 x 1-1/2in Truss Head Machine Screw	N/A
BP36647MWORB	Knob	Marble White/Oil-Rubbed Bronze	2-1/2 (64) LGTH	2-1/2 (64)	13/16 (21)	1-9/16 (40)	9/16 L x 3/8 W (14 L x 10 W)	Zinc	(1) #8-32 x 1in Truss Head Machine Screw (1) #8-32 x 1-1/2in Truss Head Machine Screw	N/A
BP36647MWPN	Knob	Marble White/Polished Nickel	2-1/2 (64) LGTH	2-1/2 (64)	13/16 (21)	1-9/16 (40)	9/16 L x 3/8 W (14 L x 10 W)	Zinc	(1) #8-32 x 1in Truss Head Machine Screw (1) #8-32 x 1-1/2in Truss Head Machine Screw	N/A

Mounting hardware included.  
The dimensional information provided here should be verified with the actual product prior to drilling or attempting to install the hardware.  
Please direct any questions you may have on the installation process to Amerock Customer Service (see back cover for contact information).

# PRODUCT INDEX

Product No.	Type	Finish	Product Detail in (mm)	Length in (mm)	Width in (mm)	Projection in (mm)	Base Dimensions in (mm)	Base Material	Mounting Hardware Included	ADA-Friendly
<b>Carrione (continued) • p. 48</b>										
BP36648MBKBBR	Pull	Marble Black/Black Bronze	3-3/4 (96) CTC	6-5/16 (160)	13/16 (21)	1-9/16 (40)	9/16 L x 3/8 W (14 L x 10 W)	Zinc	(2) #8-32 x 1in Truss Head Machine Screw (2) #8-32 x 1-1/2in Truss Head Machine Screw	N/A
BP36648MBKBBZ	Pull	Marble Black/Golden Champagne	3-3/4 (96) CTC	6-5/16 (160)	13/16 (21)	1-9/16 (40)	9/16 L x 3/8 W (14 L x 10 W)	Zinc	(2) #8-32 x 1in Truss Head Machine Screw (2) #8-32 x 1-1/2in Truss Head Machine Screw	N/A
BP36648MBKG10	Pull	Marble Black/Satin Nickel	3-3/4 (96) CTC	6-5/16 (160)	13/16 (21)	1-9/16 (40)	9/16 L x 3/8 W (14 L x 10 W)	Zinc	(2) #8-32 x 1in Truss Head Machine Screw (2) #8-32 x 1-1/2in Truss Head Machine Screw	N/A
BP36648MBKPN	Pull	Marble Black/Polished Nickel	3-3/4 (96) CTC	6-5/16 (160)	13/16 (21)	1-9/16 (40)	9/16 L x 3/8 W (14 L x 10 W)	Zinc	(2) #8-32 x 1in Truss Head Machine Screw (2) #8-32 x 1-1/2in Truss Head Machine Screw	N/A
BP36648MWBBR	Pull	Marble White/Black Bronze	3-3/4 (96) CTC	6-5/16 (160)	13/16 (21)	1-9/16 (40)	9/16 L x 3/8 W (14 L x 10 W)	Zinc	(2) #8-32 x 1in Truss Head Machine Screw (2) #8-32 x 1-1/2in Truss Head Machine Screw	N/A
BP36648MWBBZ	Pull	Marble White/Golden Champagne	3-3/4 (96) CTC	6-5/16 (160)	13/16 (21)	1-9/16 (40)	9/16 L x 3/8 W (14 L x 10 W)	Zinc	(2) #8-32 x 1in Truss Head Machine Screw (2) #8-32 x 1-1/2in Truss Head Machine Screw	N/A
BP36648MWG10	Pull	Marble White/Satin Nickel	3-3/4 (96) CTC	6-5/16 (160)	13/16 (21)	1-9/16 (40)	9/16 L x 3/8 W (14 L x 10 W)	Zinc	(2) #8-32 x 1in Truss Head Machine Screw (2) #8-32 x 1-1/2in Truss Head Machine Screw	N/A
BP36648MWORB	Pull	Marble White/Oil-Rubbed Bronze	3-3/4 (96) CTC	6-5/16 (160)	13/16 (21)	1-9/16 (40)	9/16 L x 3/8 W (14 L x 10 W)	Zinc	(2) #8-32 x 1in Truss Head Machine Screw (2) #8-32 x 1-1/2in Truss Head Machine Screw	N/A
BP36648MWPN	Pull	Marble White/Polished Nickel	3-3/4 (96) CTC	6-5/16 (160)	13/16 (21)	1-9/16 (40)	9/16 L x 3/8 W (14 L x 10 W)	Zinc	(2) #8-32 x 1in Truss Head Machine Screw (2) #8-32 x 1-1/2in Truss Head Machine Screw	N/A
BP36649MBKBBR	Pull	Marble Black/Black Bronze	5-1/16 (128) CTC	7-1/2 (191)	13/16 (21)	1-9/16 (40)	9/16 L x 3/8 W (14 L x 10 W)	Zinc	(2) #8-32 x 1in Truss Head Machine Screw (2) #8-32 x 1-1/2in Truss Head Machine Screw	N/A
BP36649MBKBBZ	Pull	Marble Black/Golden Champagne	5-1/16 (128) CTC	7-1/2 (191)	13/16 (21)	1-9/16 (40)	9/16 L x 3/8 W (14 L x 10 W)	Zinc	(2) #8-32 x 1in Truss Head Machine Screw (2) #8-32 x 1-1/2in Truss Head Machine Screw	N/A
BP36649MBKG10	Pull	Marble Black/Satin Nickel	5-1/16 (128) CTC	7-1/2 (191)	13/16 (21)	1-9/16 (40)	9/16 L x 3/8 W (14 L x 10 W)	Zinc	(2) #8-32 x 1in Truss Head Machine Screw (2) #8-32 x 1-1/2in Truss Head Machine Screw	N/A
BP36649MBKPN	Pull	Marble Black/Polished Nickel	5-1/16 (128) CTC	7-1/2 (191)	13/16 (21)	1-9/16 (40)	9/16 L x 3/8 W (14 L x 10 W)	Zinc	(2) #8-32 x 1in Truss Head Machine Screw (2) #8-32 x 1-1/2in Truss Head Machine Screw	N/A
BP36649MWBBR	Pull	Marble White/Black Bronze	5-1/16 (128) CTC	7-1/2 (191)	13/16 (21)	1-9/16 (40)	9/16 L x 3/8 W (14 L x 10 W)	Zinc	(2) #8-32 x 1in Truss Head Machine Screw (2) #8-32 x 1-1/2in Truss Head Machine Screw	N/A
BP36649MWBBZ	Pull	Marble White/Golden Champagne	5-1/16 (128) CTC	7-1/2 (191)	13/16 (21)	1-9/16 (40)	9/16 L x 3/8 W (14 L x 10 W)	Zinc	(2) #8-32 x 1in Truss Head Machine Screw (2) #8-32 x 1-1/2in Truss Head Machine Screw	N/A
BP36649MWG10	Pull	Marble White/Satin Nickel	5-1/16 (128) CTC	7-1/2 (191)	13/16 (21)	1-9/16 (40)	9/16 L x 3/8 W (14 L x 10 W)	Zinc	(2) #8-32 x 1in Truss Head Machine Screw (2) #8-32 x 1-1/2in Truss Head Machine Screw	N/A
BP36649MWORB	Pull	Marble White/Oil-Rubbed Bronze	5-1/16 (128) CTC	7-1/2 (191)	13/16 (21)	1-9/16 (40)	9/16 L x 3/8 W (14 L x 10 W)	Zinc	(2) #8-32 x 1in Truss Head Machine Screw (2) #8-32 x 1-1/2in Truss Head Machine Screw	N/A
BP36649MWPN	Pull	Marble White/Polished Nickel	5-1/16 (128) CTC	7-1/2 (191)	13/16 (21)	1-9/16 (40)	9/16 L x 3/8 W (14 L x 10 W)	Zinc	(2) #8-32 x 1in Truss Head Machine Screw (2) #8-32 x 1-1/2in Truss Head Machine Screw	N/A
BP36650MBKBBR	Pull	Marble Black/Black Bronze	6-5/16 (160) CTC	8-3/4 (222)	13/16 (21)	1-9/16 (40)	9/16 L x 3/8 W (14 L x 10 W)	Zinc	(2) #8-32 x 1in Truss Head Machine Screw (2) #8-32 x 1-1/2in Truss Head Machine Screw	N/A
BP36650MBKBBZ	Pull	Marble Black/Golden Champagne	6-5/16 (160) CTC	8-3/4 (222)	13/16 (21)	1-9/16 (40)	9/16 L x 3/8 W (14 L x 10 W)	Zinc	(2) #8-32 x 1in Truss Head Machine Screw (2) #8-32 x 1-1/2in Truss Head Machine Screw	N/A
BP36650MBKG10	Pull	Marble Black/Satin Nickel	6-5/16 (160) CTC	8-3/4 (222)	13/16 (21)	1-9/16 (40)	9/16 L x 3/8 W (14 L x 10 W)	Zinc	(2) #8-32 x 1in Truss Head Machine Screw (2) #8-32 x 1-1/2in Truss Head Machine Screw	N/A
BP36650MBKPN	Pull	Marble Black/Polished Nickel	6-5/16 (160) CTC	8-3/4 (222)	13/16 (21)	1-9/16 (40)	9/16 L x 3/8 W (14 L x 10 W)	Zinc	(2) #8-32 x 1in Truss Head Machine Screw (2) #8-32 x 1-1/2in Truss Head Machine Screw	N/A
BP36650MWBBR	Pull	Marble White/Black Bronze	6-5/16 (160) CTC	8-3/4 (222)	13/16 (21)	1-9/16 (40)	9/16 L x 3/8 W (14 L x 10 W)	Zinc	(2) #8-32 x 1in Truss Head Machine Screw (2) #8-32 x 1-1/2in Truss Head Machine Screw	N/A
BP36650MWBBZ	Pull	Marble White/Golden Champagne	6-5/16 (160) CTC	8-3/4 (222)	13/16 (21)	1-9/16 (40)	9/16 L x 3/8 W (14 L x 10 W)	Zinc	(2) #8-32 x 1in Truss Head Machine Screw (2) #8-32 x 1-1/2in Truss Head Machine Screw	N/A
BP36650MWG10	Pull	Marble White/Satin Nickel	6-5/16 (160) CTC	8-3/4 (222)	13/16 (21)	1-9/16 (40)	9/16 L x 3/8 W (14 L x 10 W)	Zinc	(2) #8-32 x 1in Truss Head Machine Screw (2) #8-32 x 1-1/2in Truss Head Machine Screw	N/A

Mounting hardware included.  
The dimensional information provided here should be verified with the actual product prior to drilling or attempting to install the hardware.  
Please direct any questions you may have on the installation process to Amerock Customer Service (see back cover for contact information).

# PRODUCT INDEX

Product No.	Type	Finish	Product Detail in (mm)	Length in (mm)	Width in (mm)	Projection in (mm)	Base Dimensions in (mm)	Base Material	Mounting Hardware Included	ADA-Friendly
<b>Carrione (continued) • p. 48</b>										
BP36650MWORB	Pull	Marble White/ Oil-Rubbed Bronze	6-5/16 (160) CTC	8-3/4 (222)	13/16 (21)	1-9/16 (40)	9/16 L x 3/8 W (14 L x 10 W)	Zinc	(2) #8-32 x 1in Truss Head Machine Screw (2) #8-32 x 1-1/2in Truss Head Machine Screw	N/A
BP36650MWPN	Pull	Marble White/ Polished Nickel	6-5/16 (160) CTC	8-3/4 (222)	13/16 (21)	1-9/16 (40)	9/16 L x 3/8 W (14 L x 10 W)	Zinc	(2) #8-32 x 1in Truss Head Machine Screw (2) #8-32 x 1-1/2in Truss Head Machine Screw	N/A
<b>St. Vincent • p. 50</b>										
BH3604026	Robe Hook	Chrome	Single	3-7/16 (87)	11/16 (17)	2-7/8 (73)	2-3/8 L x 1-9/16 W (60 L x 40 W)	Zinc	(2) #8 x 1-1/4 in. Sheet Metal Screw (1) Mounting Bracket	N/A
BH36040BBZ	Robe Hook	Golden Champagne	Single	3-7/16 (87)	11/16 (17)	2-7/8 (73)	2-3/8 L x 1-9/16 W (60 L x 40 W)	Zinc	(2) #8 x 1-1/4 in. Sheet Metal Screw (1) Mounting Bracket	N/A
BH36040CZ	Robe Hook	Champagne Bronze	Single	3-7/16 (87)	11/16 (17)	2-7/8 (73)	2-3/8 L x 1-9/16 W (60 L x 40 W)	Zinc	(2) #8 x 1-1/4 in. Sheet Metal Screw (1) Mounting Bracket	N/A
BH36040G10	Robe Hook	Brushed Nickel	Single	3-7/16 (87)	11/16 (17)	2-7/8 (73)	2-3/8 L x 1-9/16 W (60 L x 40 W)	Zinc	(2) #8 x 1-1/4 in. Sheet Metal Screw (1) Mounting Bracket	N/A
BH36040MB	Robe Hook	Matte Black	Single	3-7/16 (87)	11/16 (17)	2-7/8 (73)	2-3/8 L x 1-9/16 W (60 L x 40 W)	Zinc	(2) #8 x 1-1/4 in. Sheet Metal Screw (1) Mounting Bracket	N/A
BH36040ORB	Robe Hook	Oil-Rubbed Bronze	Single	3-7/16 (87)	11/16 (17)	2-7/8 (73)	2-3/8 L x 1-9/16 W (60 L x 40 W)	Zinc	(2) #8 x 1-1/4 in. Sheet Metal Screw (1) Mounting Bracket	N/A
BP3664226	Knob	Polished Chrome	2-1/2 (64) LGTH	2-1/2 (64)	5/8 (16)	1-7/16 (37)	1/2 L x 3/8 W (13 L x 10 W)	Zinc	(1) #8-32 x 1in Truss Head Machine Screw (1) #8-32 x 1-1/2in Truss Head Machine Screw	N/A
BP36642BBR	Knob	Black Bronze	2-1/2 (64) LGTH	2-1/2 (64)	5/8 (16)	1-7/16 (37)	1/2 L x 3/8 W (13 L x 10 W)	Zinc	(1) #8-32 x 1in Truss Head Machine Screw (1) #8-32 x 1-1/2in Truss Head Machine Screw	N/A
BP36642BBZ	Knob	Golden Champagne	2-1/2 (64) LGTH	2-1/2 (64)	5/8 (16)	1-7/16 (37)	1/2 L x 3/8 W (13 L x 10 W)	Zinc	(1) #8-32 x 1in Truss Head Machine Screw (1) #8-32 x 1-1/2in Truss Head Machine Screw	N/A
BP36642CZ	Knob	Champagne Bronze	2-1/2 (64) LGTH	2-1/2 (64)	5/8 (16)	1-7/16 (37)	1/2 L x 3/8 W (13 L x 10 W)	Zinc	(1) #8-32 x 1in Truss Head Machine Screw (1) #8-32 x 1-1/2in Truss Head Machine Screw	N/A
BP36642G10	Knob	Satin Nickel	2-1/2 (64) LGTH	2-1/2 (64)	5/8 (16)	1-7/16 (37)	1/2 L x 3/8 W (13 L x 10 W)	Zinc	(1) #8-32 x 1in Truss Head Machine Screw (1) #8-32 x 1-1/2in Truss Head Machine Screw	N/A
BP36642ORB	Knob	Oil-Rubbed Bronze	2-1/2 (64) LGTH	2-1/2 (64)	5/8 (16)	1-7/16 (37)	1/2 L x 3/8 W (13 L x 10 W)	Zinc	(1) #8-32 x 1in Truss Head Machine Screw (1) #8-32 x 1-1/2in Truss Head Machine Screw	N/A
BP36642PN	Knob	Polished Nickel	2-1/2 (64) LGTH	2-1/2 (64)	5/8 (16)	1-7/16 (37)	1/2 L x 3/8 W (13 L x 10 W)	Zinc	(1) #8-32 x 1in Truss Head Machine Screw (1) #8-32 x 1-1/2in Truss Head Machine Screw	N/A
BP3664326	Pull	Polished Chrome	3-3/4 (96) CTC	6-5/16 (160)	5/8 (16)	1-7/16 (37)	1/2 L x 3/8 W (13 L x 10 W)	Zinc	(2) #8-32 x 1in Truss Head Machine Screw (2) #8-32 x 1-1/2in Truss Head Machine Screw	N/A
BP36643BBR	Pull	Black Bronze	3-3/4 (96) CTC	6-5/16 (160)	5/8 (16)	1-7/16 (37)	1/2 L x 3/8 W (13 L x 10 W)	Zinc	(2) #8-32 x 1in Truss Head Machine Screw (2) #8-32 x 1-1/2in Truss Head Machine Screw	N/A
BP36643BBZ	Pull	Golden Champagne	3-3/4 (96) CTC	6-5/16 (160)	5/8 (16)	1-7/16 (37)	1/2 L x 3/8 W (13 L x 10 W)	Zinc	(2) #8-32 x 1in Truss Head Machine Screw (2) #8-32 x 1-1/2in Truss Head Machine Screw	N/A
BP36643CZ	Pull	Champagne Bronze	3-3/4 (96) CTC	6-5/16 (160)	5/8 (16)	1-7/16 (37)	1/2 L x 3/8 W (13 L x 10 W)	Zinc	(2) #8-32 x 1in Truss Head Machine Screw (2) #8-32 x 1-1/2in Truss Head Machine Screw	N/A
BP36643G10	Pull	Satin Nickel	3-3/4 (96) CTC	6-5/16 (160)	5/8 (16)	1-7/16 (37)	1/2 L x 3/8 W (13 L x 10 W)	Zinc	(2) #8-32 x 1in Truss Head Machine Screw (2) #8-32 x 1-1/2in Truss Head Machine Screw	N/A
BP36643ORB	Pull	Oil-Rubbed Bronze	3-3/4 (96) CTC	6-5/16 (160)	5/8 (16)	1-7/16 (37)	1/2 L x 3/8 W (13 L x 10 W)	Zinc	(2) #8-32 x 1in Truss Head Machine Screw (2) #8-32 x 1-1/2in Truss Head Machine Screw	N/A
BP36643PN	Pull	Polished Nickel	3-3/4 (96) CTC	6-5/16 (160)	5/8 (16)	1-7/16 (37)	1/2 L x 3/8 W (13 L x 10 W)	Zinc	(2) #8-32 x 1in Truss Head Machine Screw (2) #8-32 x 1-1/2in Truss Head Machine Screw	N/A
BP3664426	Pull	Polished Chrome	5-1/16 (128) CTC	7-1/2 (191)	5/8 (16)	1-7/16 (37)	1/2 L x 3/8 W (13 L x 10 W)	Zinc	(2) #8-32 x 1in Truss Head Machine Screw (2) #8-32 x 1-1/2in Truss Head Machine Screw	N/A
BP36644BBR	Pull	Black Bronze	5-1/16 (128) CTC	7-1/2 (191)	5/8 (16)	1-7/16 (37)	1/2 L x 3/8 W (13 L x 10 W)	Zinc	(2) #8-32 x 1in Truss Head Machine Screw (2) #8-32 x 1-1/2in Truss Head Machine Screw	N/A

Mounting hardware included.  
The dimensional information provided here should be verified with the actual product prior to drilling or attempting to install the hardware.  
Please direct any questions you may have on the installation process to Amerock Customer Service (see back cover for contact information).

# PRODUCT INDEX

Product No.	Type	Finish	Product Detail in (mm)	Length in (mm)	Width in (mm)	Projection in (mm)	Base Dimensions in (mm)	Base Material	Mounting Hardware Included	ADA-Friendly
<b>St. Vincent (continued) • p. 50</b>										
BP36644BBZ	Pull	Golden Champagne	5-1/16 (128) CTC	7-1/2 (191)	5/8 (16)	1-7/16 (37)	1/2 L x 3/8 W (13 L x 10 W)	Zinc	(2) #8-32 x 1in Truss Head Machine Screw (2) #8-32 x 1-1/2in Truss Head Machine Screw	N/A
BP36644CZ	Pull	Champagne Bronze	5-1/16 (128) CTC	7-1/2 (191)	5/8 (16)	1-7/16 (37)	1/2 L x 3/8 W (13 L x 10 W)	Zinc	(2) #8-32 x 1in Truss Head Machine Screw (2) #8-32 x 1-1/2in Truss Head Machine Screw	N/A
BP36644G10	Pull	Satin Nickel	5-1/16 (128) CTC	7-1/2 (191)	5/8 (16)	1-7/16 (37)	1/2 L x 3/8 W (13 L x 10 W)	Zinc	(2) #8-32 x 1in Truss Head Machine Screw (2) #8-32 x 1-1/2in Truss Head Machine Screw	N/A
BP36644ORB	Pull	Oil-Rubbed Bronze	5-1/16 (128) CTC	7-1/2 (191)	5/8 (16)	1-7/16 (37)	1/2 L x 3/8 W (13 L x 10 W)	Zinc	(2) #8-32 x 1in Truss Head Machine Screw (2) #8-32 x 1-1/2in Truss Head Machine Screw	N/A
BP36644PN	Pull	Polished Nickel	5-1/16 (128) CTC	7-1/2 (191)	5/8 (16)	1-7/16 (37)	1/2 L x 3/8 W (13 L x 10 W)	Zinc	(2) #8-32 x 1in Truss Head Machine Screw (2) #8-32 x 1-1/2in Truss Head Machine Screw	N/A
BP3664526	Pull	Polished Chrome	6-5/16 (160) CTC	8-3/4 (222)	5/8 (16)	1-7/16 (37)	1/2 L x 3/8 W (13 L x 10 W)	Zinc	(2) #8-32 x 1in Truss Head Machine Screw (2) #8-32 x 1-1/2in Truss Head Machine Screw	N/A
BP36645BBR	Pull	Black Bronze	6-5/16 (160) CTC	8-3/4 (222)	5/8 (16)	1-7/16 (37)	1/2 L x 3/8 W (13 L x 10 W)	Zinc	(2) #8-32 x 1in Truss Head Machine Screw (2) #8-32 x 1-1/2in Truss Head Machine Screw	N/A
BP36645BBZ	Pull	Golden Champagne	6-5/16 (160) CTC	8-3/4 (222)	5/8 (16)	1-7/16 (37)	1/2 L x 3/8 W (13 L x 10 W)	Zinc	(2) #8-32 x 1in Truss Head Machine Screw (2) #8-32 x 1-1/2in Truss Head Machine Screw	N/A
BP36645CZ	Pull	Champagne Bronze	6-5/16 (160) CTC	8-3/4 (222)	5/8 (16)	1-7/16 (37)	1/2 L x 3/8 W (13 L x 10 W)	Zinc	(2) #8-32 x 1in Truss Head Machine Screw (2) #8-32 x 1-1/2in Truss Head Machine Screw	N/A
BP36645G10	Pull	Satin Nickel	6-5/16 (160) CTC	8-3/4 (222)	5/8 (16)	1-7/16 (37)	1/2 L x 3/8 W (13 L x 10 W)	Zinc	(2) #8-32 x 1in Truss Head Machine Screw (2) #8-32 x 1-1/2in Truss Head Machine Screw	N/A
BP36645ORB	Pull	Oil-Rubbed Bronze	6-5/16 (160) CTC	8-3/4 (222)	5/8 (16)	1-7/16 (37)	1/2 L x 3/8 W (13 L x 10 W)	Zinc	(2) #8-32 x 1in Truss Head Machine Screw (2) #8-32 x 1-1/2in Truss Head Machine Screw	N/A
BP36645PN	Pull	Polished Nickel	6-5/16 (160) CTC	8-3/4 (222)	5/8 (16)	1-7/16 (37)	1/2 L x 3/8 W (13 L x 10 W)	Zinc	(2) #8-32 x 1in Truss Head Machine Screw (2) #8-32 x 1-1/2in Truss Head Machine Screw	N/A
BP3664626	Pull	Polished Chrome	3 (76) CTC	5-7/16 (138)	5/8 (16)	1-7/16 (37)	1/2 L x 3/8 W (13 L x 10 W)	Zinc	(2) #8-32 x 1in Truss Head Machine Screw (2) #8-32 x 1-1/2in Truss Head Machine Screw	N/A
BP36646BBR	Pull	Black Bronze	3 (76) CTC	5-7/16 (138)	5/8 (16)	1-7/16 (37)	1/2 L x 3/8 W (13 L x 10 W)	Zinc	(2) #8-32 x 1in Truss Head Machine Screw (2) #8-32 x 1-1/2in Truss Head Machine Screw	N/A
BP36646BBZ	Pull	Golden Champagne	3 (76) CTC	5-7/16 (138)	5/8 (16)	1-7/16 (37)	1/2 L x 3/8 W (13 L x 10 W)	Zinc	(2) #8-32 x 1in Truss Head Machine Screw (2) #8-32 x 1-1/2in Truss Head Machine Screw	N/A
BP36646CZ	Pull	Champagne Bronze	3 (76) CTC	5-7/16 (138)	5/8 (16)	1-7/16 (37)	1/2 L x 3/8 W (13 L x 10 W)	Zinc	(2) #8-32 x 1in Truss Head Machine Screw (2) #8-32 x 1-1/2in Truss Head Machine Screw	N/A
BP36646G10	Pull	Satin Nickel	3 (76) CTC	5-7/16 (138)	5/8 (16)	1-7/16 (37)	1/2 L x 3/8 W (13 L x 10 W)	Zinc	(2) #8-32 x 1in Truss Head Machine Screw (2) #8-32 x 1-1/2in Truss Head Machine Screw	N/A
BP36646ORB	Pull	Oil-Rubbed Bronze	3 (76) CTC	5-7/16 (138)	5/8 (16)	1-7/16 (37)	1/2 L x 3/8 W (13 L x 10 W)	Zinc	(2) #8-32 x 1in Truss Head Machine Screw (2) #8-32 x 1-1/2in Truss Head Machine Screw	N/A
BP36646PN	Pull	Polished Nickel	3 (76) CTC	5-7/16 (138)	5/8 (16)	1-7/16 (37)	1/2 L x 3/8 W (13 L x 10 W)	Zinc	(2) #8-32 x 1in Truss Head Machine Screw (2) #8-32 x 1-1/2in Truss Head Machine Screw	N/A
<b>London • p. 52</b>										
BP36647BBR26	Knob	Black Bronze/ Polished Chrome	2-1/2 (64) LGTH	2-1/2 (64)	13/16 (21)	1-9/16 (40)	9/16 L x 3/8 W (14 L x 10 W)	Zinc	(1) #8-32 x 1in Truss Head Machine Screw (1) #8-32 x 1-1/2in Truss Head Machine Screw	N/A
BP36647BBRBBZ	Knob	Black Bronze/ Golden Champagne	2-1/2 (64) LGTH	2-1/2 (64)	13/16 (21)	1-9/16 (40)	9/16 L x 3/8 W (14 L x 10 W)	Zinc	(1) #8-32 x 1in Truss Head Machine Screw (1) #8-32 x 1-1/2in Truss Head Machine Screw	N/A
BP36647BBRG10	Knob	Black Bronze/ Satin Nickel	2-1/2 (64) LGTH	2-1/2 (64)	13/16 (21)	1-9/16 (40)	9/16 L x 3/8 W (14 L x 10 W)	Zinc	(1) #8-32 x 1in Truss Head Machine Screw (1) #8-32 x 1-1/2in Truss Head Machine Screw	N/A
BP36647BBZ26	Knob	Golden Champagne/ Polished Chrome	2-1/2 (64) LGTH	2-1/2 (64)	13/16 (21)	1-9/16 (40)	9/16 L x 3/8 W (14 L x 10 W)	Zinc	(1) #8-32 x 1in Truss Head Machine Screw (1) #8-32 x 1-1/2in Truss Head Machine Screw	N/A
BP36647BBZBCR	Knob	Golden Champagne/ Black Chrome	2-1/2 (64) LGTH	2-1/2 (64)	13/16 (21)	1-9/16 (40)	9/16 L x 3/8 W (14 L x 10 W)	Zinc	(1) #8-32 x 1in Truss Head Machine Screw (1) #8-32 x 1-1/2in Truss Head Machine Screw	N/A

Mounting hardware included.  
The dimensional information provided here should be verified with the actual product prior to drilling or attempting to install the hardware.  
Please direct any questions you may have on the installation process to Amerock Customer Service (see back cover for contact information).

# PRODUCT INDEX

Product No.	Type	Finish	Product Detail in (mm)	Length in (mm)	Width in (mm)	Projection in (mm)	Base Dimensions in (mm)	Base Material	Mounting Hardware Included	ADA-Friendly
<b>London (continued) • p. 52</b>										
BP36647BCR26	Knob	Black Chrome/ Polished Chrome	2-1/2 (64) LGTH	2-1/2 (64)	13/16 (21)	1-9/16 (40)	9/16 L x 3/8 W (14 L x 10 W)	Zinc	(1) #8-32 x 1in Truss Head Machine Screw (1) #8-32 x 1-1/2in Truss Head Machine Screw	N/A
BP36647BCRBBZ	Knob	Black Chrome/ Golden Champagne	2-1/2 (64) LGTH	2-1/2 (64)	13/16 (21)	1-9/16 (40)	9/16 L x 3/8 W (14 L x 10 W)	Zinc	(1) #8-32 x 1in Truss Head Machine Screw (1) #8-32 x 1-1/2in Truss Head Machine Screw	N/A
BP36647BCRG10	Knob	Black Chrome/ Satin Nickel	2-1/2 (64) LGTH	2-1/2 (64)	13/16 (21)	1-9/16 (40)	9/16 L x 3/8 W (14 L x 10 W)	Zinc	(1) #8-32 x 1in Truss Head Machine Screw (1) #8-32 x 1-1/2in Truss Head Machine Screw	N/A
BP36647G1026	Knob	Satin Nickel/ Polished Chrome	2-1/2 (64) LGTH	2-1/2 (64)	13/16 (21)	1-9/16 (40)	9/16 L x 3/8 W (14 L x 10 W)	Zinc	(1) #8-32 x 1in Truss Head Machine Screw (1) #8-32 x 1-1/2in Truss Head Machine Screw	N/A
BP36647G10BCR	Knob	Satin Nickel/ Black Chrome	2-1/2 (64) LGTH	2-1/2 (64)	13/16 (21)	1-9/16 (40)	9/16 L x 3/8 W (14 L x 10 W)	Zinc	(1) #8-32 x 1in Truss Head Machine Screw (1) #8-32 x 1-1/2in Truss Head Machine Screw	N/A
BP36647PNBBR	Knob	Polished Nickel/ Black Bronze	2-1/2 (64) LGTH	2-1/2 (64)	13/16 (21)	1-9/16 (40)	9/16 L x 3/8 W (14 L x 10 W)	Zinc	(1) #8-32 x 1in Truss Head Machine Screw (1) #8-32 x 1-1/2in Truss Head Machine Screw	N/A
BP36647PNBCR	Knob	Polished Nickel/ Black Chrome	2-1/2 (64) LGTH	2-1/2 (64)	13/16 (21)	1-9/16 (40)	9/16 L x 3/8 W (14 L x 10 W)	Zinc	(1) #8-32 x 1in Truss Head Machine Screw (1) #8-32 x 1-1/2in Truss Head Machine Screw	N/A
BP36648BBR26	Pull	Black Bronze/ Polished Chrome	3-3/4 (96) CTC	6-5/16 (160)	13/16 (21)	1-9/16 (40)	9/16 L x 3/8 W (14 L x 10 W)	Zinc	(2) #8-32 x 1in Truss Head Machine Screw (2) #8-32 x 1-1/2in Truss Head Machine Screw	N/A
BP36648BBRBBZ	Pull	Black Bronze/ Golden Champagne	3-3/4 (96) CTC	6-5/16 (160)	13/16 (21)	1-9/16 (40)	9/16 L x 3/8 W (14 L x 10 W)	Zinc	(2) #8-32 x 1in Truss Head Machine Screw (2) #8-32 x 1-1/2in Truss Head Machine Screw	N/A
BP36648BBRG10	Pull	Black Bronze/ Satin Nickel	3-3/4 (96) CTC	6-5/16 (160)	13/16 (21)	1-9/16 (40)	9/16 L x 3/8 W (14 L x 10 W)	Zinc	(2) #8-32 x 1in Truss Head Machine Screw (2) #8-32 x 1-1/2in Truss Head Machine Screw	N/A
BP36648BBZ26	Pull	Golden Champagne/ Polished Chrome	3-3/4 (96) CTC	6-5/16 (160)	13/16 (21)	1-9/16 (40)	9/16 L x 3/8 W (14 L x 10 W)	Zinc	(2) #8-32 x 1in Truss Head Machine Screw (2) #8-32 x 1-1/2in Truss Head Machine Screw	N/A
BP36648BBZBCR	Pull	Golden Champagne/ Black Chrome	3-3/4 (96) CTC	6-5/16 (160)	13/16 (21)	1-9/16 (40)	9/16 L x 3/8 W (14 L x 10 W)	Zinc	(2) #8-32 x 1in Truss Head Machine Screw (2) #8-32 x 1-1/2in Truss Head Machine Screw	N/A
BP36648BCR26	Pull	Black Chrome/ Polished Chrome	3-3/4 (96) CTC	6-5/16 (160)	13/16 (21)	1-9/16 (40)	9/16 L x 3/8 W (14 L x 10 W)	Zinc	(2) #8-32 x 1in Truss Head Machine Screw (2) #8-32 x 1-1/2in Truss Head Machine Screw	N/A
BP36648BCRBBZ	Pull	Black Chrome/ Golden Champagne	3-3/4 (96) CTC	6-5/16 (160)	13/16 (21)	1-9/16 (40)	9/16 L x 3/8 W (14 L x 10 W)	Zinc	(2) #8-32 x 1in Truss Head Machine Screw (2) #8-32 x 1-1/2in Truss Head Machine Screw	N/A
BP36648BCRG10	Pull	Black Chrome/ Satin Nickel	3-3/4 (96) CTC	6-5/16 (160)	13/16 (21)	1-9/16 (40)	9/16 L x 3/8 W (14 L x 10 W)	Zinc	(2) #8-32 x 1in Truss Head Machine Screw (2) #8-32 x 1-1/2in Truss Head Machine Screw	N/A
BP36648G1026	Pull	Satin Nickel/ Polished Chrome	3-3/4 (96) CTC	6-5/16 (160)	13/16 (21)	1-9/16 (40)	9/16 L x 3/8 W (14 L x 10 W)	Zinc	(2) #8-32 x 1in Truss Head Machine Screw (2) #8-32 x 1-1/2in Truss Head Machine Screw	N/A
BP36648G10BCR	Pull	Satin Nickel/ Black Chrome	3-3/4 (96) CTC	6-5/16 (160)	13/16 (21)	1-9/16 (40)	9/16 L x 3/8 W (14 L x 10 W)	Zinc	(2) #8-32 x 1in Truss Head Machine Screw (2) #8-32 x 1-1/2in Truss Head Machine Screw	N/A
BP36648PNBBR	Pull	Polished Nickel/ Black Bronze	3-3/4 (96) CTC	6-5/16 (160)	13/16 (21)	1-9/16 (40)	9/16 L x 3/8 W (14 L x 10 W)	Zinc	(2) #8-32 x 1in Truss Head Machine Screw (2) #8-32 x 1-1/2in Truss Head Machine Screw	N/A
BP36648PNBCR	Pull	Polished Nickel/ Black Chrome	3-3/4 (96) CTC	6-5/16 (160)	13/16 (21)	1-9/16 (40)	9/16 L x 3/8 W (14 L x 10 W)	Zinc	(2) #8-32 x 1in Truss Head Machine Screw (2) #8-32 x 1-1/2in Truss Head Machine Screw	N/A
BP36649BBR26	Pull	Black Bronze/ Polished Chrome	5-1/16 (128) CTC	7-1/2 (191)	13/16 (21)	1-9/16 (40)	9/16 L x 3/8 W (14 L x 10 W)	Zinc	(2) #8-32 x 1in Truss Head Machine Screw (2) #8-32 x 1-1/2in Truss Head Machine Screw	N/A
BP36649BBRBBZ	Pull	Black Bronze/ Golden Champagne	5-1/16 (128) CTC	7-1/2 (191)	13/16 (21)	1-9/16 (40)	9/16 L x 3/8 W (14 L x 10 W)	Zinc	(2) #8-32 x 1in Truss Head Machine Screw (2) #8-32 x 1-1/2in Truss Head Machine Screw	N/A
BP36649BBRG10	Pull	Black Bronze/ Satin Nickel	5-1/16 (128) CTC	7-1/2 (191)	13/16 (21)	1-9/16 (40)	9/16 L x 3/8 W (14 L x 10 W)	Zinc	(2) #8-32 x 1in Truss Head Machine Screw (2) #8-32 x 1-1/2in Truss Head Machine Screw	N/A
BP36649BBZ26	Pull	Golden Champagne/ Polished Chrome	5-1/16 (128) CTC	7-1/2 (191)	13/16 (21)	1-9/16 (40)	9/16 L x 3/8 W (14 L x 10 W)	Zinc	(2) #8-32 x 1in Truss Head Machine Screw (2) #8-32 x 1-1/2in Truss Head Machine Screw	N/A
BP36649BBZBCR	Pull	Golden Champagne/ Black Chrome	5-1/16 (128) CTC	7-1/2 (191)	13/16 (21)	1-9/16 (40)	9/16 L x 3/8 W (14 L x 10 W)	Zinc	(2) #8-32 x 1in Truss Head Machine Screw (2) #8-32 x 1-1/2in Truss Head Machine Screw	N/A
BP36649BCR26	Pull	Black Chrome/ Polished Chrome	5-1/16 (128) CTC	7-1/2 (191)	13/16 (21)	1-9/16 (40)	9/16 L x 3/8 W (14 L x 10 W)	Zinc	(2) #8-32 x 1in Truss Head Machine Screw (2) #8-32 x 1-1/2in Truss Head Machine Screw	N/A

Mounting hardware included.  
The dimensional information provided here should be verified with the actual product prior to drilling or attempting to install the hardware.  
Please direct any questions you may have on the installation process to Amerock Customer Service (see back cover for contact information).

# PRODUCT INDEX

Product No.	Type	Finish	Product Detail in (mm)	Length in (mm)	Width in (mm)	Projection in (mm)	Base Dimensions in (mm)	Base Material	Mounting Hardware Included	ADA-Friendly
<b>London (continued) • p. 52</b>										
BP36649BCRBBZ	Pull	Black Chrome/ Golden Champagne	5-1/16 (128) CTC	7-1/2 (191)	13/16 (21)	1-9/16 (40)	9/16 L x 3/8 W (14 L x 10 W)	Zinc	(2) #8-32 x 1in Truss Head Machine Screw (2) #8-32 x 1-1/2in Truss Head Machine Screw	N/A
BP36649BCRG10	Pull	Black Chrome/ Satin Nickel	5-1/16 (128) CTC	7-1/2 (191)	13/16 (21)	1-9/16 (40)	9/16 L x 3/8 W (14 L x 10 W)	Zinc	(2) #8-32 x 1in Truss Head Machine Screw (2) #8-32 x 1-1/2in Truss Head Machine Screw	N/A
BP36649G1026	Pull	Satin Nickel/ Polished Chrome	5-1/16 (128) CTC	7-1/2 (191)	13/16 (21)	1-9/16 (40)	9/16 L x 3/8 W (14 L x 10 W)	Zinc	(2) #8-32 x 1in Truss Head Machine Screw (2) #8-32 x 1-1/2in Truss Head Machine Screw	N/A
BP36649G10BCR	Pull	Satin Nickel/ Black Chrome	5-1/16 (128) CTC	7-1/2 (191)	13/16 (21)	1-9/16 (40)	9/16 L x 3/8 W (14 L x 10 W)	Zinc	(2) #8-32 x 1in Truss Head Machine Screw (2) #8-32 x 1-1/2in Truss Head Machine Screw	N/A
BP36649PNBBR	Pull	Polished Nickel/ Black Bronze	5-1/16 (128) CTC	7-1/2 (191)	13/16 (21)	1-9/16 (40)	9/16 L x 3/8 W (14 L x 10 W)	Zinc	(2) #8-32 x 1in Truss Head Machine Screw (2) #8-32 x 1-1/2in Truss Head Machine Screw	N/A
BP36649PNBCR	Pull	Polished Nickel/ Black Chrome	5-1/16 (128) CTC	7-1/2 (191)	13/16 (21)	1-9/16 (40)	9/16 L x 3/8 W (14 L x 10 W)	Zinc	(2) #8-32 x 1in Truss Head Machine Screw (2) #8-32 x 1-1/2in Truss Head Machine Screw	N/A
BP36650BBR26	Pull	Black Bronze/ Polished Chrome	6-5/16 (160) CTC	8-3/4 (222)	13/16 (21)	1-9/16 (40)	9/16 L x 3/8 W (14 L x 10 W)	Zinc	(2) #8-32 x 1in Truss Head Machine Screw (2) #8-32 x 1-1/2in Truss Head Machine Screw	N/A
BP36650BBRBBZ	Pull	Black Bronze/ Golden Champagne	6-5/16 (160) CTC	8-3/4 (222)	13/16 (21)	1-9/16 (40)	9/16 L x 3/8 W (14 L x 10 W)	Zinc	(2) #8-32 x 1in Truss Head Machine Screw (2) #8-32 x 1-1/2in Truss Head Machine Screw	N/A
BP36650BBRG10	Pull	Black Bronze/ Satin Nickel	6-5/16 (160) CTC	8-3/4 (222)	13/16 (21)	1-9/16 (40)	9/16 L x 3/8 W (14 L x 10 W)	Zinc	(2) #8-32 x 1in Truss Head Machine Screw (2) #8-32 x 1-1/2in Truss Head Machine Screw	N/A
BP36650BBZ26	Pull	Golden Champagne/ Polished Chrome	6-5/16 (160) CTC	8-3/4 (222)	13/16 (21)	1-9/16 (40)	9/16 L x 3/8 W (14 L x 10 W)	Zinc	(2) #8-32 x 1in Truss Head Machine Screw (2) #8-32 x 1-1/2in Truss Head Machine Screw	N/A
BP36650BBZBCR	Pull	Golden Champagne/ Black Chrome	6-5/16 (160) CTC	8-3/4 (222)	13/16 (21)	1-9/16 (40)	9/16 L x 3/8 W (14 L x 10 W)	Zinc	(2) #8-32 x 1in Truss Head Machine Screw (2) #8-32 x 1-1/2in Truss Head Machine Screw	N/A
BP36650BCR26	Pull	Black Chrome/ Polished Chrome	6-5/16 (160) CTC	8-3/4 (222)	13/16 (21)	1-9/16 (40)	9/16 L x 3/8 W (14 L x 10 W)	Zinc	(2) #8-32 x 1in Truss Head Machine Screw (2) #8-32 x 1-1/2in Truss Head Machine Screw	N/A
BP36650BCRBBZ	Pull	Black Chrome/ Golden Champagne	6-5/16 (160) CTC	8-3/4 (222)	13/16 (21)	1-9/16 (40)	9/16 L x 3/8 W (14 L x 10 W)	Zinc	(2) #8-32 x 1in Truss Head Machine Screw (2) #8-32 x 1-1/2in Truss Head Machine Screw	N/A
BP36650BCRG10	Pull	Black Chrome/ Satin Nickel	6-5/16 (160) CTC	8-3/4 (222)	13/16 (21)	1-9/16 (40)	9/16 L x 3/8 W (14 L x 10 W)	Zinc	(2) #8-32 x 1in Truss Head Machine Screw (2) #8-32 x 1-1/2in Truss Head Machine Screw	N/A
BP36650G1026	Pull	Satin Nickel/ Polished Chrome	6-5/16 (160) CTC	8-3/4 (222)	13/16 (21)	1-9/16 (40)	9/16 L x 3/8 W (14 L x 10 W)	Zinc	(2) #8-32 x 1in Truss Head Machine Screw (2) #8-32 x 1-1/2in Truss Head Machine Screw	N/A
BP36650G10BCR	Pull	Satin Nickel/ Black Chrome	6-5/16 (160) CTC	8-3/4 (222)	13/16 (21)	1-9/16 (40)	9/16 L x 3/8 W (14 L x 10 W)	Zinc	(2) #8-32 x 1in Truss Head Machine Screw (2) #8-32 x 1-1/2in Truss Head Machine Screw	N/A
BP36650PNBBR	Pull	Polished Nickel/ Black Bronze	6-5/16 (160) CTC	8-3/4 (222)	13/16 (21)	1-9/16 (40)	9/16 L x 3/8 W (14 L x 10 W)	Zinc	(2) #8-32 x 1in Truss Head Machine Screw (2) #8-32 x 1-1/2in Truss Head Machine Screw	N/A
BP36650PNBCR	Pull	Polished Nickel/ Black Chrome	6-5/16 (160) CTC	8-3/4 (222)	13/16 (21)	1-9/16 (40)	9/16 L x 3/8 W (14 L x 10 W)	Zinc	(2) #8-32 x 1in Truss Head Machine Screw (2) #8-32 x 1-1/2in Truss Head Machine Screw	N/A
BP36663BBR26	Pull	Black Bronze/ Polished Chrome	8 (203) CTC	10-7/16 (265)	13/16 (21)	1-9/16 (40)	9/16 L x 3/8 W (14 L x 10 W)	Zinc	(2) #8-32 x 1in Truss Head Machine Screw (2) #8-32 x 1-1/2in Truss Head Machine Screw	N/A
BP36663BBRBBZ	Pull	Black Bronze/ Golden Champagne	8 (203) CTC	10-7/16 (265)	13/16 (21)	1-9/16 (40)	9/16 L x 3/8 W (14 L x 10 W)	Zinc	(2) #8-32 x 1in Truss Head Machine Screw (2) #8-32 x 1-1/2in Truss Head Machine Screw	N/A
BP36663BBRG10	Pull	Black Bronze/ Satin Nickel	8 (203) CTC	10-7/16 (265)	13/16 (21)	1-9/16 (40)	9/16 L x 3/8 W (14 L x 10 W)	Zinc	(2) #8-32 x 1in Truss Head Machine Screw (2) #8-32 x 1-1/2in Truss Head Machine Screw	N/A
BP36663BBZ26	Pull	Golden Champagne/ Polished Chrome	8 (203) CTC	10-7/16 (265)	13/16 (21)	1-9/16 (40)	9/16 L x 3/8 W (14 L x 10 W)	Zinc	(2) #8-32 x 1in Truss Head Machine Screw (2) #8-32 x 1-1/2in Truss Head Machine Screw	N/A
BP36663BBZBCR	Pull	Golden Champagne/ Black Chrome	8 (203) CTC	10-7/16 (265)	13/16 (21)	1-9/16 (40)	9/16 L x 3/8 W (14 L x 10 W)	Zinc	(2) #8-32 x 1in Truss Head Machine Screw (2) #8-32 x 1-1/2in Truss Head Machine Screw	N/A
BP36663BCR26	Pull	Black Chrome/ Polished Chrome	8 (203) CTC	10-7/16 (265)	13/16 (21)	1-9/16 (40)	9/16 L x 3/8 W (14 L x 10 W)	Zinc	(2) #8-32 x 1in Truss Head Machine Screw (2) #8-32 x 1-1/2in Truss Head Machine Screw	N/A
BP36663BCRBBZ	Pull	Black Chrome/ Golden Champagne	8 (203) CTC	10-7/16 (265)	13/16 (21)	1-9/16 (40)	9/16 L x 3/8 W (14 L x 10 W)	Zinc	(2) #8-32 x 1in Truss Head Machine Screw (2) #8-32 x 1-1/2in Truss Head Machine Screw	N/A

Mounting hardware included.  
The dimensional information provided here should be verified with the actual product prior to drilling or attempting to install the hardware.  
Please direct any questions you may have on the installation process to Amerock Customer Service (see back cover for contact information).

# PRODUCT INDEX

Product No.	Type	Finish	Product Detail in (mm)	Length in (mm)	Width in (mm)	Projection in (mm)	Base Dimensions in (mm)	Base Material	Mounting Hardware Included	ADA-Friendly
<b>London (continued) • p. 52</b>										
BP36663BCRG10	Pull	Black Chrome/ Satin Nickel	8 (203) CTC	10-7/16 (265)	13/16 (21)	1-9/16 (40)	9/16 L x 3/8 W (14 L x 10 W)	Zinc	(2) #8-32 x 1in Truss Head Machine Screw (2) #8-32 x 1-1/2in Truss Head Machine Screw	N/A
BP36663G1026	Pull	Satin Nickel/ Polished Chrome	8 (203) CTC	10-7/16 (265)	13/16 (21)	1-9/16 (40)	9/16 L x 3/8 W (14 L x 10 W)	Zinc	(2) #8-32 x 1in Truss Head Machine Screw (2) #8-32 x 1-1/2in Truss Head Machine Screw	N/A
BP36663G10BCR	Pull	Satin Nickel/ Black Chrome	8 (203) CTC	10-7/16 (265)	13/16 (21)	1-9/16 (40)	9/16 L x 3/8 W (14 L x 10 W)	Zinc	(2) #8-32 x 1in Truss Head Machine Screw (2) #8-32 x 1-1/2in Truss Head Machine Screw	N/A
BP36663PNBBR	Pull	Polished Nickel/ Black Bronze	8 (203) CTC	10-7/16 (265)	13/16 (21)	1-9/16 (40)	9/16 L x 3/8 W (14 L x 10 W)	Zinc	(2) #8-32 x 1in Truss Head Machine Screw (2) #8-32 x 1-1/2in Truss Head Machine Screw	N/A
BP36663PNBCR	Pull	Polished Nickel/ Black Chrome	8 (203) CTC	10-7/16 (265)	13/16 (21)	1-9/16 (40)	9/16 L x 3/8 W (14 L x 10 W)	Zinc	(2) #8-32 x 1in Truss Head Machine Screw (2) #8-32 x 1-1/2in Truss Head Machine Screw	N/A
BP36664BBR26	Pull	Black Bronze/ Polished Chrome	10-1/16 (256) CTC	12-1/2 (318)	13/16 (21)	1-9/16 (40)	9/16 L x 3/8 W (14 L x 10 W)	Zinc	(2) #8-32 x 1in Truss Head Machine Screw (2) #8-32 x 1-1/2in Truss Head Machine Screw	N/A
BP36664BBRBBZ	Pull	Black Bronze/ Golden Champagne	10-1/16 (256) CTC	12-1/2 (318)	13/16 (21)	1-9/16 (40)	9/16 L x 3/8 W (14 L x 10 W)	Zinc	(2) #8-32 x 1in Truss Head Machine Screw (2) #8-32 x 1-1/2in Truss Head Machine Screw	N/A
BP36664BBRG10	Pull	Black Bronze/ Satin Nickel	10-1/16 (256) CTC	12-1/2 (318)	13/16 (21)	1-9/16 (40)	9/16 L x 3/8 W (14 L x 10 W)	Zinc	(2) #8-32 x 1in Truss Head Machine Screw (2) #8-32 x 1-1/2in Truss Head Machine Screw	N/A
BP36664BBZ26	Pull	Golden Champagne/ Polished Chrome	10-1/16 (256) CTC	12-1/2 (318)	13/16 (21)	1-9/16 (40)	9/16 L x 3/8 W (14 L x 10 W)	Zinc	(2) #8-32 x 1in Truss Head Machine Screw (2) #8-32 x 1-1/2in Truss Head Machine Screw	N/A
BP36664BBZBCR	Pull	Golden Champagne/ Black Chrome	10-1/16 (256) CTC	12-1/2 (318)	13/16 (21)	1-9/16 (40)	9/16 L x 3/8 W (14 L x 10 W)	Zinc	(2) #8-32 x 1in Truss Head Machine Screw (2) #8-32 x 1-1/2in Truss Head Machine Screw	N/A
BP36664BCR26	Pull	Black Chrome/ Polished Chrome	10-1/16 (256) CTC	12-1/2 (318)	13/16 (21)	1-9/16 (40)	9/16 L x 3/8 W (14 L x 10 W)	Zinc	(2) #8-32 x 1in Truss Head Machine Screw (2) #8-32 x 1-1/2in Truss Head Machine Screw	N/A
BP36664BCRBBZ	Pull	Black Chrome/ Golden Champagne	10-1/16 (256) CTC	12-1/2 (318)	13/16 (21)	1-9/16 (40)	9/16 L x 3/8 W (14 L x 10 W)	Zinc	(2) #8-32 x 1in Truss Head Machine Screw (2) #8-32 x 1-1/2in Truss Head Machine Screw	N/A
BP36664BCRG10	Pull	Black Chrome/ Satin Nickel	10-1/16 (256) CTC	12-1/2 (318)	13/16 (21)	1-9/16 (40)	9/16 L x 3/8 W (14 L x 10 W)	Zinc	(2) #8-32 x 1in Truss Head Machine Screw (2) #8-32 x 1-1/2in Truss Head Machine Screw	N/A
BP36664G1026	Pull	Satin Nickel/ Polished Chrome	10-1/16 (256) CTC	12-1/2 (318)	13/16 (21)	1-9/16 (40)	9/16 L x 3/8 W (14 L x 10 W)	Zinc	(2) #8-32 x 1in Truss Head Machine Screw (2) #8-32 x 1-1/2in Truss Head Machine Screw	N/A
BP36664G10BCR	Pull	Satin Nickel/ Black Chrome	10-1/16 (256) CTC	12-1/2 (318)	13/16 (21)	1-9/16 (40)	9/16 L x 3/8 W (14 L x 10 W)	Zinc	(2) #8-32 x 1in Truss Head Machine Screw (2) #8-32 x 1-1/2in Truss Head Machine Screw	N/A
BP36664PNBBR	Pull	Polished Nickel/ Black Bronze	10-1/16 (256) CTC	12-1/2 (318)	13/16 (21)	1-9/16 (40)	9/16 L x 3/8 W (14 L x 10 W)	Zinc	(2) #8-32 x 1in Truss Head Machine Screw (2) #8-32 x 1-1/2in Truss Head Machine Screw	N/A
BP36664PNBCR	Pull	Polished Nickel/ Black Chrome	10-1/16 (256) CTC	12-1/2 (318)	13/16 (21)	1-9/16 (40)	9/16 L x 3/8 W (14 L x 10 W)	Zinc	(2) #8-32 x 1in Truss Head Machine Screw (2) #8-32 x 1-1/2in Truss Head Machine Screw	N/A
<b>Esquire • p. 54</b>										
BA26613G10ORB	Robe Hook	Satin Nickel/ Oil-Rubbed Bronze	Double	4-1/2 (114)	1-1/16 (27)	2-9/16 (65)	2-11/16 L x 1-5/8 W (68 L x 41 W)	Zinc/ Stainless Steel	(2) #8 x 1-1/4 in. Sheet Metal Screw (1) Mounting Bracket	N/A
BA26613PNBBR	Robe Hook	Polished Nickel/ Black Bronze	Double	4-1/2 (114)	1-1/16 (27)	2-9/16 (65)	2-11/16 L x 1-5/8 W (68 L x 41 W)	Zinc/ Stainless Steel	(2) #8 x 1-1/4 in. Sheet Metal Screw (1) Mounting Bracket	N/A
BA26613PNBBZ	Robe Hook	Polished Nickel/ Golden Champagne	Double	4-1/2 (114)	1-1/16 (27)	2-9/16 (65)	2-11/16 L x 1-5/8 W (68 L x 41 W)	Zinc/ Stainless Steel	(2) #8 x 1-1/4 in. Sheet Metal Screw (1) Mounting Bracket	N/A
BA26613PNGM	Robe Hook	Polished Nickel/ Gunmetal	Double	4-1/2 (114)	1-1/16 (27)	2-9/16 (65)	2-11/16 L x 1-5/8 W (68 L x 41 W)	Zinc/ Stainless Steel	(2) #8 x 1-1/4 in. Sheet Metal Screw (1) Mounting Bracket	N/A
BA26613PNSS	Robe Hook	Polished Nickel/ Stainless Steel	Double	4-1/2 (114)	1-1/16 (27)	2-9/16 (65)	2-11/16 L x 1-5/8 W (68 L x 41 W)	Zinc/ Stainless Steel	(2) #8 x 1-1/4 in. Sheet Metal Screw (1) Mounting Bracket	N/A
BH36563G10ORB	Robe Hook	Brushed Nickel/ Oil-Rubbed Bronze	Single	2-11/16 (68)	5/8 (16)	2-1/4 (57)	1-7/8 L x 1-7/8 W (48 L x 48 W)	Zinc/ Stainless Steel	(2) #8 x 1-1/4 in. Sheet Metal Screw (1) Mounting Bracket	N/A
BH36563PNBBR	Robe Hook	Polished Nickel/ Black Bronze	Single	2-11/16 (68)	5/8 (16)	2-1/4 (57)	1-7/8 L x 1-7/8 W (48 L x 48 W)	Zinc/ Stainless Steel	(2) #8 x 1-1/4 in. Sheet Metal Screw (1) Mounting Bracket	N/A

Mounting hardware included.  
The dimensional information provided here should be verified with the actual product prior to drilling or attempting to install the hardware.  
Please direct any questions you may have on the installation process to Amerock Customer Service (see back cover for contact information).

# PRODUCT INDEX

Product No.	Type	Finish	Product Detail in (mm)	Length in (mm)	Width in (mm)	Projection in (mm)	Base Dimensions in (mm)	Base Material	Mounting Hardware Included	ADA-Friendly
<b>Esquire (continued) • p. 54</b>										
BH36563PNBBZ	Robe Hook	Polished Nickel/ Golden Champagne	Single	2-11/16 (68)	5/8 (16)	2-1/4 (57)	1-7/8 L x 1-7/8 W (48 L x 48 W)	Zinc/ Stainless Steel	(2) #8 x 1-1/4 in. Sheet Metal Screw (1) Mounting Bracket	N/A
BH36563PNGM	Robe Hook	Polished Nickel/ Gunmetal	Single	2-11/16 (68)	5/8 (16)	2-1/4 (57)	1-7/8 L x 1-7/8 W (48 L x 48 W)	Zinc/ Stainless Steel	(2) #8 x 1-1/4 in. Sheet Metal Screw (1) Mounting Bracket	N/A
BH36563PNSS	Robe Hook	Polished Nickel/ Stainless Steel	Single	2-11/16 (68)	5/8 (16)	2-1/4 (57)	1-7/8 L x 1-7/8 W (48 L x 48 W)	Zinc/ Stainless Steel	(2) #8 x 1-1/4 in. Sheet Metal Screw (1) Mounting Bracket	N/A
BP36556G1OORB	Knob	Satin Nickel/ Oil-Rubbed Bronze	2-5/8 (67) LGTH	2-5/8 (67)	5/8 (16)	1-1/2 (38)	5/8 L x 7/16 W (16 L x 11 W)	Zinc/ Stainless Steel	(1) #8-32 x 1in Truss Head Machine Screw (1) #8-32 x 1-1/2in Truss Head Machine Screw	N/A
BP36556PNBBR	Knob	Polished Nickel/ Black Bronze	2-5/8 (67) LGTH	2-5/8 (67)	5/8 (16)	1-1/2 (38)	5/8 L x 7/16 W (16 L x 11 W)	Zinc/ Stainless Steel	(1) #8-32 x 1in Truss Head Machine Screw (1) #8-32 x 1-1/2in Truss Head Machine Screw	N/A
BP36556PNBBZ	Knob	Polished Nickel/ Golden Champagne	2-5/8 (67) LGTH	2-5/8 (67)	5/8 (16)	1-1/2 (38)	5/8 L x 7/16 W (16 L x 11 W)	Zinc/ Stainless Steel	(1) #8-32 x 1in Truss Head Machine Screw (1) #8-32 x 1-1/2in Truss Head Machine Screw	N/A
BP36556PNGM	Knob	Polished Nickel/ Gunmetal	2-5/8 (67) LGTH	2-5/8 (67)	5/8 (16)	1-1/2 (38)	5/8 L x 7/16 W (16 L x 11 W)	Zinc/ Stainless Steel	(1) #8-32 x 1in Truss Head Machine Screw (1) #8-32 x 1-1/2in Truss Head Machine Screw	N/A
BP36556PNSS	Knob	Polished Nickel/ Stainless Steel	2-5/8 (67) LGTH	2-5/8 (67)	5/8 (16)	1-1/2 (38)	5/8 L x 7/16 W (16 L x 11 W)	Zinc/ Stainless Steel	(1) #8-32 x 1in Truss Head Machine Screw (1) #8-32 x 1-1/2in Truss Head Machine Screw	N/A
BP36557G1OORB	Pull	Satin Nickel/ Oil-Rubbed Bronze	3 & 3-3/4 (76 & 96) CTC	4-11/16 (119)	5/8 (16)	1-1/2 (38)	11/16 L x 3/8 W (17 L x 10 W)	Zinc/ Stainless Steel	(2) #8-32 x 1in Truss Head Machine Screw (2) #8-32 x 1-1/2in Truss Head Machine Screw	N/A
BP36557PNBBR	Pull	Polished Nickel/ Black Bronze	3 & 3-3/4 (76 & 96) CTC	4-11/16 (119)	5/8 (16)	1-1/2 (38)	11/16 L x 3/8 W (17 L x 10 W)	Zinc/ Stainless Steel	(2) #8-32 x 1in Truss Head Machine Screw (2) #8-32 x 1-1/2in Truss Head Machine Screw	N/A
BP36557PNBBZ	Pull	Polished Nickel/ Golden Champagne	3 & 3-3/4 (76 & 96) CTC	4-11/16 (119)	5/8 (16)	1-1/2 (38)	11/16 L x 3/8 W (17 L x 10 W)	Zinc/ Stainless Steel	(2) #8-32 x 1in Truss Head Machine Screw (2) #8-32 x 1-1/2in Truss Head Machine Screw	N/A
BP36557PNGM	Pull	Polished Nickel/ Gunmetal	3 & 3-3/4 (76 & 96) CTC	4-11/16 (119)	5/8 (16)	1-1/2 (38)	11/16 L x 3/8 W (17 L x 10 W)	Zinc/ Stainless Steel	(2) #8-32 x 1in Truss Head Machine Screw (2) #8-32 x 1-1/2in Truss Head Machine Screw	N/A
BP36557PNSS	Pull	Polished Nickel/ Stainless Steel	3 & 3-3/4 (76 & 96) CTC	4-11/16 (119)	5/8 (16)	1-1/2 (38)	11/16 L x 3/8 W (17 L x 10 W)	Zinc/ Stainless Steel	(2) #8-32 x 1in Truss Head Machine Screw (2) #8-32 x 1-1/2in Truss Head Machine Screw	N/A
BP36558G1OORB	Pull	Satin Nickel/ Oil-Rubbed Bronze	5-1/16 (128) CTC	5-15/16 (151)	5/8 (16)	1-1/2 (38)	11/16 L x 3/8 W (17 L x 10 W)	Zinc/ Stainless Steel	(2) #8-32 x 1in Truss Head Machine Screw (2) #8-32 x 1-1/2in Truss Head Machine Screw	N/A
BP36558PNBBR	Pull	Polished Nickel/ Black Bronze	5-1/16 (128) CTC	5-15/16 (151)	5/8 (16)	1-1/2 (38)	11/16 L x 3/8 W (17 L x 10 W)	Zinc/ Stainless Steel	(2) #8-32 x 1in Truss Head Machine Screw (2) #8-32 x 1-1/2in Truss Head Machine Screw	N/A
BP36558PNBBZ	Pull	Polished Nickel/ Golden Champagne	5-1/16 (128) CTC	5-15/16 (151)	5/8 (16)	1-1/2 (38)	11/16 L x 3/8 W (17 L x 10 W)	Zinc/ Stainless Steel	(2) #8-32 x 1in Truss Head Machine Screw (2) #8-32 x 1-1/2in Truss Head Machine Screw	N/A
BP36558PNGM	Pull	Polished Nickel/ Gunmetal	5-1/16 (128) CTC	5-15/16 (151)	5/8 (16)	1-1/2 (38)	11/16 L x 3/8 W (17 L x 10 W)	Zinc/ Stainless Steel	(2) #8-32 x 1in Truss Head Machine Screw (2) #8-32 x 1-1/2in Truss Head Machine Screw	N/A
BP36558PNSS	Pull	Polished Nickel/ Stainless Steel	5-1/16 (128) CTC	5-15/16 (151)	5/8 (16)	1-1/2 (38)	11/16 L x 3/8 W (17 L x 10 W)	Zinc/ Stainless Steel	(2) #8-32 x 1in Truss Head Machine Screw (2) #8-32 x 1-1/2in Truss Head Machine Screw	N/A
BP36559G1OORB	Pull	Satin Nickel/ Oil-Rubbed Bronze	6-5/16 (160) CTC	7-3/16 (183)	5/8 (16)	1-1/2 (38)	11/16 L x 3/8 W (17 L x 10 W)	Zinc/ Stainless Steel	(2) #8-32 x 1in Truss Head Machine Screw (2) #8-32 x 1-1/2in Truss Head Machine Screw	N/A
BP36559PNBBR	Pull	Polished Nickel/ Black Bronze	6-5/16 (160) CTC	7-3/16 (183)	5/8 (16)	1-1/2 (38)	11/16 L x 3/8 W (17 L x 10 W)	Zinc/ Stainless Steel	(2) #8-32 x 1in Truss Head Machine Screw (2) #8-32 x 1-1/2in Truss Head Machine Screw	N/A
BP36559PNBBZ	Pull	Polished Nickel/ Golden Champagne	6-5/16 (160) CTC	7-3/16 (183)	5/8 (16)	1-1/2 (38)	11/16 L x 3/8 W (17 L x 10 W)	Zinc/ Stainless Steel	(2) #8-32 x 1in Truss Head Machine Screw (2) #8-32 x 1-1/2in Truss Head Machine Screw	N/A
BP36559PNGM	Pull	Polished Nickel/ Gunmetal	6-5/16 (160) CTC	7-3/16 (183)	5/8 (16)	1-1/2 (38)	11/16 L x 3/8 W (17 L x 10 W)	Zinc/ Stainless Steel	(2) #8-32 x 1in Truss Head Machine Screw (2) #8-32 x 1-1/2in Truss Head Machine Screw	N/A
BP36559PNSS	Pull	Polished Nickel/ Stainless Steel	6-5/16 (160) CTC	7-3/16 (183)	5/8 (16)	1-1/2 (38)	11/16 L x 3/8 W (17 L x 10 W)	Zinc/ Stainless Steel	(2) #8-32 x 1in Truss Head Machine Screw (2) #8-32 x 1-1/2in Truss Head Machine Screw	N/A
BP36560G1OORB	Pull	Satin Nickel/ Oil-Rubbed Bronze	10-1/16 (256) CTC	11 (279)	5/8 (16)	1-1/2 (38)	11/16 L x 3/8 W (17 L x 10 W)	Zinc/ Stainless Steel	(2) #8-32 x 1in Truss Head Machine Screw (2) #8-32 x 1-1/2in Truss Head Machine Screw	N/A
BP36560PNBBR	Pull	Polished Nickel/ Black Bronze	10-1/16 (256) CTC	11 (279)	5/8 (16)	1-1/2 (38)	11/16 L x 3/8 W (17 L x 10 W)	Zinc/ Stainless Steel	(2) #8-32 x 1in Truss Head Machine Screw (2) #8-32 x 1-1/2in Truss Head Machine Screw	N/A

Mounting hardware included.  
The dimensional information provided here should be verified with the actual product prior to drilling or attempting to install the hardware.  
Please direct any questions you may have on the installation process to Amerock Customer Service (see back cover for contact information).



# PRODUCT INDEX

Product No.	Type	Finish	Product Detail in (mm)	Length in (mm)	Width in (mm)	Projection in (mm)	Base Dimensions in (mm)	Base Material	Mounting Hardware Included	ADA-Friendly
<b>Esquire (continued) • p. 54</b>										
BP36560PNBBZ	Pull	Polished Nickel/ Golden Champagne	10-1/16 (256) CTC	11 (279)	5/8 (16)	1-1/2 (38)	11/16 L x 3/8 W (17 L x 10 W)	Zinc/ Stainless Steel	(2) #8-32 x 1in Truss Head Machine Screw (2) #8-32 x 1-1/2in Truss Head Machine Screw	N/A
BP36560PNGM	Pull	Polished Nickel/ Gunmetal	10-1/16 (256) CTC	11 (279)	5/8 (16)	1-1/2 (38)	11/16 L x 3/8 W (17 L x 10 W)	Zinc/ Stainless Steel	(2) #8-32 x 1in Truss Head Machine Screw (2) #8-32 x 1-1/2in Truss Head Machine Screw	N/A
BP36560PNSS	Pull	Polished Nickel/ Stainless Steel	10-1/16 (256) CTC	11 (279)	5/8 (16)	1-1/2 (38)	11/16 L x 3/8 W (17 L x 10 W)	Zinc/ Stainless Steel	(2) #8-32 x 1in Truss Head Machine Screw (2) #8-32 x 1-1/2in Truss Head Machine Screw	N/A
BP36561G1OORB	Pull	Satin Nickel/ Oil-Rubbed Bronze	12-5/8 (320) CTC	13-1/2 (343)	5/8 (16)	1-1/2 (38)	11/16 L x 3/8 W (17 L x 10 W)	Zinc/ Stainless Steel	(2) #8-32 x 1in Truss Head Machine Screw (2) #8-32 x 1-1/2in Truss Head Machine Screw	N/A
BP36561PNBBR	Pull	Polished Nickel/ Black Bronze	12-5/8 (320) CTC	13-1/2 (343)	5/8 (16)	1-1/2 (38)	11/16 L x 3/8 W (17 L x 10 W)	Zinc/ Stainless Steel	(2) #8-32 x 1in Truss Head Machine Screw (2) #8-32 x 1-1/2in Truss Head Machine Screw	N/A
BP36561PNBBZ	Pull	Polished Nickel/ Golden Champagne	12-5/8 (320) CTC	13-1/2 (343)	5/8 (16)	1-1/2 (38)	11/16 L x 3/8 W (17 L x 10 W)	Zinc/ Stainless Steel	(2) #8-32 x 1in Truss Head Machine Screw (2) #8-32 x 1-1/2in Truss Head Machine Screw	N/A
BP36561PNGM	Pull	Polished Nickel/ Gunmetal	12-5/8 (320) CTC	13-1/2 (343)	5/8 (16)	1-1/2 (38)	11/16 L x 3/8 W (17 L x 10 W)	Zinc/ Stainless Steel	(2) #8-32 x 1in Truss Head Machine Screw (2) #8-32 x 1-1/2in Truss Head Machine Screw	N/A
BP36561PNSS	Pull	Polished Nickel/ Stainless Steel	12-5/8 (320) CTC	13-1/2 (343)	5/8 (16)	1-1/2 (38)	11/16 L x 3/8 W (17 L x 10 W)	Zinc/ Stainless Steel	(2) #8-32 x 1in Truss Head Machine Screw (2) #8-32 x 1-1/2in Truss Head Machine Screw	N/A
BP36562G1OORB	Pull	Satin Nickel/ Oil-Rubbed Bronze	8 (203) CTC	8-7/8 (225)	5/8 (16)	1-1/2 (38)	11/16 L x 3/8 W (17 L x 10 W)	Zinc/ Stainless Steel	(2) #8-32 x 1in Truss Head Machine Screw (2) #8-32 x 1-1/2in Truss Head Machine Screw	N/A
BP36562PNBBR	Pull	Polished Nickel/ Black Bronze	8 (203) CTC	8-7/8 (225)	5/8 (16)	1-1/2 (38)	11/16 L x 3/8 W (17 L x 10 W)	Zinc/ Stainless Steel	(2) #8-32 x 1in Truss Head Machine Screw (2) #8-32 x 1-1/2in Truss Head Machine Screw	N/A
BP36562PNBBZ	Pull	Polished Nickel/ Golden Champagne	8 (203) CTC	8-7/8 (225)	5/8 (16)	1-1/2 (38)	11/16 L x 3/8 W (17 L x 10 W)	Zinc/ Stainless Steel	(2) #8-32 x 1in Truss Head Machine Screw (2) #8-32 x 1-1/2in Truss Head Machine Screw	N/A
BP36562PNGM	Pull	Polished Nickel/ Gunmetal	8 (203) CTC	8-7/8 (225)	5/8 (16)	1-1/2 (38)	11/16 L x 3/8 W (17 L x 10 W)	Zinc/ Stainless Steel	(2) #8-32 x 1in Truss Head Machine Screw (2) #8-32 x 1-1/2in Truss Head Machine Screw	N/A
BP36562PNSS	Pull	Polished Nickel/ Stainless Steel	8 (203) CTC	8-7/8 (225)	5/8 (16)	1-1/2 (38)	11/16 L x 3/8 W (17 L x 10 W)	Zinc/ Stainless Steel	(2) #8-32 x 1in Truss Head Machine Screw (2) #8-32 x 1-1/2in Truss Head Machine Screw	N/A
<b>Bronx • p. 56</b>										
BH36563BBR	Robe Hook	Black Bronze	Single	2-11/16 (68)	5/8 (16)	2-1/4 (57)	1-7/8 L x 1-7/8 W (48 L x 48 W)	Zinc/ Stainless Steel	(2) #8 x 1-1/4 in. Sheet Metal Screw (1) Mounting Bracket	N/A
BH36563BBZ	Robe Hook	Golden Champagne	Single	2-11/16 (68)	5/8 (16)	2-1/4 (57)	1-7/8 L x 1-7/8 W (48 L x 48 W)	Zinc/ Stainless Steel	(2) #8 x 1-1/4 in. Sheet Metal Screw (1) Mounting Bracket	N/A
BH36563G10	Robe Hook	Satin Nickel	Single	2-11/16 (68)	5/8 (16)	2-1/4 (57)	1-7/8 L x 1-7/8 W (48 L x 48 W)	Zinc/ Stainless Steel	(2) #8 x 1-1/4 in. Sheet Metal Screw (1) Mounting Bracket	N/A
BH36563GM	Robe Hook	Gunmetal	Single	2-11/16 (68)	5/8 (16)	2-1/4 (57)	1-7/8 L x 1-7/8 W (48 L x 48 W)	Zinc/ Stainless Steel	(2) #8 x 1-1/4 in. Sheet Metal Screw (1) Mounting Bracket	N/A
BH36563ORB	Robe Hook	Oil-Rubbed Bronze	Single	2-11/16 (68)	5/8 (16)	2-1/4 (57)	1-7/8 L x 1-7/8 W (48 L x 48 W)	Zinc/ Stainless Steel	(2) #8 x 1-1/4 in. Sheet Metal Screw (1) Mounting Bracket	N/A
BH36563PN	Robe Hook	Polished Nickel	Single	2-11/16 (68)	5/8 (16)	2-1/4 (57)	1-7/8 L x 1-7/8 W (48 L x 48 W)	Zinc/ Stainless Steel	(2) #8 x 1-1/4 in. Sheet Metal Screw (1) Mounting Bracket	N/A
BP36556BBR	Knob	Black Bronze	2-5/8 (67) LGTH	2-5/8 (67)	5/8 (16)	1-1/2 (38)	5/8 L x 7/16 W (16 L x 11 W)	Zinc/ Stainless Steel	(1) #8-32 x 1in Truss Head Machine Screw (1) #8-32 x 1-1/2in Truss Head Machine Screw	N/A
BP36556BBZ	Knob	Golden Champagne	2-5/8 (67) LGTH	2-5/8 (67)	5/8 (16)	1-1/2 (38)	5/8 L x 7/16 W (16 L x 11 W)	Zinc/ Stainless Steel	(1) #8-32 x 1in Truss Head Machine Screw (1) #8-32 x 1-1/2in Truss Head Machine Screw	N/A
BP36556G10	Knob	Satin Nickel	2-5/8 (67) LGTH	2-5/8 (67)	5/8 (16)	1-1/2 (38)	5/8 L x 7/16 W (16 L x 11 W)	Zinc/ Stainless Steel	(1) #8-32 x 1in Truss Head Machine Screw (1) #8-32 x 1-1/2in Truss Head Machine Screw	N/A
BP36556GM	Knob	Gunmetal	2-5/8 (67) LGTH	2-5/8 (67)	5/8 (16)	1-1/2 (38)	5/8 L x 7/16 W (16 L x 11 W)	Zinc/ Stainless Steel	(1) #8-32 x 1in Truss Head Machine Screw (1) #8-32 x 1-1/2in Truss Head Machine Screw	N/A
BP36556ORB	Knob	Oil-Rubbed Bronze	2-5/8 (67) LGTH	2-5/8 (67)	5/8 (16)	1-1/2 (38)	5/8 L x 7/16 W (16 L x 11 W)	Zinc/ Stainless Steel	(1) #8-32 x 1in Truss Head Machine Screw (1) #8-32 x 1-1/2in Truss Head Machine Screw	N/A

Mounting hardware included.  
The dimensional information provided here should be verified with the actual product prior to drilling or attempting to install the hardware.  
Please direct any questions you may have on the installation process to Amerock Customer Service (see back cover for contact information).

# PRODUCT INDEX

Product No.	Type	Finish	Product Detail in (mm)	Length in (mm)	Width in (mm)	Projection in (mm)	Base Dimensions in (mm)	Base Material	Mounting Hardware Included	ADA-Friendly
<b>Bronx (continued) • p. 56</b>										
BP36556PN	Knob	Polished Nickel	2-5/8 (67) LGTH	2-5/8 (67)	5/8 (16)	1-1/2 (38)	5/8 L x 7/16 W (16 L x 11 W)	Zinc/ Stainless Steel	(1) #8-32 x 1in Truss Head Machine Screw (1) #8-32 x 1-1/2in Truss Head Machine Screw	N/A
BP36557BBR	Pull	Black Bronze	3 & 3-3/4 (76 & 96) CTC	4-11/16 (119)	5/8 (16)	1-1/2 (38)	11/16 L x 3/8 W (17 L x 10 W)	Zinc/ Stainless Steel	(2) #8-32 x 1in Truss Head Machine Screw (2) #8-32 x 1-1/2in Truss Head Machine Screw	N/A
BP36557BBZ	Pull	Golden Champagne	3 & 3-3/4 (76 & 96) CTC	4-11/16 (119)	5/8 (16)	1-1/2 (38)	11/16 L x 3/8 W (17 L x 10 W)	Zinc/ Stainless Steel	(2) #8-32 x 1in Truss Head Machine Screw (2) #8-32 x 1-1/2in Truss Head Machine Screw	N/A
BP36557G10	Pull	Satin Nickel	3 & 3-3/4 (76 & 96) CTC	4-11/16 (119)	5/8 (16)	1-1/2 (38)	11/16 L x 3/8 W (17 L x 10 W)	Zinc/ Stainless Steel	(2) #8-32 x 1in Truss Head Machine Screw (2) #8-32 x 1-1/2in Truss Head Machine Screw	N/A
BP36557GM	Pull	Gunmetal	3 & 3-3/4 (76 & 96) CTC	4-11/16 (119)	5/8 (16)	1-1/2 (38)	11/16 L x 3/8 W (17 L x 10 W)	Zinc/ Stainless Steel	(2) #8-32 x 1in Truss Head Machine Screw (2) #8-32 x 1-1/2in Truss Head Machine Screw	N/A
BP36557ORB	Pull	Oil-Rubbed Bronze	3 & 3-3/4 (76 & 96) CTC	4-11/16 (119)	5/8 (16)	1-1/2 (38)	11/16 L x 3/8 W (17 L x 10 W)	Zinc/ Stainless Steel	(2) #8-32 x 1in Truss Head Machine Screw (2) #8-32 x 1-1/2in Truss Head Machine Screw	N/A
BP36557PN	Pull	Polished Nickel	3 & 3-3/4 (76 & 96) CTC	4-11/16 (119)	5/8 (16)	1-1/2 (38)	11/16 L x 3/8 W (17 L x 10 W)	Zinc/ Stainless Steel	(2) #8-32 x 1in Truss Head Machine Screw (2) #8-32 x 1-1/2in Truss Head Machine Screw	N/A
BP36558BBR	Pull	Black Bronze	5-1/16 (128) CTC	5-15/16 (151)	5/8 (16)	1-1/2 (38)	11/16 L x 3/8 W (17 L x 10 W)	Zinc/ Stainless Steel	(2) #8-32 x 1in Truss Head Machine Screw (2) #8-32 x 1-1/2in Truss Head Machine Screw	N/A
BP36558BBZ	Pull	Golden Champagne	5-1/16 (128) CTC	5-15/16 (151)	5/8 (16)	1-1/2 (38)	11/16 L x 3/8 W (17 L x 10 W)	Zinc/ Stainless Steel	(2) #8-32 x 1in Truss Head Machine Screw (2) #8-32 x 1-1/2in Truss Head Machine Screw	N/A
BP36558G10	Pull	Satin Nickel	5-1/16 (128) CTC	5-15/16 (151)	5/8 (16)	1-1/2 (38)	11/16 L x 3/8 W (17 L x 10 W)	Zinc/ Stainless Steel	(2) #8-32 x 1in Truss Head Machine Screw (2) #8-32 x 1-1/2in Truss Head Machine Screw	N/A
BP36558GM	Pull	Gunmetal	5-1/16 (128) CTC	5-15/16 (151)	5/8 (16)	1-1/2 (38)	11/16 L x 3/8 W (17 L x 10 W)	Zinc/ Stainless Steel	(2) #8-32 x 1in Truss Head Machine Screw (2) #8-32 x 1-1/2in Truss Head Machine Screw	N/A
BP36558ORB	Pull	Oil-Rubbed Bronze	5-1/16 (128) CTC	5-15/16 (151)	5/8 (16)	1-1/2 (38)	11/16 L x 3/8 W (17 L x 10 W)	Zinc/ Stainless Steel	(2) #8-32 x 1in Truss Head Machine Screw (2) #8-32 x 1-1/2in Truss Head Machine Screw	N/A
BP36558PN	Pull	Polished Nickel	5-1/16 (128) CTC	5-15/16 (151)	5/8 (16)	1-1/2 (38)	11/16 L x 3/8 W (17 L x 10 W)	Zinc/ Stainless Steel	(2) #8-32 x 1in Truss Head Machine Screw (2) #8-32 x 1-1/2in Truss Head Machine Screw	N/A
BP36559BBR	Pull	Black Bronze	6-5/16 (160) CTC	7-3/16 (183)	5/8 (16)	1-1/2 (38)	11/16 L x 3/8 W (17 L x 10 W)	Zinc/ Stainless Steel	(2) #8-32 x 1in Truss Head Machine Screw (2) #8-32 x 1-1/2in Truss Head Machine Screw	N/A
BP36559BBZ	Pull	Golden Champagne	6-5/16 (160) CTC	7-3/16 (183)	5/8 (16)	1-1/2 (38)	11/16 L x 3/8 W (17 L x 10 W)	Zinc/ Stainless Steel	(2) #8-32 x 1in Truss Head Machine Screw (2) #8-32 x 1-1/2in Truss Head Machine Screw	N/A
BP36559G10	Pull	Satin Nickel	6-5/16 (160) CTC	7-3/16 (183)	5/8 (16)	1-1/2 (38)	11/16 L x 3/8 W (17 L x 10 W)	Zinc/ Stainless Steel	(2) #8-32 x 1in Truss Head Machine Screw (2) #8-32 x 1-1/2in Truss Head Machine Screw	N/A
BP36559GM	Pull	Gunmetal	6-5/16 (160) CTC	7-3/16 (183)	5/8 (16)	1-1/2 (38)	11/16 L x 3/8 W (17 L x 10 W)	Zinc/ Stainless Steel	(2) #8-32 x 1in Truss Head Machine Screw (2) #8-32 x 1-1/2in Truss Head Machine Screw	N/A
BP36559ORB	Pull	Oil-Rubbed Bronze	6-5/16 (160) CTC	7-3/16 (183)	5/8 (16)	1-1/2 (38)	11/16 L x 3/8 W (17 L x 10 W)	Zinc/ Stainless Steel	(2) #8-32 x 1in Truss Head Machine Screw (2) #8-32 x 1-1/2in Truss Head Machine Screw	N/A
BP36559PN	Pull	Polished Nickel	6-5/16 (160) CTC	7-3/16 (183)	5/8 (16)	1-1/2 (38)	11/16 L x 3/8 W (17 L x 10 W)	Zinc/ Stainless Steel	(2) #8-32 x 1in Truss Head Machine Screw (2) #8-32 x 1-1/2in Truss Head Machine Screw	N/A
BP36560BBR	Pull	Black Bronze	10-1/16 (256) CTC	11 (279)	5/8 (16)	1-1/2 (38)	11/16 L x 3/8 W (17 L x 10 W)	Zinc/ Stainless Steel	(2) #8-32 x 1in Truss Head Machine Screw (2) #8-32 x 1-1/2in Truss Head Machine Screw	N/A
BP36560BBZ	Pull	Golden Champagne	10-1/16 (256) CTC	11 (279)	5/8 (16)	1-1/2 (38)	11/16 L x 3/8 W (17 L x 10 W)	Zinc/ Stainless Steel	(2) #8-32 x 1in Truss Head Machine Screw (2) #8-32 x 1-1/2in Truss Head Machine Screw	N/A
BP36560G10	Pull	Satin Nickel	10-1/16 (256) CTC	11 (279)	5/8 (16)	1-1/2 (38)	11/16 L x 3/8 W (17 L x 10 W)	Zinc/ Stainless Steel	(2) #8-32 x 1in Truss Head Machine Screw (2) #8-32 x 1-1/2in Truss Head Machine Screw	N/A
BP36560GM	Pull	Gunmetal	10-1/16 (256) CTC	11 (279)	5/8 (16)	1-1/2 (38)	11/16 L x 3/8 W (17 L x 10 W)	Zinc/ Stainless Steel	(2) #8-32 x 1in Truss Head Machine Screw (2) #8-32 x 1-1/2in Truss Head Machine Screw	N/A
BP36560ORB	Pull	Oil-Rubbed Bronze	10-1/16 (256) CTC	11 (279)	5/8 (16)	1-1/2 (38)	11/16 L x 3/8 W (17 L x 10 W)	Zinc/ Stainless Steel	(2) #8-32 x 1in Truss Head Machine Screw (2) #8-32 x 1-1/2in Truss Head Machine Screw	N/A
BP36560PN	Pull	Polished Nickel	10-1/16 (256) CTC	11 (279)	5/8 (16)	1-1/2 (38)	11/16 L x 3/8 W (17 L x 10 W)	Zinc/ Stainless Steel	(2) #8-32 x 1in Truss Head Machine Screw (2) #8-32 x 1-1/2in Truss Head Machine Screw	N/A

Mounting hardware included.  
The dimensional information provided here should be verified with the actual product prior to drilling or attempting to install the hardware.  
Please direct any questions you may have on the installation process to Amerock Customer Service (see back cover for contact information).

# PRODUCT INDEX

Product No.	Type	Finish	Product Detail in (mm)	Length in (mm)	Width in (mm)	Projection in (mm)	Base Dimensions in (mm)	Base Material	Mounting Hardware Included	ADA-Friendly
<b>Bronx (continued) • p. 56</b>										
BP36561BBR	Pull	Black Bronze	12-5/8 (320) CTC	13-1/2 (343)	5/8 (16)	1-1/2 (38)	11/16 L x 3/8 W (17 L x 10 W)	Zinc/ Stainless Steel	(2) #8-32 x 1in Truss Head Machine Screw (2) #8-32 x 1-1/2in Truss Head Machine Screw	N/A
BP36561BBZ	Pull	Golden Champagne	12-5/8 (320) CTC	13-1/2 (343)	5/8 (16)	1-1/2 (38)	11/16 L x 3/8 W (17 L x 10 W)	Zinc/ Stainless Steel	(2) #8-32 x 1in Truss Head Machine Screw (2) #8-32 x 1-1/2in Truss Head Machine Screw	N/A
BP36561G10	Pull	Satin Nickel	12-5/8 (320) CTC	13-1/2 (343)	5/8 (16)	1-1/2 (38)	11/16 L x 3/8 W (17 L x 10 W)	Zinc/ Stainless Steel	(2) #8-32 x 1in Truss Head Machine Screw (2) #8-32 x 1-1/2in Truss Head Machine Screw	N/A
BP36561GM	Pull	Gunmetal	12-5/8 (320) CTC	13-1/2 (343)	5/8 (16)	1-1/2 (38)	11/16 L x 3/8 W (17 L x 10 W)	Zinc/ Stainless Steel	(2) #8-32 x 1in Truss Head Machine Screw (2) #8-32 x 1-1/2in Truss Head Machine Screw	N/A
BP36561ORB	Pull	Oil-Rubbed Bronze	12-5/8 (320) CTC	13-1/2 (343)	5/8 (16)	1-1/2 (38)	11/16 L x 3/8 W (17 L x 10 W)	Zinc/ Stainless Steel	(2) #8-32 x 1in Truss Head Machine Screw (2) #8-32 x 1-1/2in Truss Head Machine Screw	N/A
BP36561PN	Pull	Polished Nickel	12-5/8 (320) CTC	13-1/2 (343)	5/8 (16)	1-1/2 (38)	11/16 L x 3/8 W (17 L x 10 W)	Zinc/ Stainless Steel	(2) #8-32 x 1in Truss Head Machine Screw (2) #8-32 x 1-1/2in Truss Head Machine Screw	N/A
BP36562BBR	Pull	Black Bronze	8 (203) CTC	8-7/8 (225)	5/8 (16)	1-1/2 (38)	11/16 L x 3/8 W (17 L x 10 W)	Zinc/ Stainless Steel	(2) #8-32 x 1in Truss Head Machine Screw (2) #8-32 x 1-1/2in Truss Head Machine Screw	N/A
BP36562BBZ	Pull	Golden Champagne	8 (203) CTC	8-7/8 (225)	5/8 (16)	1-1/2 (38)	11/16 L x 3/8 W (17 L x 10 W)	Zinc/ Stainless Steel	(2) #8-32 x 1in Truss Head Machine Screw (2) #8-32 x 1-1/2in Truss Head Machine Screw	N/A
BP36562G10	Pull	Satin Nickel	8 (203) CTC	8-7/8 (225)	5/8 (16)	1-1/2 (38)	11/16 L x 3/8 W (17 L x 10 W)	Zinc/ Stainless Steel	(2) #8-32 x 1in Truss Head Machine Screw (2) #8-32 x 1-1/2in Truss Head Machine Screw	N/A
BP36562GM	Pull	Gunmetal	8 (203) CTC	8-7/8 (225)	5/8 (16)	1-1/2 (38)	11/16 L x 3/8 W (17 L x 10 W)	Zinc/ Stainless Steel	(2) #8-32 x 1in Truss Head Machine Screw (2) #8-32 x 1-1/2in Truss Head Machine Screw	N/A
BP36562ORB	Pull	Oil-Rubbed Bronze	8 (203) CTC	8-7/8 (225)	5/8 (16)	1-1/2 (38)	11/16 L x 3/8 W (17 L x 10 W)	Zinc/ Stainless Steel	(2) #8-32 x 1in Truss Head Machine Screw (2) #8-32 x 1-1/2in Truss Head Machine Screw	N/A
BP36562PN	Pull	Polished Nickel	8 (203) CTC	8-7/8 (225)	5/8 (16)	1-1/2 (38)	11/16 L x 3/8 W (17 L x 10 W)	Zinc/ Stainless Steel	(2) #8-32 x 1in Truss Head Machine Screw (2) #8-32 x 1-1/2in Truss Head Machine Screw	N/A
<b>Oberon • p. 58</b>										
BP36603BBZ	Knob	Golden Champagne	1-3/8 (35) DIA	1-3/8 (35)	N/A	1-3/16 (30)	11/16 L x 11/16 W (17 L x 17 W)	Zinc	(1) #8-32 x 1in Truss Head Machine Screw (1) #8-32 x 1-1/2in Truss Head Machine Screw	N/A
BP36603G10	Knob	Satin Nickel	1-3/8 (35) DIA	1-3/8 (35)	N/A	1-3/16 (30)	11/16 L x 11/16 W (17 L x 17 W)	Zinc	(1) #8-32 x 1in Truss Head Machine Screw (1) #8-32 x 1-1/2in Truss Head Machine Screw	N/A
BP36603GM	Knob	Gunmetal	1-3/8 (35) DIA	1-3/8 (35)	N/A	1-3/16 (30)	11/16 L x 11/16 W (17 L x 17 W)	Zinc	(1) #8-32 x 1in Truss Head Machine Screw (1) #8-32 x 1-1/2in Truss Head Machine Screw	N/A
BP36603MB	Knob	Matte Black	1-3/8 (35) DIA	1-3/8 (35)	N/A	1-3/16 (30)	11/16 L x 11/16 W (17 L x 17 W)	Zinc	(1) #8-32 x 1in Truss Head Machine Screw (1) #8-32 x 1-1/2in Truss Head Machine Screw	N/A
BP36603PN	Knob	Polished Nickel	1-3/8 (35) DIA	1-3/8 (35)	N/A	1-3/16 (30)	11/16 L x 11/16 W (17 L x 17 W)	Zinc	(1) #8-32 x 1in Truss Head Machine Screw (1) #8-32 x 1-1/2in Truss Head Machine Screw	N/A
BP36604BBZ	Knob	Golden Champagne	1-3/4 (44) DIA	1-3/4 (44)	N/A	1-5/16 (33)	3/4 L x 3/4 W (19 L x 19 W)	Zinc	(1) #8-32 x 1in Truss Head Machine Screw (1) #8-32 x 1-1/2in Truss Head Machine Screw	N/A
BP36604G10	Knob	Satin Nickel	1-3/4 (44) DIA	1-3/4 (44)	N/A	1-5/16 (33)	3/4 L x 3/4 W (19 L x 19 W)	Zinc	(1) #8-32 x 1in Truss Head Machine Screw (1) #8-32 x 1-1/2in Truss Head Machine Screw	N/A
BP36604GM	Knob	Gunmetal	1-3/4 (44) DIA	1-3/4 (44)	N/A	1-5/16 (33)	3/4 L x 3/4 W (19 L x 19 W)	Zinc	(1) #8-32 x 1in Truss Head Machine Screw (1) #8-32 x 1-1/2in Truss Head Machine Screw	N/A
BP36604PN	Knob	Polished Nickel	1-3/4 (44) DIA	1-3/4 (44)	N/A	1-5/16 (33)	3/4 L x 3/4 W (19 L x 19 W)	Zinc	(1) #8-32 x 1in Truss Head Machine Screw (1) #8-32 x 1-1/2in Truss Head Machine Screw	N/A
BP36608BBZFA	Knob	Golden Champagne/ Frosted	1-3/8 (35) DIA	1-3/8 (35)	N/A	1-3/16 (30)	5/8 L x 5/8 W (16 L x 16 W)	Zinc/Acrylic	(1) #8-32 x 1in Truss Head Machine Screw (1) #8-32 x 1-1/2in Truss Head Machine Screw	N/A
BP36608G10FA	Knob	Satin Nickel/Frosted	1-3/8 (35) DIA	1-3/8 (35)	N/A	1-3/16 (30)	5/8 L x 5/8 W (16 L x 16 W)	Zinc/Acrylic	(1) #8-32 x 1in Truss Head Machine Screw (1) #8-32 x 1-1/2in Truss Head Machine Screw	N/A
BP36608GMFA	Knob	Gunmetal/Frosted	1-3/8 (35) DIA	1-3/8 (35)	N/A	1-3/16 (30)	5/8 L x 5/8 W (16 L x 16 W)	Zinc/Acrylic	(1) #8-32 x 1in Truss Head Machine Screw (1) #8-32 x 1-1/2in Truss Head Machine Screw	N/A

Mounting hardware included.  
The dimensional information provided here should be verified with the actual product prior to drilling or attempting to install the hardware.  
Please direct any questions you may have on the installation process to Amerock Customer Service (see back cover for contact information).

# PRODUCT INDEX

Product No.	Type	Finish	Product Detail in (mm)	Length in (mm)	Width in (mm)	Projection in (mm)	Base Dimensions in (mm)	Base Material	Mounting Hardware Included	ADA-Friendly
<b>Oberon (continued) • p. 58</b>										
BP36608MBFA	Knob	Matte Black/ Frosted	1-3/8 (35) DIA	1-3/8 (35)	N/A	1-3/16 (30)	5/8 L x 5/8 W (16 L x 16 W)	Zinc/Acrylic	(1) #8-32 x 1in Truss Head Machine Screw (1) #8-32 x 1-1/2in Truss Head Machine Screw	N/A
BP36608PNFA	Knob	Polished Nickel/ Frosted	1-3/8 (35) DIA	1-3/8 (35)	N/A	1-3/16 (30)	5/8 L x 5/8 W (16 L x 16 W)	Zinc/Acrylic	(1) #8-32 x 1in Truss Head Machine Screw (1) #8-32 x 1-1/2in Truss Head Machine Screw	N/A
BP36609BBZFA	Knob	Golden Champagne/ Frosted	1-3/4 (44) DIA	1-3/4 (44)	N/A	1-5/16 (33)	3/4 L x 3/4 W (19 L x 19 W)	Zinc/Acrylic	(1) #8-32 x 1in Truss Head Machine Screw (1) #8-32 x 1-1/2in Truss Head Machine Screw	N/A
BP36609G10FA	Knob	Satin Nickel/ Frosted	1-3/4 (44) DIA	1-3/4 (44)	N/A	1-5/16 (33)	3/4 L x 3/4 W (19 L x 19 W)	Zinc/Acrylic	(1) #8-32 x 1in Truss Head Machine Screw (1) #8-32 x 1-1/2in Truss Head Machine Screw	N/A
BP36609GMFA	Knob	Gunmetal/Frosted	1-3/4 (44) DIA	1-3/4 (44)	N/A	1-5/16 (33)	3/4 L x 3/4 W (19 L x 19 W)	Zinc/Acrylic	(1) #8-32 x 1in Truss Head Machine Screw (1) #8-32 x 1-1/2in Truss Head Machine Screw	N/A
BP36609PNFA	Knob	Polished Nickel/ Frosted	1-3/4 (44) DIA	1-3/4 (44)	N/A	1-5/16 (33)	3/4 L x 3/4 W (19 L x 19 W)	Zinc/Acrylic	(1) #8-32 x 1in Truss Head Machine Screw (1) #8-32 x 1-1/2in Truss Head Machine Screw	N/A
<b>Concentric • p. 60</b>										
BP36810BBZ	Knob	Golden Champagne	1-9/16 (40) DIA	1-9/16 (40)	N/A	3/4 (19)	3/8 L x 3/8 W (10 L x 10 W)	Zinc	(1) #8-32 x 1in Truss Head Machine Screw (1) #8-32 x 1-1/2in Truss Head Machine Screw	N/A
BP36810G10	Knob	Satin Nickel	1-9/16 (40) DIA	1-9/16 (40)	N/A	3/4 (19)	3/8 L x 3/8 W (10 L x 10 W)	Zinc	(1) #8-32 x 1in Truss Head Machine Screw (1) #8-32 x 1-1/2in Truss Head Machine Screw	N/A
BP36810GM	Knob	Gunmetal	1-9/16 (40) DIA	1-9/16 (40)	N/A	3/4 (19)	3/8 L x 3/8 W (10 L x 10 W)	Zinc	(1) #8-32 x 1in Truss Head Machine Screw (1) #8-32 x 1-1/2in Truss Head Machine Screw	N/A
BP36810MB	Knob	Matte Black	1-9/16 (40) DIA	1-9/16 (40)	N/A	3/4 (19)	3/8 L x 3/8 W (10 L x 10 W)	Zinc	(1) #8-32 x 1in Truss Head Machine Screw (1) #8-32 x 1-1/2in Truss Head Machine Screw	N/A
BP36810PN	Knob	Polished Nickel	1-9/16 (40) DIA	1-9/16 (40)	N/A	3/4 (19)	3/8 L x 3/8 W (10 L x 10 W)	Zinc	(1) #8-32 x 1in Truss Head Machine Screw (1) #8-32 x 1-1/2in Truss Head Machine Screw	N/A
BP36811BBZ	Finger Pull	Golden Champagne	1-1/4 (32) CTC	1-11/16 (43)	N/A	7/8 (22)	5/16 L x 1 W (8 L x 25 W)	Zinc	(2) #8-32 x 1in Truss Head Machine Screw (2) #8-32 x 1-1/2in Truss Head Machine Screw	N/A
BP36811G10	Finger Pull	Satin Nickel	1-1/4 (32) CTC	1-11/16 (43)	1 (25)	7/8 (22)	5/16 L x 1 W (8 L x 25 W)	Zinc	(2) #8-32 x 1in Truss Head Machine Screw (2) #8-32 x 1-1/2in Truss Head Machine Screw	N/A
BP36811GM	Finger Pull	Gunmetal	1-1/4 (32) CTC	1-11/16 (43)	1 (25)	7/8 (22)	5/16 L x 1 W (8 L x 25 W)	Zinc	(2) #8-32 x 1in Truss Head Machine Screw (2) #8-32 x 1-1/2in Truss Head Machine Screw	N/A
BP36811MB	Finger Pull	Matte Black	1-1/4 (32) CTC	1-11/16 (43)	1 (25)	7/8 (22)	5/16 L x 1 W (8 L x 25 W)	Zinc	(2) #8-32 x 1in Truss Head Machine Screw (2) #8-32 x 1-1/2in Truss Head Machine Screw	N/A
BP36811PN	Finger Pull	Polished Nickel	1-1/4 (32) CTC	1-11/16 (43)	1 (25)	7/8 (22)	5/16 L x 1 W (8 L x 25 W)	Zinc	(2) #8-32 x 1in Truss Head Machine Screw (2) #8-32 x 1-1/2in Truss Head Machine Screw	N/A
BP36812BBZ	Pull	Golden Champagne	3-3/4 (96) CTC	4-3/16 (106)	1 (25)	7/8 (22)	5/16 L x 1 W (8 L x 25 W)	Zinc	(2) #8-32 x 1in Truss Head Machine Screw (2) #8-32 x 1-1/2in Truss Head Machine Screw	N/A
BP36812G10	Pull	Satin Nickel	3-3/4 (96) CTC	4-3/16 (106)	1 (25)	7/8 (22)	5/16 L x 1 W (8 L x 25 W)	Zinc	(2) #8-32 x 1in Truss Head Machine Screw (2) #8-32 x 1-1/2in Truss Head Machine Screw	N/A
BP36812GM	Pull	Gunmetal	3-3/4 (96) CTC	4-3/16 (106)	1 (25)	7/8 (22)	5/16 L x 1 W (8 L x 25 W)	Zinc	(2) #8-32 x 1in Truss Head Machine Screw (2) #8-32 x 1-1/2in Truss Head Machine Screw	N/A
BP36812MB	Pull	Matte Black	3-3/4 (96) CTC	4-3/16 (106)	1 (25)	7/8 (22)	5/16 L x 1 W (8 L x 25 W)	Zinc	(2) #8-32 x 1in Truss Head Machine Screw (2) #8-32 x 1-1/2in Truss Head Machine Screw	N/A
BP36812PN	Pull	Polished Nickel	3-3/4 (96) CTC	4-3/16 (106)	1 (25)	7/8 (22)	5/16 L x 1 W (8 L x 25 W)	Zinc	(2) #8-32 x 1in Truss Head Machine Screw (2) #8-32 x 1-1/2in Truss Head Machine Screw	N/A
BP36813BBZ	Pull	Golden Champagne	5-1/16 (128) CTC	5-7/16 (138)	1 (25)	7/8 (22)	5/16 L x 1 W (8 L x 25 W)	Zinc	(2) #8-32 x 1in Truss Head Machine Screw (2) #8-32 x 1-1/2in Truss Head Machine Screw	N/A
BP36813G10	Pull	Satin Nickel	5-1/16 (128) CTC	5-7/16 (138)	1 (25)	7/8 (22)	5/16 L x 1 W (8 L x 25 W)	Zinc	(2) #8-32 x 1in Truss Head Machine Screw (2) #8-32 x 1-1/2in Truss Head Machine Screw	N/A

Mounting hardware included.  
The dimensional information provided here should be verified with the actual product prior to drilling or attempting to install the hardware.  
Please direct any questions you may have on the installation process to Amerock Customer Service (see back cover for contact information).

# PRODUCT INDEX

Product No.	Type	Finish	Product Detail in (mm)	Length in (mm)	Width in (mm)	Projection in (mm)	Base Dimensions in (mm)	Base Material	Mounting Hardware Included	ADA-Friendly
<b>Concentric (continued) • p. 60</b>										
BP36813GM	Pull	Gunmetal	5-1/16 (128) CTC	5-7/16 (138)	1 (25)	7/8 (22)	5/16 L x 1 W (8 L x 25 W)	Zinc	(2) #8-32 x 1in Truss Head Machine Screw (2) #8-32 x 1-1/2in Truss Head Machine Screw	N/A
BP36813MB	Pull	Matte Black	5-1/16 (128) CTC	5-7/16 (138)	1 (25)	7/8 (22)	5/16 L x 1 W (8 L x 25 W)	Zinc	(2) #8-32 x 1in Truss Head Machine Screw (2) #8-32 x 1-1/2in Truss Head Machine Screw	N/A
BP36813PN	Pull	Polished Nickel	5-1/16 (128) CTC	5-7/16 (138)	1 (25)	7/8 (22)	5/16 L x 1 W (8 L x 25 W)	Zinc	(2) #8-32 x 1in Truss Head Machine Screw (2) #8-32 x 1-1/2in Truss Head Machine Screw	N/A
BP36814BBZ	Pull	Golden Champagne	6-5/16 (160) CTC	6-11/16 (170)	1 (25)	7/8 (22)	5/16 L x 1 W (8 L x 25 W)	Zinc	(2) #8-32 x 1in Truss Head Machine Screw (2) #8-32 x 1-1/2in Truss Head Machine Screw	N/A
BP36814G10	Pull	Satin Nickel	6-5/16 (160) CTC	6-11/16 (170)	1 (25)	7/8 (22)	5/16 L x 1 W (8 L x 25 W)	Zinc	(2) #8-32 x 1in Truss Head Machine Screw (2) #8-32 x 1-1/2in Truss Head Machine Screw	N/A
BP36814GM	Pull	Gunmetal	6-5/16 (160) CTC	6-11/16 (170)	1 (25)	7/8 (22)	5/16 L x 1 W (8 L x 25 W)	Zinc	(2) #8-32 x 1in Truss Head Machine Screw (2) #8-32 x 1-1/2in Truss Head Machine Screw	N/A
BP36814MB	Pull	Matte Black	6-5/16 (160) CTC	6-11/16 (170)	1 (25)	7/8 (22)	5/16 L x 1 W (8 L x 25 W)	Zinc	(2) #8-32 x 1in Truss Head Machine Screw (2) #8-32 x 1-1/2in Truss Head Machine Screw	N/A
BP36814PN	Pull	Polished Nickel	6-5/16 (160) CTC	6-11/16 (170)	1 (25)	7/8 (22)	5/16 L x 1 W (8 L x 25 W)	Zinc	(2) #8-32 x 1in Truss Head Machine Screw (2) #8-32 x 1-1/2in Truss Head Machine Screw	N/A
BP36815BBZ	Pull	Golden Champagne	7-9/16 (192) CTC	7-15/16 (202)	1 (25)	7/8 (22)	5/16 L x 1 W (8 L x 25 W)	Zinc	(2) #8-32 x 1in Truss Head Machine Screw (2) #8-32 x 1-1/2in Truss Head Machine Screw	N/A
BP36815G10	Pull	Satin Nickel	7-9/16 (192) CTC	7-15/16 (202)	1 (25)	7/8 (22)	5/16 L x 1 W (8 L x 25 W)	Zinc	(2) #8-32 x 1in Truss Head Machine Screw (2) #8-32 x 1-1/2in Truss Head Machine Screw	N/A
BP36815GM	Pull	Gunmetal	7-9/16 (192) CTC	7-15/16 (202)	1 (25)	7/8 (22)	5/16 L x 1 W (8 L x 25 W)	Zinc	(2) #8-32 x 1in Truss Head Machine Screw (2) #8-32 x 1-1/2in Truss Head Machine Screw	N/A
BP36815MB	Pull	Matte Black	7-9/16 (192) CTC	7-15/16 (202)	1 (25)	7/8 (22)	5/16 L x 1 W (8 L x 25 W)	Zinc	(2) #8-32 x 1in Truss Head Machine Screw (2) #8-32 x 1-1/2in Truss Head Machine Screw	N/A
BP36815PN	Pull	Polished Nickel	7-9/16 (192) CTC	7-15/16 (202)	1 (25)	7/8 (22)	5/16 L x 1 W (8 L x 25 W)	Zinc	(2) #8-32 x 1in Truss Head Machine Screw (2) #8-32 x 1-1/2in Truss Head Machine Screw	N/A
BP36816BBZ	Pull	Golden Champagne	10-1/16 (256) CTC	10-7/16 (265)	1 (25)	7/8 (22)	5/16 L x 1 W (8 L x 25 W)	Zinc	(2) #8-32 x 1in Truss Head Machine Screw (2) #8-32 x 1-1/2in Truss Head Machine Screw	N/A
BP36816G10	Pull	Satin Nickel	10-1/16 (256) CTC	10-7/16 (265)	1 (25)	7/8 (22)	5/16 L x 1 W (8 L x 25 W)	Zinc	(2) #8-32 x 1in Truss Head Machine Screw (2) #8-32 x 1-1/2in Truss Head Machine Screw	N/A
BP36816GM	Pull	Gunmetal	10-1/16 (256) CTC	10-7/16 (265)	1 (25)	7/8 (22)	5/16 L x 1 W (8 L x 25 W)	Zinc	(2) #8-32 x 1in Truss Head Machine Screw (2) #8-32 x 1-1/2in Truss Head Machine Screw	N/A
BP36816MB	Pull	Matte Black	10-1/16 (256) CTC	10-7/16 (265)	1 (25)	7/8 (22)	5/16 L x 1 W (8 L x 25 W)	Zinc	(2) #8-32 x 1in Truss Head Machine Screw (2) #8-32 x 1-1/2in Truss Head Machine Screw	N/A
BP36816PN	Pull	Polished Nickel	10-1/16 (256) CTC	10-7/16 (265)	1 (25)	7/8 (22)	5/16 L x 1 W (8 L x 25 W)	Zinc	(2) #8-32 x 1in Truss Head Machine Screw (2) #8-32 x 1-1/2in Truss Head Machine Screw	N/A
BP36830BBZ	Pull	Golden Champagne	3-3/4 (96) CTC	4-1/2 (114)	11/16 (17)	15/16 (24)	5/16 L x 5/16 W (8 L x 8 W)	Zinc	(2) #8-32 x 1in Truss Head Machine Screw (2) #8-32 x 1-1/2in Truss Head Machine Screw	N/A
BP36830G10	Pull	Satin Nickel	3-3/4 (96) CTC	4-1/2 (114)	11/16 (17)	15/16 (24)	5/16 L x 5/16 W (8 L x 8 W)	Zinc	(2) #8-32 x 1in Truss Head Machine Screw (2) #8-32 x 1-1/2in Truss Head Machine Screw	N/A
BP36830GM	Pull	Gunmetal	3-3/4 (96) CTC	4-1/2 (114)	11/16 (17)	15/16 (24)	5/16 L x 5/16 W (8 L x 8 W)	Zinc	(2) #8-32 x 1in Truss Head Machine Screw (2) #8-32 x 1-1/2in Truss Head Machine Screw	N/A
BP36830MB	Pull	Matte Black	3-3/4 (96) CTC	4-1/2 (114)	11/16 (17)	15/16 (24)	5/16 L x 5/16 W (8 L x 8 W)	Zinc	(2) #8-32 x 1in Truss Head Machine Screw (2) #8-32 x 1-1/2in Truss Head Machine Screw	N/A
BP36830PN	Pull	Polished Nickel	3-3/4 (96) CTC	4-1/2 (114)	11/16 (17)	15/16 (24)	5/16 L x 5/16 W (8 L x 8 W)	Zinc	(2) #8-32 x 1in Truss Head Machine Screw (2) #8-32 x 1-1/2in Truss Head Machine Screw	N/A
BP36831BBZ	Pull	Golden Champagne	5-1/16 (128) CTC	5-3/4 (146)	11/16 (17)	15/16 (24)	5/16 L x 5/16 W (8 L x 8 W)	Zinc	(2) #8-32 x 1in Truss Head Machine Screw (2) #8-32 x 1-1/2in Truss Head Machine Screw	N/A
BP36831G10	Pull	Satin Nickel	5-1/16 (128) CTC	5-3/4 (146)	11/16 (17)	15/16 (24)	5/16 L x 5/16 W (8 L x 8 W)	Zinc	(2) #8-32 x 1in Truss Head Machine Screw (2) #8-32 x 1-1/2in Truss Head Machine Screw	N/A

Mounting hardware included.

The dimensional information provided here should be verified with the actual product prior to drilling or attempting to install the hardware. Please direct any questions you may have on the installation process to Amerock Customer Service (see back cover for contact information).

# PRODUCT INDEX

Product No.	Type	Finish	Product Detail in (mm)	Length in (mm)	Width in (mm)	Projection in (mm)	Base Dimensions in (mm)	Base Material	Mounting Hardware Included	ADA-Friendly
<b>Concentric (continued) • p. 60</b>										
BP36831GM	Pull	Gunmetal	5-1/16 (128) CTC	5-3/4 (146)	1/16 (17)	15/16 (24)	5/16 L x 5/16 W (8 L x 8 W)	Zinc	(2) #8-32 x 1in Truss Head Machine Screw (2) #8-32 x 1-1/2in Truss Head Machine Screw	N/A
BP36831MB	Pull	Matte Black	5-1/16 (128) CTC	5-3/4 (146)	1/16 (17)	15/16 (24)	5/16 L x 5/16 W (8 L x 8 W)	Zinc	(2) #8-32 x 1in Truss Head Machine Screw (2) #8-32 x 1-1/2in Truss Head Machine Screw	N/A
BP36831PN	Pull	Polished Nickel	5-1/16 (128) CTC	5-3/4 (146)	1/16 (17)	15/16 (24)	5/16 L x 5/16 W (8 L x 8 W)	Zinc	(2) #8-32 x 1in Truss Head Machine Screw (2) #8-32 x 1-1/2in Truss Head Machine Screw	N/A
BP36832BBZ	Pull	Golden Champagne	6-5/16 (160) CTC	7 (178)	1/16 (17)	15/16 (24)	5/16 L x 5/16 W (8 L x 8 W)	Zinc	(2) #8-32 x 1in Truss Head Machine Screw (2) #8-32 x 1-1/2in Truss Head Machine Screw	N/A
BP36832G10	Pull	Satin Nickel	6-5/16 (160) CTC	7 (178)	1/16 (17)	15/16 (24)	5/16 L x 5/16 W (8 L x 8 W)	Zinc	(2) #8-32 x 1in Truss Head Machine Screw (2) #8-32 x 1-1/2in Truss Head Machine Screw	N/A
BP36832GM	Pull	Gunmetal	6-5/16 (160) CTC	7 (178)	1/16 (17)	15/16 (24)	5/16 L x 5/16 W (8 L x 8 W)	Zinc	(2) #8-32 x 1in Truss Head Machine Screw (2) #8-32 x 1-1/2in Truss Head Machine Screw	N/A
BP36832MB	Pull	Matte Black	6-5/16 (160) CTC	7 (178)	1/16 (17)	15/16 (24)	5/16 L x 5/16 W (8 L x 8 W)	Zinc	(2) #8-32 x 1in Truss Head Machine Screw (2) #8-32 x 1-1/2in Truss Head Machine Screw	N/A
BP36832PN	Pull	Polished Nickel	6-5/16 (160) CTC	7 (178)	1/16 (17)	15/16 (24)	5/16 L x 5/16 W (8 L x 8 W)	Zinc	(2) #8-32 x 1in Truss Head Machine Screw (2) #8-32 x 1-1/2in Truss Head Machine Screw	N/A
BP36833BBZ	Pull	Golden Champagne	7-9/16 (192) CTC	8-1/4 (210)	1/16 (17)	15/16 (24)	5/16 L x 5/16 W (8 L x 8 W)	Zinc	(2) #8-32 x 1in Truss Head Machine Screw (2) #8-32 x 1-1/2in Truss Head Machine Screw	N/A
BP36833G10	Pull	Satin Nickel	7-9/16 (192) CTC	8-1/4 (210)	1/16 (17)	15/16 (24)	5/16 L x 5/16 W (8 L x 8 W)	Zinc	(2) #8-32 x 1in Truss Head Machine Screw (2) #8-32 x 1-1/2in Truss Head Machine Screw	N/A
BP36833GM	Pull	Gunmetal	7-9/16 (192) CTC	8-1/4 (210)	1/16 (17)	15/16 (24)	5/16 L x 5/16 W (8 L x 8 W)	Zinc	(2) #8-32 x 1in Truss Head Machine Screw (2) #8-32 x 1-1/2in Truss Head Machine Screw	N/A
BP36833MB	Pull	Matte Black	7-9/16 (192) CTC	8-1/4 (210)	1/16 (17)	15/16 (24)	5/16 L x 5/16 W (8 L x 8 W)	Zinc	(2) #8-32 x 1in Truss Head Machine Screw (2) #8-32 x 1-1/2in Truss Head Machine Screw	N/A
BP36833PN	Pull	Polished Nickel	7-9/16 (192) CTC	8-1/4 (210)	1/16 (17)	15/16 (24)	5/16 L x 5/16 W (8 L x 8 W)	Zinc	(2) #8-32 x 1in Truss Head Machine Screw (2) #8-32 x 1-1/2in Truss Head Machine Screw	N/A
BP36834BBZ	Pull	Golden Champagne	10-1/16 (256) CTC	10-3/4 (273)	1/16 (17)	15/16 (24)	5/16 L x 5/16 W (8 L x 8 W)	Zinc	(2) #8-32 x 1in Truss Head Machine Screw (2) #8-32 x 1-1/2in Truss Head Machine Screw	N/A
BP36834G10	Pull	Satin Nickel	10-1/16 (256) CTC	10-3/4 (273)	1/16 (17)	15/16 (24)	5/16 L x 5/16 W (8 L x 8 W)	Zinc	(2) #8-32 x 1in Truss Head Machine Screw (2) #8-32 x 1-1/2in Truss Head Machine Screw	N/A
BP36834GM	Pull	Gunmetal	10-1/16 (256) CTC	10-3/4 (273)	1/16 (17)	15/16 (24)	5/16 L x 5/16 W (8 L x 8 W)	Zinc	(2) #8-32 x 1in Truss Head Machine Screw (2) #8-32 x 1-1/2in Truss Head Machine Screw	N/A
BP36834MB	Pull	Matte Black	10-1/16 (256) CTC	10-3/4 (273)	1/16 (17)	15/16 (24)	5/16 L x 5/16 W (8 L x 8 W)	Zinc	(2) #8-32 x 1in Truss Head Machine Screw (2) #8-32 x 1-1/2in Truss Head Machine Screw	N/A
BP36834PN	Pull	Polished Nickel	10-1/16 (256) CTC	10-3/4 (273)	1/16 (17)	15/16 (24)	5/16 L x 5/16 W (8 L x 8 W)	Zinc	(2) #8-32 x 1in Truss Head Machine Screw (2) #8-32 x 1-1/2in Truss Head Machine Screw	N/A
<b>Calathea • p. 62</b>										
BP100312826	Pull	Polished Chrome	5-1/16 (128) CTC	5-11/16 (144)	1-1/16 (27)	1-1/16 (27)	1/2 L x 1-1/16 W (13 L x 27 W)	Zinc	(2) M4 X 1in Truss Head Machine Screw (2) M4 X 1-9/16in Truss Head Machine Screw	N/A
BP1003128BCR	Pull	Black Chrome	5-1/16 (128) CTC	5-11/16 (144)	1-1/16 (27)	1-1/16 (27)	1/2 L x 1-1/16 W (13 L x 27 W)	Zinc	(2) M4 X 1in Truss Head Machine Screw (2) M4 X 1-9/16in Truss Head Machine Screw	N/A
BP1003128BGL	Pull	Brushed Gold	5-1/16 (128) CTC	5-11/16 (144)	1-1/16 (27)	1-1/16 (27)	1/2 L x 1-1/16 W (13 L x 27 W)	Zinc	(2) M4 X 1in Truss Head Machine Screw (2) M4 X 1-9/16in Truss Head Machine Screw	N/A
BP1003128G10	Pull	Satin Nickel	5-1/16 (128) CTC	5-11/16 (144)	1-1/16 (27)	1-1/16 (27)	1/2 L x 1-1/16 W (13 L x 27 W)	Zinc	(2) M4 X 1in Truss Head Machine Screw (2) M4 X 1-9/16in Truss Head Machine Screw	N/A
BP1003128MB	Pull	Matte Black	5-1/16 (128) CTC	5-11/16 (144)	1-1/16 (27)	1-1/16 (27)	1/2 L x 1-1/16 W (13 L x 27 W)	Zinc	(2) M4 X 1in Truss Head Machine Screw (2) M4 X 1-9/16in Truss Head Machine Screw	N/A

Mounting hardware included.  
The dimensional information provided here should be verified with the actual product prior to drilling or attempting to install the hardware.  
Please direct any questions you may have on the installation process to Amerock Customer Service (see back cover for contact information).

# PRODUCT INDEX

Product No.	Type	Finish	Product Detail in (mm)	Length in (mm)	Width in (mm)	Projection in (mm)	Base Dimensions in (mm)	Base Material	Mounting Hardware Included	ADA-Friendly
<b>Calathea (continued) • p. 62</b>										
BP100316026	Pull	Polished Chrome	6-5/16 (160) CTC	7 (178)	1-1/16 (27)	1-1/16 (27)	1/2 L x 1-1/16 W (13 L x 27 W)	Zinc	(2) M4 X 1in Truss Head Machine Screw (2) M4 X 1-9/16in Truss Head Machine Screw	N/A
BP1003160BCR	Pull	Black Chrome	6-5/16 (160) CTC	7 (178)	1-1/16 (27)	1-1/16 (27)	1/2 L x 1-1/16 W (13 L x 27 W)	Zinc	(2) M4 X 1in Truss Head Machine Screw (2) M4 X 1-9/16in Truss Head Machine Screw	N/A
BP1003160BGL	Pull	Brushed Gold	6-5/16 (160) CTC	7 (178)	1-1/16 (27)	1-1/16 (27)	1/2 L x 1-1/16 W (13 L x 27 W)	Zinc	(2) M4 X 1in Truss Head Machine Screw (2) M4 X 1-9/16in Truss Head Machine Screw	N/A
BP1003160G10	Pull	Satin Nickel	6-5/16 (160) CTC	7 (178)	1-1/16 (27)	1-1/16 (27)	1/2 L x 1-1/16 W (13 L x 27 W)	Zinc	(2) M4 X 1in Truss Head Machine Screw (2) M4 X 1-9/16in Truss Head Machine Screw	N/A
BP1003160MB	Pull	Matte Black	6-5/16 (160) CTC	7 (178)	1-1/16 (27)	1-1/16 (27)	1/2 L x 1-1/16 W (13 L x 27 W)	Zinc	(2) M4 X 1in Truss Head Machine Screw (2) M4 X 1-9/16in Truss Head Machine Screw	N/A
BP10039626	Pull	Polished Chrome	3-3/4 (96) CTC	4-7/16 (113)	1-1/16 (27)	1-1/16 (27)	1/2 L x 1-1/16 W (13 L x 27 W)	Zinc	(2) M4 X 1in Truss Head Machine Screw (2) M4 X 1-9/16in Truss Head Machine Screw	N/A
BP100396BCR	Pull	Black Chrome	3-3/4 (96) CTC	4-7/16 (113)	1-1/16 (27)	1-1/16 (27)	1/2 L x 1-1/16 W (13 L x 27 W)	Zinc	(2) M4 X 1in Truss Head Machine Screw (2) M4 X 1-9/16in Truss Head Machine Screw	N/A
BP100396BGL	Pull	Brushed Gold	3-3/4 (96) CTC	4-7/16 (113)	1-1/16 (27)	1-1/16 (27)	1/2 L x 1-1/16 W (13 L x 27 W)	Zinc	(2) M4 X 1in Truss Head Machine Screw (2) M4 X 1-9/16in Truss Head Machine Screw	N/A
BP100396G10	Pull	Satin Nickel	3-3/4 (96) CTC	4-7/16 (113)	1-1/16 (27)	1-1/16 (27)	1/2 L x 1-1/16 W (13 L x 27 W)	Zinc	(2) M4 X 1in Truss Head Machine Screw (2) M4 X 1-9/16in Truss Head Machine Screw	N/A
BP100396MB	Pull	Matte Black	3-3/4 (96) CTC	4-7/16 (113)	1-1/16 (27)	1-1/16 (27)	1/2 L x 1-1/16 W (13 L x 27 W)	Zinc	(2) M4 X 1in Truss Head Machine Screw (2) M4 X 1-9/16in Truss Head Machine Screw	N/A
BP1013226	Pull	Polished Chrome	1-1/4 (32) CTC	1-15/16 (49)	1-15/16 (49)	1-1/8 (29)	1-9/16 L x 5/16 W (40 L x 33 W)	Zinc	(2) M4 X 1in Truss Head Machine Screw (2) M4 X 1-9/16in Truss Head Machine Screw	N/A
BP10132BCR	Pull	Black Chrome	1-1/4 (32) CTC	1-15/16 (49)	1-15/16 (49)	1-1/8 (29)	1-9/16 L x 5/16 W (40 L x 33 W)	Zinc	(2) M4 X 1in Truss Head Machine Screw (2) M4 X 1-9/16in Truss Head Machine Screw	N/A
BP10132BGL	Pull	Brushed Gold	1-1/4 (32) CTC	1-15/16 (49)	1-15/16 (49)	1-1/8 (29)	1-9/16 L x 5/16 W (40 L x 33 W)	Zinc	(2) M4 X 1in Truss Head Machine Screw (2) M4 X 1-9/16in Truss Head Machine Screw	N/A
BP10132G10	Pull	Satin Nickel	1-1/4 (32) CTC	1-15/16 (49)	1-15/16 (49)	1-1/8 (29)	1-9/16 L x 5/16 W (40 L x 33 W)	Zinc	(2) M4 X 1in Truss Head Machine Screw (2) M4 X 1-9/16in Truss Head Machine Screw	N/A
BP10132MB	Pull	Matte Black	1-1/4 (32) CTC	1-15/16 (49)	1-15/16 (49)	1-1/8 (29)	1-9/16 L x 5/16 W (40 L x 33 W)	Zinc	(2) M4 X 1in Truss Head Machine Screw (2) M4 X 1-9/16in Truss Head Machine Screw	N/A
<b>Kamari • p. 64</b>										
BP36820BBZ	Knob	Golden Champagne	1-3/16 (30) DIA	1-3/16 (30)	N/As	1 (25)	3/8 L x 3/8 W (10 L x 10 W)	Zinc	(1) #8-32 x 1in Truss Head Machine Screw (1) #8-32 x 1-1/2in Truss Head Machine Screw	N/A
BP36820G10	Knob	Satin Nickel	1-3/16 (30) DIA	1-3/16 (30)	N/A	1 (25)	3/8 L x 3/8 W (10 L x 10 W)	Zinc	(1) #8-32 x 1in Truss Head Machine Screw (1) #8-32 x 1-1/2in Truss Head Machine Screw	N/A
BP36820GM	Knob	Gunmetal	1-3/16 (30) DIA	1-3/16 (30)	N/A	1 (25)	3/8 L x 3/8 W (10 L x 10 W)	Zinc	(1) #8-32 x 1in Truss Head Machine Screw (1) #8-32 x 1-1/2in Truss Head Machine Screw	N/A
BP36820MB	Knob	Matte Black	1-3/16 (30) DIA	1-3/16 (30)	N/A	1 (25)	3/8 L x 3/8 W (10 L x 10 W)	Zinc	(1) #8-32 x 1in Truss Head Machine Screw (1) #8-32 x 1-1/2in Truss Head Machine Screw	N/A
BP36820PN	Knob	Polished Nickel	1-3/16 (30) DIA	1-3/16 (30)	N/A	1 (25)	3/8 L x 3/8 W (10 L x 10 W)	Zinc	(1) #8-32 x 1in Truss Head Machine Screw (1) #8-32 x 1-1/2in Truss Head Machine Screw	N/A
BP36821BBZ	Knob	Golden Champagne	1-3/16 (30) LGTH	1-3/16 (30)	1-3/16 (30)	1 (25)	3/8 L x 3/8 W (10 L x 10 W)	Zinc	(1) #8-32 x 1in Truss Head Machine Screw (1) #8-32 x 1-1/2in Truss Head Machine Screw	N/A
BP36821G10	Knob	Satin Nickel	1-3/16 (30) LGTH	1-3/16 (30)	1-3/16 (30)	1 (25)	3/8 L x 3/8 W (10 L x 10 W)	Zinc	(1) #8-32 x 1in Truss Head Machine Screw (1) #8-32 x 1-1/2in Truss Head Machine Screw	N/A
BP36821GM	Knob	Gunmetal	1-3/16 (30) LGTH	1-3/16 (30)	1-3/16 (30)	1 (25)	3/8 L x 3/8 W (10 L x 10 W)	Zinc	(1) #8-32 x 1in Truss Head Machine Screw (1) #8-32 x 1-1/2in Truss Head Machine Screw	N/A

Mounting hardware included.  
The dimensional information provided here should be verified with the actual product prior to drilling or attempting to install the hardware.  
Please direct any questions you may have on the installation process to Amerock Customer Service (see back cover for contact information).

# PRODUCT INDEX

Product No.	Type	Finish	Product Detail in (mm)	Length in (mm)	Width in (mm)	Projection in (mm)	Base Dimensions in (mm)	Base Material	Mounting Hardware Included	ADA-Friendly
<b>Kamari (continued) • p. 64</b>										
BP36821MB	Knob	Matte Black	1-3/16 (30) LGTH	1-3/16 (30)	1-3/16 (30)	1 (25)	3/8 L x 3/8 W (10 L x 10 W)	Zinc	(1) #8-32 x 1in Truss Head Machine Screw (1) #8-32 x 1-1/2in Truss Head Machine Screw	N/A
BP36821PN	Knob	Polished Nickel	1-3/16 (30) LGTH	1-3/16 (30)	1-3/16 (30)	1 (25)	3/8 L x 3/8 W (10 L x 10 W)	Zinc	(1) #8-32 x 1in Truss Head Machine Screw (1) #8-32 x 1-1/2in Truss Head Machine Screw	N/A
BP36822BBZ	Pull	Golden Champagne	3-3/4 (96) CTC	4-15/16 (125)	1-3/16 (30)	1 (25)	3/8 L x 3/8 W (10 L x 10 W)	Zinc	(2) #8-32 x 1in Truss Head Machine Screw (2) #8-32 x 1-1/2in Truss Head Machine Screw	N/A
BP36822G10	Pull	Satin Nickel	3-3/4 (96) CTC	4-15/16 (125)	1-3/16 (30)	1 (25)	3/8 L x 3/8 W (10 L x 10 W)	Zinc	(2) #8-32 x 1in Truss Head Machine Screw (2) #8-32 x 1-1/2in Truss Head Machine Screw	N/A
BP36822GM	Pull	Gunmetal	3-3/4 (96) CTC	4-15/16 (125)	1-3/16 (30)	1 (25)	3/8 L x 3/8 W (10 L x 10 W)	Zinc	(2) #8-32 x 1in Truss Head Machine Screw (2) #8-32 x 1-1/2in Truss Head Machine Screw	N/A
BP36822MB	Pull	Matte Black	3-3/4 (96) CTC	4-15/16 (125)	1-3/16 (30)	1 (25)	3/8 L x 3/8 W (10 L x 10 W)	Zinc	(2) #8-32 x 1in Truss Head Machine Screw (2) #8-32 x 1-1/2in Truss Head Machine Screw	N/A
BP36822PN	Pull	Polished Nickel	3-3/4 (96) CTC	4-15/16 (125)	1-3/16 (30)	1 (25)	3/8 L x 3/8 W (10 L x 10 W)	Zinc	(2) #8-32 x 1in Truss Head Machine Screw (2) #8-32 x 1-1/2in Truss Head Machine Screw	N/A
BP36823BBZ	Pull	Golden Champagne	5-1/16 (128) CTC	6-3/16 (157)	1-3/16 (30)	1 (25)	3/8 L x 3/8 W (10 L x 10 W)	Zinc	(2) #8-32 x 1in Truss Head Machine Screw (2) #8-32 x 1-1/2in Truss Head Machine Screw	N/A
BP36823G10	Pull	Satin Nickel	5-1/16 (128) CTC	6-3/16 (157)	1-3/16 (30)	1 (25)	3/8 L x 3/8 W (10 L x 10 W)	Zinc	(2) #8-32 x 1in Truss Head Machine Screw (2) #8-32 x 1-1/2in Truss Head Machine Screw	N/A
BP36823GM	Pull	Gunmetal	5-1/16 (128) CTC	6-3/16 (157)	1-3/16 (30)	1 (25)	3/8 L x 3/8 W (10 L x 10 W)	Zinc	(2) #8-32 x 1in Truss Head Machine Screw (2) #8-32 x 1-1/2in Truss Head Machine Screw	N/A
BP36823MB	Pull	Matte Black	5-1/16 (128) CTC	6-3/16 (157)	1-3/16 (30)	1 (25)	3/8 L x 3/8 W (10 L x 10 W)	Zinc	(2) #8-32 x 1in Truss Head Machine Screw (2) #8-32 x 1-1/2in Truss Head Machine Screw	N/A
BP36823PN	Pull	Polished Nickel	5-1/16 (128) CTC	6-3/16 (157)	1-3/16 (30)	1 (25)	3/8 L x 3/8 W (10 L x 10 W)	Zinc	(2) #8-32 x 1in Truss Head Machine Screw (2) #8-32 x 1-1/2in Truss Head Machine Screw	N/A
BP36824BBZ	Pull	Golden Champagne	6-5/16 (160) CTC	7-7/16 (189)	1-3/16 (30)	1 (25)	3/8 L x 3/8 W (10 L x 10 W)	Zinc	(2) #8-32 x 1in Truss Head Machine Screw (2) #8-32 x 1-1/2in Truss Head Machine Screw	N/A
BP36824G10	Pull	Satin Nickel	6-5/16 (160) CTC	7-7/16 (189)	1-3/16 (30)	1 (25)	3/8 L x 3/8 W (10 L x 10 W)	Zinc	(2) #8-32 x 1in Truss Head Machine Screw (2) #8-32 x 1-1/2in Truss Head Machine Screw	N/A
BP36824GM	Pull	Gunmetal	6-5/16 (160) CTC	7-7/16 (189)	1-3/16 (30)	1 (25)	3/8 L x 3/8 W (10 L x 10 W)	Zinc	(2) #8-32 x 1in Truss Head Machine Screw (2) #8-32 x 1-1/2in Truss Head Machine Screw	N/A
BP36824MB	Pull	Matte Black	6-5/16 (160) CTC	7-7/16 (189)	1-3/16 (30)	1 (25)	3/8 L x 3/8 W (10 L x 10 W)	Zinc	(2) #8-32 x 1in Truss Head Machine Screw (2) #8-32 x 1-1/2in Truss Head Machine Screw	N/A
BP36824PN	Pull	Polished Nickel	6-5/16 (160) CTC	7-7/16 (189)	1-3/16 (30)	1 (25)	3/8 L x 3/8 W (10 L x 10 W)	Zinc	(2) #8-32 x 1in Truss Head Machine Screw (2) #8-32 x 1-1/2in Truss Head Machine Screw	N/A
BP36825BBZ	Pull	Golden Champagne	7-9/16 (192) CTC	8-3/4 (222)	1-3/16 (30)	1 (25)	3/8 L x 3/8 W (10 L x 10 W)	Zinc	(2) #8-32 x 1in Truss Head Machine Screw (2) #8-32 x 1-1/2in Truss Head Machine Screw	N/A
BP36825G10	Pull	Satin Nickel	7-9/16 (192) CTC	8-3/4 (222)	1-3/16 (30)	1 (25)	3/8 L x 3/8 W (10 L x 10 W)	Zinc	(2) #8-32 x 1in Truss Head Machine Screw (2) #8-32 x 1-1/2in Truss Head Machine Screw	N/A
BP36825GM	Pull	Gunmetal	7-9/16 (192) CTC	8-3/4 (222)	1-3/16 (30)	1 (25)	3/8 L x 3/8 W (10 L x 10 W)	Zinc	(2) #8-32 x 1in Truss Head Machine Screw (2) #8-32 x 1-1/2in Truss Head Machine Screw	N/A
BP36825MB	Pull	Matte Black	7-9/16 (192) CTC	8-3/4 (222)	1-3/16 (30)	1 (25)	3/8 L x 3/8 W (10 L x 10 W)	Zinc	(2) #8-32 x 1in Truss Head Machine Screw (2) #8-32 x 1-1/2in Truss Head Machine Screw	N/A
BP36825PN	Pull	Polished Nickel	7-9/16 (192) CTC	8-3/4 (222)	1-3/16 (30)	1 (25)	3/8 L x 3/8 W (10 L x 10 W)	Zinc	(2) #8-32 x 1in Truss Head Machine Screw (2) #8-32 x 1-1/2in Truss Head Machine Screw	N/A
BP36826BBZ	Pull	Golden Champagne	10-1/16 (256) CTC	11-1/4 (286)	1-3/16 (30)	1 (25)	3/8 L x 3/8 W (10 L x 10 W)	Zinc	(2) #8-32 x 1in Truss Head Machine Screw (2) #8-32 x 1-1/2in Truss Head Machine Screw	N/A
BP36826G10	Pull	Satin Nickel	10-1/16 (256) CTC	11-1/4 (286)	1-3/16 (30)	1 (25)	3/8 L x 3/8 W (10 L x 10 W)	Zinc	(2) #8-32 x 1in Truss Head Machine Screw (2) #8-32 x 1-1/2in Truss Head Machine Screw	N/A
BP36826GM	Pull	Gunmetal	10-1/16 (256) CTC	11-1/4 (286)	1-3/16 (30)	1 (25)	3/8 L x 3/8 W (10 L x 10 W)	Zinc	(2) #8-32 x 1in Truss Head Machine Screw (2) #8-32 x 1-1/2in Truss Head Machine Screw	N/A

Mounting hardware included.  
The dimensional information provided here should be verified with the actual product prior to drilling or attempting to install the hardware.  
Please direct any questions you may have on the installation process to Amerock Customer Service (see back cover for contact information).



# PRODUCT INDEX

Product No.	Type	Finish	Product Detail in (mm)	Length in (mm)	Width in (mm)	Projection in (mm)	Base Dimensions in (mm)	Base Material	Mounting Hardware Included	ADA-Friendly
<b>Kamari (continued) • p. 64</b>										
BP36826MB	Pull	Matte Black	10-1/16 (256) CTC	11-1/4 (286)	1-3/16 (30)	1 (25)	3/8 L x 3/8 W (10 L x 10 W)	Zinc	(2) #8-32 x 1in Truss Head Machine Screw (2) #8-32 x 1-1/2in Truss Head Machine Screw	N/A
BP36826PN	Pull	Polished Nickel	10-1/16 (256) CTC	11-1/4 (286)	1-3/16 (30)	1 (25)	3/8 L x 3/8 W (10 L x 10 W)	Zinc	(2) #8-32 x 1in Truss Head Machine Screw (2) #8-32 x 1-1/2in Truss Head Machine Screw	N/A
<b>Urbanite • p. 66</b>										
BP6726BCR	Knob	Polished Chrome/ Black Chrome	2-5/8 (67) LGTH	2-5/8 (67)	1/2 (13)	1-3/16 (30)	7/16 L x 1/2 W (11 L x 13 W)	Zinc/ Aluminum	(1) M4 X 1 in Truss Head Machine Screw (1) M4 X 1-9/16 in Truss Head Machine Screw	N/A
BP6726BMB	Knob	Polished Chrome/ Brushed Matte Black	2-5/8 (67) LGTH	2-5/8 (67)	1/2 (13)	1-3/16 (30)	7/16 L x 1/2 W (11 L x 13 W)	Zinc/ Aluminum	(1) M4 X 1 in Truss Head Machine Screw (1) M4 X 1-9/16 in Truss Head Machine Screw	N/A
BP6726G10	Knob	Polished Chrome/ Satin Nickel	2-5/8 (67) LGTH	2-5/8 (67)	1/2 (13)	1-3/16 (30)	7/16 L x 1/2 W (11 L x 13 W)	Zinc/ Aluminum	(1) M4 X 1 in Truss Head Machine Screw (1) M4 X 1-9/16 in Truss Head Machine Screw	N/A
BP6726WHT	Knob	Polished Chrome/ White	2-5/8 (67) LGTH	2-5/8 (67)	1/2 (13)	1-3/16 (30)	7/16 L x 1/2 W (11 L x 13 W)	Zinc/ Aluminum	(1) M4 X 1 in Truss Head Machine Screw (1) M4 X 1-9/16 in Truss Head Machine Screw	N/A
BP67BGLBCR	Knob	Brushed Gold/ Black Chrome	2-5/8 (67) LGTH	2-5/8 (67)	1/2 (13)	1-3/16 (30)	7/16 L x 1/2 W (11 L x 13 W)	Zinc/ Aluminum	(1) M4 X 1 in Truss Head Machine Screw (1) M4 X 1-9/16 in Truss Head Machine Screw	N/A
BP67BGLMB	Knob	Brushed Gold/ Matte Black	2-5/8 (67) LGTH	2-5/8 (67)	1/2 (13)	1-3/16 (30)	7/16 L x 1/2 W (11 L x 13 W)	Zinc/ Aluminum	(1) M4 X 1 in Truss Head Machine Screw (1) M4 X 1-9/16 in Truss Head Machine Screw	N/A
BP67BGLWHT	Knob	Brushed Gold/White	2-5/8 (67) LGTH	2-5/8 (67)	1/2 (13)	1-3/16 (30)	7/16 L x 1/2 W (11 L x 13 W)	Zinc/ Aluminum	(1) M4 X 1 in Truss Head Machine Screw (1) M4 X 1-9/16 in Truss Head Machine Screw	N/A
BP67MBMB	Knob	Matte Black/ Matte Black	2-5/8 (67) LGTH	2-5/8 (67)	1/2 (13)	1-3/16 (30)	7/16 L x 1/2 W (11 L x 13 W)	Zinc/ Aluminum	(1) M4 X 1 in Truss Head Machine Screw (1) M4 X 1-9/16 in Truss Head Machine Screw	N/A
BP77812826BCR	Pull	Polished Chrome/ Black Chrome	5-1/16 (128) CTC	7-13/16 (198)	1/2 (13)	1-3/16 (30)	7/16 L x 1/2 W (11 L x 13 W)	Zinc/ Aluminum	(2) M4 X 1in Truss Head Machine Screw (2) M4 X 1-9/16in Truss Head Machine Screw	N/A
BP77812826BMB	Pull	Polished Chrome/ Brushed Matte Black	5-1/16 (128) CTC	7-13/16 (198)	1/2 (13)	1-3/16 (30)	7/16 L x 1/2 W (11 L x 13 W)	Zinc/ Aluminum	(2) M4 X 1in Truss Head Machine Screw (2) M4 X 1-9/16in Truss Head Machine Screw	N/A
BP77812826G10	Pull	Polished Chrome/ Satin Nickel	5-1/16 (128) CTC	7-13/16 (198)	1/2 (13)	1-3/16 (30)	7/16 L x 1/2 W (11 L x 13 W)	Zinc/ Aluminum	(2) M4 X 1in Truss Head Machine Screw (2) M4 X 1-9/16in Truss Head Machine Screw	N/A
BP77812826WHT	Pull	Polished Chrome/ White	5-1/16 (128) CTC	7-13/16 (198)	1/2 (13)	1-3/16 (30)	7/16 L x 1/2 W (11 L x 13 W)	Zinc/ Aluminum	(2) M4 X 1in Truss Head Machine Screw (2) M4 X 1-9/16in Truss Head Machine Screw	N/A
BP778128BGLBCR	Pull	Brushed Gold/ Black Chrome	5-1/16 (128) CTC	7-13/16 (198)	1/2 (13)	1-3/16 (30)	7/16 L x 1/2 W (11 L x 13 W)	Zinc/ Aluminum	(2) M4 X 1in Truss Head Machine Screw (2) M4 X 1-9/16in Truss Head Machine Screw	N/A
BP778128BGLMB	Pull	Brushed Gold/ Matte Black	5-1/16 (128) CTC	7-13/16 (198)	1/2 (13)	1-3/16 (30)	7/16 L x 1/2 W (11 L x 13 W)	Zinc/ Aluminum	(2) M4 X 1in Truss Head Machine Screw (2) M4 X 1-9/16in Truss Head Machine Screw	N/A
BP778128BGLWHT	Pull	Brushed Gold/White	5-1/16 (128) CTC	7-13/16 (198)	1/2 (13)	1-3/16 (30)	7/16 L x 1/2 W (11 L x 13 W)	Zinc/ Aluminum	(2) M4 X 1in Truss Head Machine Screw (2) M4 X 1-9/16in Truss Head Machine Screw	N/A
BP778128MBMB	Pull	Matte Black/ Matte Black	5-1/16 (128) CTC	7-13/16 (198)	1/2 (13)	1-3/16 (30)	7/16 L x 1/2 W (11 L x 13 W)	Zinc/ Aluminum	(2) M4 X 1in Truss Head Machine Screw (2) M4 X 1-9/16in Truss Head Machine Screw	N/A
BP77816026BCR	Pull	Polished Chrome/ Black Chrome	6-5/16 (160) CTC	9-1/16 (230)	1/2 (13)	1-3/16 (30)	7/16 L x 1/2 W (11 L x 13 W)	Zinc/ Aluminum	(2) M4 X 1in Truss Head Machine Screw (2) M4 X 1-9/16in Truss Head Machine Screw	N/A
BP77816026BMB	Pull	Polished Chrome/ Brushed Matte Black	6-5/16 (160) CTC	9-1/16 (230)	1/2 (13)	1-3/16 (30)	7/16 L x 1/2 W (11 L x 13 W)	Zinc/ Aluminum	(2) M4 X 1in Truss Head Machine Screw (2) M4 X 1-9/16in Truss Head Machine Screw	N/A
BP77816026G10	Pull	Polished Chrome/ Satin Nickel	6-5/16 (160) CTC	9-1/16 (230)	1/2 (13)	1-3/16 (30)	7/16 L x 1/2 W (11 L x 13 W)	Zinc/ Aluminum	(2) M4 X 1in Truss Head Machine Screw (2) M4 X 1-9/16in Truss Head Machine Screw	N/A
BP77816026WHT	Pull	Polished Chrome/ White	6-5/16 (160) CTC	9-1/16 (230)	1/2 (13)	1-3/16 (30)	7/16 L x 1/2 W (11 L x 13 W)	Zinc/ Aluminum	(2) M4 X 1in Truss Head Machine Screw (2) M4 X 1-9/16in Truss Head Machine Screw	N/A
BP778160BGLBCR	Pull	Brushed Gold/ Black Chrome	6-5/16 (160) CTC	9-1/16 (230)	1/2 (13)	1-3/16 (30)	7/16 L x 1/2 W (11 L x 13 W)	Zinc/ Aluminum	(2) M4 X 1in Truss Head Machine Screw (2) M4 X 1-9/16in Truss Head Machine Screw	N/A

Mounting hardware included.  
The dimensional information provided here should be verified with the actual product prior to drilling or attempting to install the hardware.  
Please direct any questions you may have on the installation process to Amerock Customer Service (see back cover for contact information).

# PRODUCT INDEX

Product No.	Type	Finish	Product Detail in (mm)	Length in (mm)	Width in (mm)	Projection in (mm)	Base Dimensions in (mm)	Base Material	Mounting Hardware Included	ADA-Friendly
<b>Urbanite (continued) • p. 66</b>										
BP778160BGLMB	Pull	Brushed Gold/ Matte Black	6-5/16 (160) CTC	9-1/16 (230)	1/2 (13)	1-3/16 (30)	7/16 L x 1/2 W (11 L x 13 W)	Zinc/ Aluminum	(2) M4 X 1in Truss Head Machine Screw (2) M4 X 1-9/16in Truss Head Machine Screw	N/A
BP778160BGLWHT	Pull	Brushed Gold/White	6-5/16 (160) CTC	9-1/16 (230)	1/2 (13)	1-3/16 (30)	7/16 L x 1/2 W (11 L x 13 W)	Zinc/ Aluminum	(2) M4 X 1in Truss Head Machine Screw & (2) M4 X 1-9/16in Truss Head Machine Screw	N/A
BP778160MBMB	Pull	Matte Black/ Matte Black	6-5/16 (160) CTC	9-1/16 (230)	1/2 (13)	1-3/16 (30)	7/16 L x 1/2 W (11 L x 13 W)	Zinc/ Aluminum	(2) M4 X 1in Truss Head Machine Screw (2) M4 X 1-9/16in Truss Head Machine Screw	N/A
BP77819226BCR	Pull	Polished Chrome/ Black Chrome	7-9/16 (192) CTC	10-1/4 (260)	1/2 (13)	1-3/16 (30)	7/16 L x 1/2 W (11 L x 13 W)	Zinc/ Aluminum	(2) M4 X 1in Truss Head Machine Screw (2) M4 X 1-9/16in Truss Head Machine Screw	N/A
BP77819226BMB	Pull	Polished Chrome/ Brushed Matte Black	7-9/16 (192) CTC	10-1/4 (260)	1/2 (13)	1-3/16 (30)	7/16 L x 1/2 W (11 L x 13 W)	Zinc/ Aluminum	(2) M4 X 1in Truss Head Machine Screw (2) M4 X 1-9/16in Truss Head Machine Screw	N/A
BP77819226G10	Pull	Polished Chrome/ Satin Nickel	7-9/16 (192) CTC	10-1/4 (260)	1/2 (13)	1-3/16 (30)	7/16 L x 1/2 W (11 L x 13 W)	Zinc/ Aluminum	(2) M4 X 1in Truss Head Machine Screw (2) M4 X 1-9/16in Truss Head Machine Screw	N/A
BP77819226WHT	Pull	Polished Chrome/ White	7-9/16 (192) CTC	10-1/4 (260)	1/2 (13)	1-3/16 (30)	7/16 L x 1/2 W (11 L x 13 W)	Zinc/ Aluminum	(2) M4 X 1in Truss Head Machine Screw (2) M4 X 1-9/16in Truss Head Machine Screw	N/A
BP778192BGLBCR	Pull	Brushed Gold/ Black Chrome	7-9/16 (192) CTC	10-1/4 (260)	1/2 (13)	1-3/16 (30)	7/16 L x 1/2 W (11 L x 13 W)	Zinc/ Aluminum	(2) M4 X 1in Truss Head Machine Screw (2) M4 X 1-9/16in Truss Head Machine Screw	N/A
BP778192BGLMB	Pull	Brushed Gold/ Matte Black	7-9/16 (192) CTC	10-1/4 (260)	1/2 (13)	1-3/16 (30)	7/16 L x 1/2 W (11 L x 13 W)	Zinc/ Aluminum	(2) M4 X 1in Truss Head Machine Screw (2) M4 X 1-9/16in Truss Head Machine Screw	N/A
BP778192BGLWHT	Pull	Brushed Gold/White	7-9/16 (192) CTC	10-1/4 (260)	1/2 (13)	1-3/16 (30)	7/16 L x 1/2 W (11 L x 13 W)	Zinc/ Aluminum	(2) M4 X 1in Truss Head Machine Screw (2) M4 X 1-9/16in Truss Head Machine Screw	N/A
BP778192MBMB	Pull	Matte Black/ Matte Black	7-9/16 (192) CTC	10-1/4 (260)	1/2 (13)	1-3/16 (30)	7/16 L x 1/2 W (11 L x 13 W)	Zinc/ Aluminum	(2) M4 X 1in Truss Head Machine Screw (2) M4 X 1-9/16in Truss Head Machine Screw	N/A
BP77825626BCR	Pull	Polished Chrome/ Black Chrome	10-1/16 (256) CTC	12-3/4 (324)	1/2 (13)	1-3/16 (30)	7/16 L x 1/2 W (11 L x 13 W)	Zinc/ Aluminum	(2) M4 X 1in Truss Head Machine Screw (2) M4 X 1-9/16in Truss Head Machine Screw	N/A
BP77825626BMB	Pull	Polished Chrome/ Brushed Matte Black	10-1/16 (256) CTC	12-3/4 (324)	1/2 (13)	1-3/16 (30)	7/16 L x 1/2 W (11 L x 13 W)	Zinc/ Aluminum	(2) M4 X 1in Truss Head Machine Screw (2) M4 X 1-9/16in Truss Head Machine Screw	N/A
BP77825626G10	Pull	Polished Chrome/ Satin Nickel	10-1/16 (256) CTC	12-3/4 (324)	1/2 (13)	1-3/16 (30)	7/16 L x 1/2 W (11 L x 13 W)	Zinc/ Aluminum	(2) M4 X 1in Truss Head Machine Screw (2) M4 X 1-9/16in Truss Head Machine Screw	N/A
BP77825626WHT	Pull	Polished Chrome/ White	10-1/16 (256) CTC	12-3/4 (324)	1/2 (13)	1-3/16 (30)	7/16 L x 1/2 W (11 L x 13 W)	Zinc/ Aluminum	(2) M4 X 1in Truss Head Machine Screw (2) M4 X 1-9/16in Truss Head Machine Screw	N/A
BP778256BGLBCR	Pull	Brushed Gold/ Black Chrome	10-1/16 (256) CTC	12-3/4 (324)	1/2 (13)	1-3/16 (30)	7/16 L x 1/2 W (11 L x 13 W)	Zinc/ Aluminum	(2) M4 X 1in Truss Head Machine Screw (2) M4 X 1-9/16in Truss Head Machine Screw	N/A
BP778256BGLMB	Pull	Brushed Gold/ Matte Black	10-1/16 (256) CTC	12-3/4 (324)	1/2 (13)	1-3/16 (30)	7/16 L x 1/2 W (11 L x 13 W)	Zinc/ Aluminum	(2) M4 X 1in Truss Head Machine Screw (2) M4 X 1-9/16in Truss Head Machine Screw	N/A
BP778256BGLWHT	Pull	Brushed Gold/White	10-1/16 (256) CTC	12-3/4 (324)	1/2 (13)	1-3/16 (30)	7/16 L x 1/2 W (11 L x 13 W)	Zinc/ Aluminum	(2) M4 X 1in Truss Head Machine Screw (2) M4 X 1-9/16in Truss Head Machine Screw	N/A
BP778256MBMB	Pull	Matte Black/ Matte Black	10-1/16 (256) CTC	12-3/4 (324)	1/2 (13)	1-3/16 (30)	7/16 L x 1/2 W (11 L x 13 W)	Zinc/ Aluminum	(2) M4 X 1in Truss Head Machine Screw (2) M4 X 1-9/16in Truss Head Machine Screw	N/A
BP7789626BCR	Pull	Polished Chrome/ Black Chrome	3-3/4 (96) CTC	6-1/2 (165)	1/2 (13)	1-3/16 (30)	7/16 L x 1/2 W (11 L x 13 W)	Zinc/ Aluminum	(2) M4 X 1in Truss Head Machine Screw (2) M4 X 1-9/16in Truss Head Machine Screw	N/A
BP7789626BMB	Pull	Polished Chrome/ Brushed Matte Black	3-3/4 (96) CTC	6-1/2 (165)	1/2 (13)	1-3/16 (30)	7/16 L x 1/2 W (11 L x 13 W)	Zinc/ Aluminum	(2) M4 X 1in Truss Head Machine Screw (2) M4 X 1-9/16in Truss Head Machine Screw	N/A
BP7789626G10	Pull	Polished Chrome/ Satin Nickel	3-3/4 (96) CTC	6-1/2 (165)	1/2 (13)	1-3/16 (30)	7/16 L x 1/2 W (11 L x 13 W)	Zinc/ Aluminum	(2) M4 X 1in Truss Head Machine Screw (2) M4 X 1-9/16in Truss Head Machine Screw	N/A
BP7789626WHT	Pull	Polished Chrome/ White	3-3/4 (96) CTC	6-1/2 (165)	1/2 (13)	1-3/16 (30)	7/16 L x 1/2 W (11 L x 13 W)	Zinc/ Aluminum	(2) M4 X 1in Truss Head Machine Screw (2) M4 X 1-9/16in Truss Head Machine Screw	N/A
BP77896BGLBCR	Pull	Brushed Gold/ Black Chrome	3-3/4 (96) CTC	6-1/2 (165)	1/2 (13)	1-3/16 (30)	7/16 L x 1/2 W (11 L x 13 W)	Zinc/ Aluminum	(2) M4 X 1in Truss Head Machine Screw (2) M4 X 1-9/16in Truss Head Machine Screw	N/A
BP77896BGLMB	Pull	Brushed Gold/ Matte Black	3-3/4 (96) CTC	6-1/2 (165)	1/2 (13)	1-3/16 (30)	7/16 L x 1/2 W (11 L x 13 W)	Zinc/ Aluminum	(2) M4 X 1in Truss Head Machine Screw (2) M4 X 1-9/16in Truss Head Machine Screw	N/A

Mounting hardware included.  
The dimensional information provided here should be verified with the actual product prior to drilling or attempting to install the hardware.  
Please direct any questions you may have on the installation process to Amerock Customer Service (see back cover for contact information).

# PRODUCT INDEX

Product No.	Type	Finish	Product Detail in (mm)	Length in (mm)	Width in (mm)	Projection in (mm)	Base Dimensions in (mm)	Base Material	Mounting Hardware Included	ADA-Friendly
<b>Urbanite (continued) • p. 66</b>										
BP77896BGLWHT	Pull	Brushed Gold/White	3-3/4 (96) CTC	6-1/2 (165)	1/2 (13)	1-3/16 (30)	7/16 L x 1/2 W (11 L x 13 W)	Zinc/Aluminum	(2) M4 X 1in Truss Head Machine Screw (2) M4 X 1-9/16in Truss Head Machine Screw	N/A
BP77896MBMB	Pull	Matte Black/ Matte Black	3-3/4 (96) CTC	6-1/2 (165)	1/2 (13)	1-3/16 (30)	7/16 L x 1/2 W (11 L x 13 W)	Zinc/Aluminum	(2) M4 X 1in Truss Head Machine Screw (2) M4 X 1-9/16in Truss Head Machine Screw	N/A
<b>Transcendent • p. 68</b>										
BP196732MBMB	Knob	Matte Black	1-1/4 (32) DIA	1-1/4 (32)	N/A	7/8 (22)	1-1/4 L x 1-1/4 W (32 L x 32 W)	Aluminum	(1) M4 X 1 in Truss Head Machine Screw (1) M4 X 1-9/16 in Truss Head Machine Screw	N/A
BP196732MBMG	Knob	Matte Black/ Matte Gold	1-1/4 (32) DIA	1-1/4 (32)	N/A	7/8 (22)	1-1/4 L x 1-1/4 W (32 L x 32 W)	Aluminum	(1) M4 X 1 in Truss Head Machine Screw (1) M4 X 1-9/16 in Truss Head Machine Screw	N/A
BP196732MBPN	Knob	Matte Black/ Polished Nickel	1-1/4 (32) DIA	1-1/4 (32)	N/A	7/8 (22)	1-1/4 L x 1-1/4 W (32 L x 32 W)	Aluminum	(1) M4 X 1 in Truss Head Machine Screw (1) M4 X 1-9/16 in Truss Head Machine Screw	N/A
BP196732MBSC	Knob	Matte Black/ Silver Champagne	1-1/4 (32) DIA	1-1/4 (32)	N/A	7/8 (22)	1-1/4 L x 1-1/4 W (32 L x 32 W)	Aluminum	(1) M4 X 1 in Truss Head Machine Screw (1) M4 X 1-9/16 in Truss Head Machine Screw	N/A
BP196732MGMG	Knob	Matte Gold	1-1/4 (32) DIA	1-1/4 (32)	N/A	7/8 (22)	1-1/4 L x 1-1/4 W (32 L x 32 W)	Aluminum	(1) M4 X 1 in Truss Head Machine Screw (1) M4 X 1-9/16 in Truss Head Machine Screw	N/A
BP196732PNPN	Knob	Polished Nickel	1-1/4 (32) DIA	1-1/4 (32)	N/A	7/8 (22)	1-1/4 L x 1-1/4 W (32 L x 32 W)	Aluminum	(1) M4 X 1 in Truss Head Machine Screw (1) M4 X 1-9/16 in Truss Head Machine Screw	N/A
BP196732SCSC	Knob	Silver Champagne	1-1/4 (32) DIA	1-1/4 (32)	N/A	7/8 (22)	1-1/4 L x 1-1/4 W (32 L x 32 W)	Aluminum	(1) M4 X 1 in Truss Head Machine Screw (1) M4 X 1-9/16 in Truss Head Machine Screw	N/A
BP7414128MBMB	Pull	Matte Black	5-1/16 (128) CTC	8-3/16 (208)	3/8 (10)	1-3/16 (30)	1 L x 1 W (25 L x 25 W)	Aluminum	(2) M4 X 1in Truss Head Machine Screw (2) M4 X 1-9/16in Truss Head Machine Screw	N/A
BP7414128MBMG	Pull	Matte Black/ Matte Gold	5-1/16 (128) CTC	8-3/16 (208)	3/8 (10)	1-3/16 (30)	1 L x 1 W (25 L x 25 W)	Aluminum	(2) M4 X 1in Truss Head Machine Screw (2) M4 X 1-9/16in Truss Head Machine Screw	N/A
BP7414128MBPN	Pull	Matte Black/ Polished Nickel	5-1/16 (128) CTC	8-3/16 (208)	3/8 (10)	1-3/16 (30)	1 L x 1 W (25 L x 25 W)	Aluminum	(2) M4 X 1in Truss Head Machine Screw (2) M4 X 1-9/16in Truss Head Machine Screw	N/A
BP7414128MBSC	Pull	Matte Black/ Silver Champagne	5-1/16 (128) CTC	8-3/16 (208)	3/8 (10)	1-3/16 (30)	1 L x 1 W (25 L x 25 W)	Aluminum	(2) M4 X 1in Truss Head Machine Screw (2) M4 X 1-9/16in Truss Head Machine Screw	N/A
BP7414128MGMG	Pull	Matte Gold	5-1/16 (128) CTC	8-3/16 (208)	3/8 (10)	1-3/16 (30)	1 L x 1 W (25 L x 25 W)	Aluminum	(2) M4 X 1in Truss Head Machine Screw (2) M4 X 1-9/16in Truss Head Machine Screw	N/A
BP7414128PNPN	Pull	Polished Nickel	5-1/16 (128) CTC	8-3/16 (208)	3/8 (10)	1-3/16 (30)	1 L x 1 W (25 L x 25 W)	Aluminum	(2) M4 X 1in Truss Head Machine Screw (2) M4 X 1-9/16in Truss Head Machine Screw	N/A
BP7414128SCSC	Pull	Silver Champagne	5-1/16 (128) CTC	8-3/16 (208)	3/8 (10)	1-3/16 (30)	1 L x 1 W (25 L x 25 W)	Aluminum	(2) M4 X 1in Truss Head Machine Screw (2) M4 X 1-9/16in Truss Head Machine Screw	N/A
BP7414160MBMB	Pull	Matte Black	6-5/16 (160) CTC	9-7/16 (240)	3/8 (10)	1-3/16 (30)	1 L x 1 W (25 L x 25 W)	Aluminum	(2) M4 X 1in Truss Head Machine Screw (2) M4 X 1-9/16in Truss Head Machine Screw	N/A
BP7414160MBMG	Pull	Matte Black/ Matte Gold	6-5/16 (160) CTC	9-7/16 (240)	3/8 (10)	1-3/16 (30)	1 L x 1 W (25 L x 25 W)	Aluminum	(2) M4 X 1in Truss Head Machine Screw (2) M4 X 1-9/16in Truss Head Machine Screw	N/A
BP7414160MBPN	Pull	Matte Black/ Polished Nickel	6-5/16 (160) CTC	9-7/16 (240)	3/8 (10)	1-3/16 (30)	1 L x 1 W (25 L x 25 W)	Aluminum	(2) M4 X 1in Truss Head Machine Screw (2) M4 X 1-9/16in Truss Head Machine Screw	N/A
BP7414160MBSC	Pull	Matte Black/ Silver Champagne	6-5/16 (160) CTC	9-7/16 (240)	3/8 (10)	1-3/16 (30)	1 L x 1 W (25 L x 25 W)	Aluminum	(2) M4 X 1in Truss Head Machine Screw (2) M4 X 1-9/16in Truss Head Machine Screw	N/A
BP7414160MGMG	Pull	Matte Gold	6-5/16 (160) CTC	9-7/16 (240)	3/8 (10)	1-3/16 (30)	1 L x 1 W (25 L x 25 W)	Aluminum	(2) M4 X 1in Truss Head Machine Screw (2) M4 X 1-9/16in Truss Head Machine Screw	N/A
BP7414160PNPN	Pull	Polished Nickel	6-5/16 (160) CTC	9-7/16 (240)	3/8 (10)	1-3/16 (30)	1 L x 1 W (25 L x 25 W)	Aluminum	(2) M4 X 1in Truss Head Machine Screw (2) M4 X 1-9/16in Truss Head Machine Screw	N/A
BP7414160SCSC	Pull	Silver Champagne	6-5/16 (160) CTC	9-7/16 (240)	3/8 (10)	1-3/16 (30)	1 L x 1 W (25 L x 25 W)	Aluminum	(2) M4 X 1in Truss Head Machine Screw (2) M4 X 1-9/16in Truss Head Machine Screw	N/A
BP741416MBMB	Pull	Matte Black	5/8 (16) CTC	3-3/16 (81)	3/8 (10)	1-3/16 (30)	1 L x 1 W (25 L x 25 W)	Aluminum	(2) M4 X 1in Truss Head Machine Screw (2) M4 X 1-9/16in Truss Head Machine Screw	N/A

Mounting hardware included.  
The dimensional information provided here should be verified with the actual product prior to drilling or attempting to install the hardware.  
Please direct any questions you may have on the installation process to Amerock Customer Service (see back cover for contact information).

# PRODUCT INDEX

Product No.	Type	Finish	Product Detail in (mm)	Length in (mm)	Width in (mm)	Projection in (mm)	Base Dimensions in (mm)	Base Material	Mounting Hardware Included	ADA-Friendly
<b>Transcendent (continued) • p. 68</b>										
BP741416MBMG	Pull	Matte Black/ Matte Gold	5/8 (16) CTC	3-3/16 (81)	3/8 (10)	1-3/16 (30)	1 L x 1 W (25 L x 25 W)	Aluminum	(2) M4 X 1in Truss Head Machine Screw (2) M4 X 1-9/16in Truss Head Machine Screw	N/A
BP741416MBPN	Pull	Matte Black/ Polished Nickel	5/8 (16) CTC	3-3/16 (81)	3/8 (10)	1-3/16 (30)	1 L x 1 W (25 L x 25 W)	Aluminum	(2) M4 X 1in Truss Head Machine Screw (2) M4 X 1-9/16in Truss Head Machine Screw	N/A
BP741416MBSC	Pull	Matte Black/ Silver Champagne	5/8 (16) CTC	3-3/16 (81)	3/8 (10)	1-3/16 (30)	1 L x 1 W (25 L x 25 W)	Aluminum	(2) M4 X 1in Truss Head Machine Screw (2) M4 X 1-9/16in Truss Head Machine Screw	N/A
BP741416MGMG	Pull	Matte Gold	5/8 (16) CTC	3-3/16 (81)	3/8 (10)	1-3/16 (30)	1 L x 1 W (25 L x 25 W)	Aluminum	(2) M4 X 1in Truss Head Machine Screw (2) M4 X 1-9/16in Truss Head Machine Screw	N/A
BP741416PNPN	Pull	Polished Nickel	5/8 (16) CTC	3-3/16 (81)	3/8 (10)	1-3/16 (30)	1 L x 1 W (25 L x 25 W)	Aluminum	(2) M4 X 1in Truss Head Machine Screw (2) M4 X 1-9/16in Truss Head Machine Screw	N/A
BP741416SCSC	Pull	Silver Champagne	5/8 (16) CTC	3-3/16 (81)	3/8 (10)	1-3/16 (30)	1 L x 1 W (25 L x 25 W)	Aluminum	(2) M4 X 1in Truss Head Machine Screw (2) M4 X 1-9/16in Truss Head Machine Screw	N/A
BP7414192MBMB	Pull	Matte Black	7-9/16 (192) CTC	10-11/16 (271)	3/8 (10)	1-3/16 (30)	1 L x 1 W (25 L x 25 W)	Aluminum	(2) M4 X 1in Truss Head Machine Screw (2) M4 X 1-9/16in Truss Head Machine Screw	N/A
BP7414192MBMG	Pull	Matte Black/ Matte Gold	7-9/16 (192) CTC	10-11/16 (271)	3/8 (10)	1-3/16 (30)	1 L x 1 W (25 L x 25 W)	Aluminum	(2) M4 X 1in Truss Head Machine Screw (2) M4 X 1-9/16in Truss Head Machine Screw	N/A
BP7414192MBPN	Pull	Matte Black/ Polished Nickel	7-9/16 (192) CTC	10-11/16 (271)	3/8 (10)	1-3/16 (30)	1 L x 1 W (25 L x 25 W)	Aluminum	(2) M4 X 1in Truss Head Machine Screw (2) M4 X 1-9/16in Truss Head Machine Screw	N/A
BP7414192MBSC	Pull	Matte Black/ Silver Champagne	7-9/16 (192) CTC	10-11/16 (271)	3/8 (10)	1-3/16 (30)	1 L x 1 W (25 L x 25 W)	Aluminum	(2) M4 X 1in Truss Head Machine Screw (2) M4 X 1-9/16in Truss Head Machine Screw	N/A
BP7414192MGMG	Pull	Matte Gold	7-9/16 (192) CTC	10-11/16 (271)	3/8 (10)	1-3/16 (30)	1 L x 1 W (25 L x 25 W)	Aluminum	(2) M4 X 1in Truss Head Machine Screw (2) M4 X 1-9/16in Truss Head Machine Screw	N/A
BP7414192PNPN	Pull	Polished Nickel	7-9/16 (192) CTC	10-11/16 (271)	3/8 (10)	1-3/16 (30)	1 L x 1 W (25 L x 25 W)	Aluminum	(2) M4 X 1in Truss Head Machine Screw (2) M4 X 1-9/16in Truss Head Machine Screw	N/A
BP7414192SCSC	Pull	Silver Champagne	7-9/16 (192) CTC	10-11/16 (271)	3/8 (10)	1-3/16 (30)	1 L x 1 W (25 L x 25 W)	Aluminum	(2) M4 X 1in Truss Head Machine Screw (2) M4 X 1-9/16in Truss Head Machine Screw	N/A
BP7414256MBMB	Pull	Matte Black	10-1/16 (256) CTC	13-3/16 (335)	3/8 (10)	1-3/16 (30)	1 L x 1 W (25 L x 25 W)	Aluminum	(2) M4 X 1in Truss Head Machine Screw (2) M4 X 1-9/16in Truss Head Machine Screw	N/A
BP7414256MBMG	Pull	Matte Black/ Matte Gold	10-1/16 (256) CTC	13-3/16 (335)	3/8 (10)	1-3/16 (30)	1 L x 1 W (25 L x 25 W)	Aluminum	(2) M4 X 1in Truss Head Machine Screw (2) M4 X 1-9/16in Truss Head Machine Screw	N/A
BP7414256MBPN	Pull	Matte Black/ Polished Nickel	10-1/16 (256) CTC	13-3/16 (335)	3/8 (10)	1-3/16 (30)	1 L x 1 W (25 L x 25 W)	Aluminum	(2) M4 X 1in Truss Head Machine Screw (2) M4 X 1-9/16in Truss Head Machine Screw	N/A
BP7414256MBSC	Pull	Matte Black/ Silver Champagne	10-1/16 (256) CTC	13-3/16 (335)	3/8 (10)	1-3/16 (30)	1 L x 1 W (25 L x 25 W)	Aluminum	(2) M4 X 1in Truss Head Machine Screw (2) M4 X 1-9/16in Truss Head Machine Screw	N/A
BP7414256MGMG	Pull	Matte Gold	10-1/16 (256) CTC	13-3/16 (335)	3/8 (10)	1-3/16 (30)	1 L x 1 W (25 L x 25 W)	Aluminum	(2) M4 X 1in Truss Head Machine Screw (2) M4 X 1-9/16in Truss Head Machine Screw	N/A
BP7414256PNPN	Pull	Polished Nickel	10-1/16 (256) CTC	13-3/16 (335)	3/8 (10)	1-3/16 (30)	1 L x 1 W (25 L x 25 W)	Aluminum	(2) M4 X 1in Truss Head Machine Screw (2) M4 X 1-9/16in Truss Head Machine Screw	N/A
BP7414256SCSC	Pull	Silver Champagne	10-1/16 (256) CTC	13-3/16 (335)	3/8 (10)	1-3/16 (30)	1 L x 1 W (25 L x 25 W)	Aluminum	(2) M4 X 1in Truss Head Machine Screw (2) M4 X 1-9/16in Truss Head Machine Screw	N/A
BP7414320MBMB	Pull	Matte Black	12-5/8 (320) CTC	15-3/4 (400)	3/8 (10)	1-3/16 (30)	1 L x 1 W (25 L x 25 W)	Aluminum	(2) M4 X 1in Truss Head Machine Screw (2) M4 X 1-9/16in Truss Head Machine Screw	N/A
BP7414320MBMG	Pull	Matte Black/ Matte Gold	12-5/8 (320) CTC	15-3/4 (400)	3/8 (10)	1-3/16 (30)	1 L x 1 W (25 L x 25 W)	Aluminum	(2) M4 X 1in Truss Head Machine Screw (2) M4 X 1-9/16in Truss Head Machine Screw	N/A
BP7414320MBPN	Pull	Matte Black/ Polished Nickel	12-5/8 (320) CTC	15-3/4 (400)	3/8 (10)	1-3/16 (30)	1 L x 1 W (25 L x 25 W)	Aluminum	(2) M4 X 1in Truss Head Machine Screw (2) M4 X 1-9/16in Truss Head Machine Screw	N/A
BP7414320MBSC	Pull	Matte Black/ Silver Champagne	12-5/8 (320) CTC	15-3/4 (400)	3/8 (10)	1-3/16 (30)	1 L x 1 W (25 L x 25 W)	Aluminum	(2) M4 X 1in Truss Head Machine Screw (2) M4 X 1-9/16in Truss Head Machine Screw	N/A
BP7414320MGMG	Pull	Matte Gold	12-5/8 (320) CTC	15-3/4 (400)	3/8 (10)	1-3/16 (30)	1 L x 1 W (25 L x 25 W)	Aluminum	(2) M4 X 1in Truss Head Machine Screw (2) M4 X 1-9/16in Truss Head Machine Screw	N/A

Mounting hardware included.  
The dimensional information provided here should be verified with the actual product prior to drilling or attempting to install the hardware.  
Please direct any questions you may have on the installation process to Amerock Customer Service (see back cover for contact information).

# PRODUCT INDEX

Product No.	Type	Finish	Product Detail in (mm)	Length in (mm)	Width in (mm)	Projection in (mm)	Base Dimensions in (mm)	Base Material	Mounting Hardware Included	ADA-Friendly
<b>Transcendent (continued) • p. 68</b>										
BP7414320PNPN	Pull	Polished Nickel	12-5/8 (320) CTC	15-3/4 (400)	3/8 (10)	1-3/16 (30)	1 L x 1 W (25 L x 25 W)	Aluminum	(2) M4 X 1in Truss Head Machine Screw (2) M4 X 1-9/16in Truss Head Machine Screw	N/A
BP7414320SCSC	Pull	Silver Champagne	12-5/8 (320) CTC	15-3/4 (400)	3/8 (10)	1-3/16 (30)	1 L x 1 W (25 L x 25 W)	Aluminum	(2) M4 X 1in Truss Head Machine Screw (2) M4 X 1-9/16in Truss Head Machine Screw	N/A
BP741496MBMB	Pull	Matte Black	3-3/4 (96) CTC	6-15/16 (176)	3/8 (10)	1-3/16 (30)	1 L x 1 W (25 L x 25 W)	Aluminum	(2) M4 X 1in Truss Head Machine Screw (2) M4 X 1-9/16in Truss Head Machine Screw	N/A
BP741496MBMG	Pull	Matte Black/ Matte Gold	3-3/4 (96) CTC	6-15/16 (176)	3/8 (10)	1-3/16 (30)	1 L x 1 W (25 L x 25 W)	Aluminum	(2) M4 X 1in Truss Head Machine Screw (2) M4 X 1-9/16in Truss Head Machine Screw	N/A
BP741496MBPN	Pull	Matte Black/ Polished Nickel	3-3/4 (96) CTC	6-15/16 (176)	3/8 (10)	1-3/16 (30)	1 L x 1 W (25 L x 25 W)	Aluminum	(2) M4 X 1in Truss Head Machine Screw (2) M4 X 1-9/16in Truss Head Machine Screw	N/A
BP741496MBSC	Pull	Matte Black/ Silver Champagne	3-3/4 (96) CTC	6-15/16 (176)	3/8 (10)	1-3/16 (30)	1 L x 1 W (25 L x 25 W)	Aluminum	(2) M4 X 1in Truss Head Machine Screw (2) M4 X 1-9/16in Truss Head Machine Screw	N/A
BP741496MGMG	Pull	Matte Gold	3-3/4 (96) CTC	6-15/16 (176)	3/8 (10)	1-3/16 (30)	1 L x 1 W (25 L x 25 W)	Aluminum	(2) M4 X 1in Truss Head Machine Screw (2) M4 X 1-9/16in Truss Head Machine Screw	N/A
BP741496PNPN	Pull	Polished Nickel	3-3/4 (96) CTC	6-15/16 (176)	3/8 (10)	1-3/16 (30)	1 L x 1 W (25 L x 25 W)	Aluminum	(2) M4 X 1in Truss Head Machine Screw (2) M4 X 1-9/16in Truss Head Machine Screw	N/A
BP741496SCSC	Pull	Silver Champagne	3-3/4 (96) CTC	6-15/16 (176)	3/8 (10)	1-3/16 (30)	1 L x 1 W (25 L x 25 W)	Aluminum	(2) M4 X 1in Truss Head Machine Screw (2) M4 X 1-9/16in Truss Head Machine Screw	N/A
<b>Bar Pulls • p. 70</b>										
BP1900926	Knob	Polished Chrome	1-15/16 (49) LGTH	1-15/16 (49)	1/2 (13)	1-3/8 (35)	3/8 L x 3/8 W (10 L x 10 W)	Carbon Steel	(1) #8-32 x 1in Truss Head Machine Screw (1) #8-32 x 1-1/2in Truss Head Machine Screw	N/A
BP19009BBR	Knob	Black Bronze	1-15/16 (49) LGTH	1-15/16 (49)	1/2 (13)	1-3/8 (35)	3/8 L x 3/8 W (10 L x 10 W)	Carbon Steel	(1) #8-32 x 1in Truss Head Machine Screw (1) #8-32 x 1-1/2in Truss Head Machine Screw	N/A
BP19009BBZ	Knob	Golden Champagne	1-15/16 (49) LGTH	1-15/16 (49)	1/2 (13)	1-3/8 (35)	3/8 L x 3/8 W (10 L x 10 W)	Carbon Steel	(1) #8-32 x 1in Truss Head Machine Screw (1) #8-32 x 1-1/2in Truss Head Machine Screw	N/A
BP19009CSG9	Knob	Sterling Nickel	1-15/16 (49) LGTH	1-15/16 (49)	1/2 (13)	1-3/8 (35)	3/8 L x 3/8 W (10 L x 10 W)	Carbon Steel	(1) #8-32 x 1in Truss Head Machine Screw (1) #8-32 x 1-1/2in Truss Head Machine Screw	N/A
BP19009CZ	Knob	Champagne Bronze	1-15/16 (49) LGTH	1-15/16 (49)	1/2 (13)	1-3/8 (35)	3/8 L x 3/8 W (10 L x 10 W)	Carbon Steel	(1) #8-32 x 1in Truss Head Machine Screw (1) #8-32 x 1-1/2in Truss Head Machine Screw	N/A
BP19009GM	Knob	Gunmetal	1-15/16 (49) LGTH	1-15/16 (49)	1/2 (13)	1-3/8 (35)	3/8 L x 3/8 W (10 L x 10 W)	Carbon Steel	(1) #8-32 x 1in Truss Head Machine Screw (1) #8-32 x 1-1/2in Truss Head Machine Screw	N/A
BP19009ORB	Knob	Oil-Rubbed Bronze	1-15/16 (49) LGTH	1-15/16 (49)	1/2 (13)	1-3/8 (35)	3/8 L x 3/8 W (10 L x 10 W)	Carbon Steel	(1) #8-32 x 1in Truss Head Machine Screw (1) #8-32 x 1-1/2in Truss Head Machine Screw	N/A
BP19009PN	Knob	Polished Nickel	1-15/16 (49) LGTH	1-15/16 (49)	1/2 (13)	1-3/8 (35)	3/8 L x 3/8 W (10 L x 10 W)	Carbon Steel	(1) #8-32 x 1in Truss Head Machine Screw (1) #8-32 x 1-1/2in Truss Head Machine Screw	N/A
BP19009SS	Knob	Stainless Steel	1-15/16 (49) LGTH	1-15/16 (49)	1/2 (13)	1-3/8 (35)	3/8 L x 3/8 W (10 L x 10 W)	Stainless Steel	(1) #8-32 x 1in Truss Head Machine Screw (1) #8-32 x 1-1/2in Truss Head Machine Screw	N/A
BP19010CSG9	Pull	Sterling Nickel	3 (76) CTC	5-3/8 (137)	1/2 (13)	1-3/8 (35)	3/8 L x 3/8 W (10 L x 10 W)	Carbon Steel	(2) #8-32 x 1in Truss Head Machine Screw (2) #8-32 x 1-1/2in Truss Head Machine Screw	N/A
BP19010SS	Pull	Stainless Steel	3 (76) CTC	5-3/8 (137)	1/2 (13)	1-3/8 (35)	3/8 L x 3/8 W (10 L x 10 W)	Stainless Steel	(2) #8-32 x 1in Truss Head Machine Screw (2) #8-32 x 1-1/2in Truss Head Machine Screw	N/A
BP19011CSG9	Pull	Sterling Nickel	3-3/4 (96) CTC	6-1/8 (156)	1/2 (13)	1-3/8 (35)	3/8 L x 3/8 W (10 L x 10 W)	Carbon Steel	(2) #8-32 x 1in Truss Head Machine Screw (2) #8-32 x 1-1/2in Truss Head Machine Screw	N/A
BP19011SS	Pull	Stainless Steel	3-3/4 (96) CTC	6-1/8 (156)	1/2 (13)	1-3/8 (35)	3/8 L x 3/8 W (10 L x 10 W)	Stainless Steel	(2) #8-32 x 1in Truss Head Machine Screw (2) #8-32 x 1-1/2in Truss Head Machine Screw	N/A
BP19012CSG9	Pull	Sterling Nickel	7-9/16 (192) CTC	9-15/16 (252)	1/2 (13)	1-3/8 (35)	3/8 L x 3/8 W (10 L x 10 W)	Carbon Steel	(2) #8-32 x 1in Truss Head Machine Screw (2) #8-32 x 1-1/2in Truss Head Machine Screw	N/A

Mounting hardware included.  
The dimensional information provided here should be verified with the actual product prior to drilling or attempting to install the hardware.  
Please direct any questions you may have on the installation process to Amerock Customer Service (see back cover for contact information).

# PRODUCT INDEX

Product No.	Type	Finish	Product Detail in (mm)	Length in (mm)	Width in (mm)	Projection in (mm)	Base Dimensions in (mm)	Base Material	Mounting Hardware Included	ADA-Friendly
<b>Bar Pulls (continued) • p. 70</b>										
BP19012SS	Pull	Stainless Steel	7-9/16 (192) CTC	9-15/16 (252)	1/2 (13)	1-3/8 (35)	3/8 L x 3/8 W (10 L x 10 W)	Stainless Steel	(2) #8-32 x 1in Truss Head Machine Screw (2) #8-32 x 1-1/2in Truss Head Machine Screw	N/A
BP19013CSG9	Pull	Sterling Nickel	10-1/16 (256) CTC	13-1/4 (337)	1/2 (13)	1-3/8 (35)	3/8 L x 3/8 W (10 L x 10 W)	Carbon Steel	(2) #8-32 x 1in Truss Head Machine Screw (2) #8-32 x 1-1/2in Truss Head Machine Screw	N/A
BP19013SS	Pull	Stainless Steel	10-1/16 (256) CTC	13-1/4 (337)	1/2 (13)	1-3/8 (35)	3/8 L x 3/8 W (10 L x 10 W)	Stainless Steel	(2) #8-32 x 1in Truss Head Machine Screw (2) #8-32 x 1-1/2in Truss Head Machine Screw	N/A
BP1901426	Pull	Polished Chrome	12-5/8 (320) CTC	15-3/4 (400)	1/2 (13)	1-3/8 (35)	3/8 L x 3/8 W (10 L x 10 W)	Carbon Steel	(2) #8-32 x 1in Truss Head Machine Screw (2) #8-32 x 1-1/2in Truss Head Machine Screw	N/A
BP19014BBR	Pull	Black Bronze	12-5/8 (320) CTC	15-3/4 (400)	1/2 (13)	1-3/8 (35)	3/8 L x 3/8 W (10 L x 10 W)	Carbon Steel	(2) #8-32 x 1in Truss Head Machine Screw (2) #8-32 x 1-1/2in Truss Head Machine Screw	N/A
BP19014BBZ	Pull	Golden Champagne	12-5/8 (320) CTC	15-3/4 (400)	1/2 (13)	1-3/8 (35)	3/8 L x 3/8 W (10 L x 10 W)	Carbon Steel	(2) #8-32 x 1in Truss Head Machine Screw (2) #8-32 x 1-1/2in Truss Head Machine Screw	N/A
BP19014CSG9	Pull	Sterling Nickel	12-5/8 (320) CTC	15-3/4 (400)	1/2 (13)	1-3/8 (35)	3/8 L x 3/8 W (10 L x 10 W)	Carbon Steel	(2) #8-32 x 1in Truss Head Machine Screw (2) #8-32 x 1-1/2in Truss Head Machine Screw	N/A
BP19014CZ	Pull	Champagne Bronze	12-5/8 (320) CTC	15-3/4 (400)	1/2 (13)	1-3/8 (35)	3/8 L x 3/8 W (10 L x 10 W)	Carbon Steel	(2) #8-32 x 1in Truss Head Machine Screw (2) #8-32 x 1-1/2in Truss Head Machine Screw	N/A
BP19014GM	Pull	Gunmetal	12-5/8 (320) CTC	15-3/4 (400)	1/2 (13)	1-3/8 (35)	3/8 L x 3/8 W (10 L x 10 W)	Carbon Steel	(2) #8-32 x 1in Truss Head Machine Screw (2) #8-32 x 1-1/2in Truss Head Machine Screw	N/A
BP19014ORB	Pull	Oil-Rubbed Bronze	12-5/8 (320) CTC	15-3/4 (400)	1/2 (13)	1-3/8 (35)	3/8 L x 3/8 W (10 L x 10 W)	Carbon Steel	(2) #8-32 x 1in Truss Head Machine Screw (2) #8-32 x 1-1/2in Truss Head Machine Screw	N/A
BP19014PN	Pull	Polished Nickel	12-5/8 (320) CTC	15-3/4 (400)	1/2 (13)	1-3/8 (35)	3/8 L x 3/8 W (10 L x 10 W)	Carbon Steel	(2) #8-32 x 1in Truss Head Machine Screw (2) #8-32 x 1-1/2in Truss Head Machine Screw	N/A
BP19014SS	Pull	Stainless Steel	12-5/8 (320) CTC	15-3/4 (400)	1/2 (13)	1-3/8 (35)	3/8 L x 3/8 W (10 L x 10 W)	Stainless Steel	(2) #8-32 x 1in Truss Head Machine Screw (2) #8-32 x 1-1/2in Truss Head Machine Screw	N/A
BP19015CSG9	Pull	Sterling Nickel	16-3/8 (416) CTC	19-1/2 (495)	1/2 (13)	1-3/8 (35)	3/8 L x 3/8 W (10 L x 10 W)	Carbon Steel	(2) #8-32 x 1in Truss Head Machine Screw (2) #8-32 x 1-1/2in Truss Head Machine Screw	N/A
BP19015ORB	Pull	Oil-Rubbed Bronze	16-3/8 (416) CTC	19-1/2 (495)	1/2 (13)	1-3/8 (35)	3/8 L x 3/8 W (10 L x 10 W)	Carbon Steel	(2) #8-32 x 1in Truss Head Machine Screw (2) #8-32 x 1-1/2in Truss Head Machine Screw	N/A
BP19015SS	Pull	Stainless Steel	16-3/8 (416) CTC	19-1/2 (495)	1/2 (13)	1-3/8 (35)	3/8 L x 3/8 W (10 L x 10 W)	Stainless Steel	(2) #8-32 x 1in Truss Head Machine Screw (2) #8-32 x 1-1/2in Truss Head Machine Screw	N/A
BP1901626	Pull	Polished Chrome	18-7/8 (480) CTC	22-1/16 (560)	1/2 (13)	1-3/8 (35)	3/8 L x 3/8 W (10 L x 10 W)	Carbon Steel	(2) #8-32 x 1in Truss Head Machine Screw (2) #8-32 x 1-1/2in Truss Head Machine Screw	N/A
BP19016BBR	Pull	Black Bronze	18-7/8 (480) CTC	22-1/16 (560)	1/2 (13)	1-3/8 (35)	3/8 L x 3/8 W (10 L x 10 W)	Carbon Steel	(2) #8-32 x 1in Truss Head Machine Screw (2) #8-32 x 1-1/2in Truss Head Machine Screw	N/A
BP19016BBZ	Pull	Golden Champagne	18-7/8 (480) CTC	22-1/16 (560)	1/2 (13)	1-3/8 (35)	3/8 L x 3/8 W (10 L x 10 W)	Carbon Steel	(2) #8-32 x 1in Truss Head Machine Screw (2) #8-32 x 1-1/2in Truss Head Machine Screw	N/A
BP19016CSG9	Pull	Sterling Nickel	18-7/8 (480) CTC	22-1/16 (560)	1/2 (13)	1-3/8 (35)	3/8 L x 3/8 W (10 L x 10 W)	Carbon Steel	(2) #8-32 x 1in Truss Head Machine Screw (2) #8-32 x 1-1/2in Truss Head Machine Screw	N/A
BP19016CZ	Pull	Champagne Bronze	18-7/8 (480) CTC	22-1/16 (560)	1/2 (13)	1-3/8 (35)	3/8 L x 3/8 W (10 L x 10 W)	Carbon Steel	(2) #8-32 x 1in Truss Head Machine Screw (2) #8-32 x 1-1/2in Truss Head Machine Screw	N/A
BP19016GM	Pull	Gunmetal	18-7/8 (480) CTC	22-1/16 (560)	1/2 (13)	1-3/8 (35)	3/8 L x 3/8 W (10 L x 10 W)	Carbon Steel	(2) #8-32 x 1in Truss Head Machine Screw (2) #8-32 x 1-1/2in Truss Head Machine Screw	N/A
BP19016ORB	Pull	Oil-Rubbed Bronze	18-7/8 (480) CTC	22-1/16 (560)	1/2 (13)	1-3/8 (35)	3/8 L x 3/8 W (10 L x 10 W)	Carbon Steel	(2) #8-32 x 1in Truss Head Machine Screw (2) #8-32 x 1-1/2in Truss Head Machine Screw	N/A
BP19016PN	Pull	Polished Nickel	18-7/8 (480) CTC	22-1/16 (560)	1/2 (13)	1-3/8 (35)	3/8 L x 3/8 W (10 L x 10 W)	Carbon Steel	(2) #8-32 x 1in Truss Head Machine Screw (2) #8-32 x 1-1/2in Truss Head Machine Screw	N/A
BP19016SS	Pull	Stainless Steel	18-7/8 (480) CTC	22-1/16 (560)	1/2 (13)	1-3/8 (35)	3/8 L x 3/8 W (10 L x 10 W)	Stainless Steel	(2) #8-32 x 1in Truss Head Machine Screw (2) #8-32 x 1-1/2in Truss Head Machine Screw	N/A
BP19017CSG9	Pull	Sterling Nickel	21-7/16 (544) CTC	24-9/16 (624)	1/2 (13)	1-3/8 (35)	3/8 L x 3/8 W (10 L x 10 W)	Carbon Steel	(2) #8-32 x 1in Truss Head Machine Screw (2) #8-32 x 1-1/2in Truss Head Machine Screw	N/A

Mounting hardware included.  
The dimensional information provided here should be verified with the actual product prior to drilling or attempting to install the hardware.  
Please direct any questions you may have on the installation process to Amerock Customer Service (see back cover for contact information).

# PRODUCT INDEX

Product No.	Type	Finish	Product Detail in (mm)	Length in (mm)	Width in (mm)	Projection in (mm)	Base Dimensions in (mm)	Base Material	Mounting Hardware Included	ADA-Friendly
<b>Bar Pulls (continued) • p. 70</b>										
BP19017ORB	Pull	Oil-Rubbed Bronze	21-7/16 (544) CTC	24-9/16 (624)	1/2 (13)	1-3/8 (35)	3/8 L x 3/8 W (10 L x 10 W)	Carbon Steel	(2) #8-32 x 1in Truss Head Machine Screw (2) #8-32 x 1-1/2in Truss Head Machine Screw	N/A
BP19017SS	Pull	Stainless Steel	21-7/16 (544) CTC	24-9/16 (624)	1/2 (13)	1-3/8 (35)	3/8 L x 3/8 W (10 L x 10 W)	Stainless Steel	(2) #8-32 x 1in Truss Head Machine Screw (2) #8-32 x 1-1/2in Truss Head Machine Screw	N/A
BP19018CSG9	Pull	Sterling Nickel	25-3/16 (640) CTC	28-5/16 (719)	1/2 (13)	1-3/8 (35)	3/8 L x 3/8 W (10 L x 10 W)	Carbon Steel	(2) #8-32 x 1in Truss Head Machine Screw (2) #8-32 x 1-1/2in Truss Head Machine Screw	N/A
BP19018ORB	Pull	Oil-Rubbed Bronze	25-3/16 (640) CTC	28-5/16 (719)	1/2 (13)	1-3/8 (35)	3/8 L x 3/8 W (10 L x 10 W)	Carbon Steel	(2) #8-32 x 1in Truss Head Machine Screw (2) #8-32 x 1-1/2in Truss Head Machine Screw	N/A
BP19018SS	Pull	Stainless Steel	25-3/16 (640) CTC	28-5/16 (719)	1/2 (13)	1-3/8 (35)	3/8 L x 3/8 W (10 L x 10 W)	Stainless Steel	(2) #8-32 x 1in Truss Head Machine Screw (2) #8-32 x 1-1/2in Truss Head Machine Screw	N/A
BP19019CSG9	Pull	Sterling Nickel	30-1/4 (768) CTC	33-7/16 (849)	1/2 (13)	1-3/8 (35)	3/8 L x 3/8 W (10 L x 10 W)	Carbon Steel	(2) #8-32 x 1in Truss Head Machine Screw (2) #8-32 x 1-1/2in Truss Head Machine Screw	N/A
BP19019ORB	Pull	Oil-Rubbed Bronze	30-1/4 (768) CTC	33-7/16 (849)	1/2 (13)	1-3/8 (35)	3/8 L x 3/8 W (10 L x 10 W)	Carbon Steel	(2) #8-32 x 1in Truss Head Machine Screw (2) #8-32 x 1-1/2in Truss Head Machine Screw	N/A
BP19019SS	Pull	Stainless Steel	30-1/4 (768) CTC	33-7/16 (849)	1/2 (13)	1-3/8 (35)	3/8 L x 3/8 W (10 L x 10 W)	Stainless Steel	(2) #8-32 x 1in Truss Head Machine Screw (2) #8-32 x 1-1/2in Truss Head Machine Screw	N/A
BP19541CSG9	Pull	Sterling Nickel	5-1/16 (128) CTC	7-3/8 (187)	1/2 (13)	1-3/8 (35)	3/8 L x 3/8 W (10 L x 10 W)	Carbon Steel	(2) #8-32 x 1in Truss Head Machine Screw (2) #8-32 x 1-1/2in Truss Head Machine Screw	N/A
BP19541SS	Pull	Stainless Steel	5-1/16 (128) CTC	7-3/8 (187)	1/2 (13)	1-3/8 (35)	3/8 L x 3/8 W (10 L x 10 W)	Stainless Steel	(2) #8-32 x 1in Truss Head Machine Screw (2) #8-32 x 1-1/2in Truss Head Machine Screw	N/A
BP4051526	Pull	Polished Chrome	3 (76) CTC	5-3/8 (137)	1/2 (13)	1-3/8 (35)	3/8 L x 3/8 W (10 L x 10 W)	Carbon Steel	(2) #8-32 x 1in Truss Head Machine Screw (2) #8-32 x 1-1/2in Truss Head Machine Screw	N/A
BP40515BBR	Pull	Black Bronze	3 (76) CTC	5-3/8 (137)	1/2 (13)	1-3/8 (35)	3/8 L x 3/8 W (10 L x 10 W)	Carbon Steel	(2) #8-32 x 1in Truss Head Machine Screw (2) #8-32 x 1-1/2in Truss Head Machine Screw	N/A
BP40515BBZ	Pull	Golden Champagne	3 (76) CTC	5-3/8 (137)	1/2 (13)	1-3/8 (35)	3/8 L x 3/8 W (10 L x 10 W)	Carbon Steel	(2) #8-32 x 1in Truss Head Machine Screw (2) #8-32 x 1-1/2in Truss Head Machine Screw	N/A
BP40515CBZ	Pull	Caramel Bronze	3 (76) CTC	5-3/8 (137)	1/2 (13)	1-3/8 (35)	3/8 L x 3/8 W (10 L x 10 W)	Carbon Steel	(2) #8-32 x 1in Truss Head Machine Screw (2) #8-32 x 1-1/2in Truss Head Machine Screw	N/A
BP40515CZ	Pull	Champagne Bronze	3 (76) CTC	5-3/8 (137)	1/2 (13)	1-3/8 (35)	3/8 L x 3/8 W (10 L x 10 W)	Carbon Steel	(2) #8-32 x 1in Truss Head Machine Screw (2) #8-32 x 1-1/2in Truss Head Machine Screw	N/A
BP40515GM	Pull	Gunmetal	3 (76) CTC	5-3/8 (137)	1/2 (13)	1-3/8 (35)	3/8 L x 3/8 W (10 L x 10 W)	Carbon Steel	(2) #8-32 x 1in Truss Head Machine Screw (2) #8-32 x 1-1/2in Truss Head Machine Screw	N/A
BP40515ORB	Pull	Oil-Rubbed Bronze	3 (76) CTC	5-3/8 (137)	1/2 (13)	1-3/8 (35)	3/8 L x 3/8 W (10 L x 10 W)	Carbon Steel	(2) #8-32 x 1in Truss Head Machine Screw (2) #8-32 x 1-1/2in Truss Head Machine Screw	N/A
BP40515PN	Pull	Polished Nickel	3 (76) CTC	5-3/8 (137)	1/2 (13)	1-3/8 (35)	3/8 L x 3/8 W (10 L x 10 W)	Carbon Steel	(2) #8-32 x 1in Truss Head Machine Screw (2) #8-32 x 1-1/2in Truss Head Machine Screw	N/A
BP4051626	Pull	Polished Chrome	3-3/4 (96) CTC	6-1/8 (156)	1/2 (13)	1-3/8 (35)	3/8 L x 3/8 W (10 L x 10 W)	Carbon Steel	(2) #8-32 x 1in Truss Head Machine Screw (2) #8-32 x 1-1/2in Truss Head Machine Screw	N/A
BP40516BBR	Pull	Black Bronze	3-3/4 (96) CTC	6-1/8 (156)	1/2 (13)	1-3/8 (35)	3/8 L x 3/8 W (10 L x 10 W)	Carbon Steel	(2) #8-32 x 1in Truss Head Machine Screw (2) #8-32 x 1-1/2in Truss Head Machine Screw	N/A
BP40516BBZ	Pull	Golden Champagne	3-3/4 (96) CTC	6-1/8 (156)	1/2 (13)	1-3/8 (35)	3/8 L x 3/8 W (10 L x 10 W)	Carbon Steel	(2) #8-32 x 1in Truss Head Machine Screw (2) #8-32 x 1-1/2in Truss Head Machine Screw	N/A
BP40516CZ	Pull	Champagne Bronze	3-3/4 (96) CTC	6-1/8 (156)	1/2 (13)	1-3/8 (35)	3/8 L x 3/8 W (10 L x 10 W)	Carbon Steel	(2) #8-32 x 1in Truss Head Machine Screw (2) #8-32 x 1-1/2in Truss Head Machine Screw	N/A
BP40516GM	Pull	Gunmetal	3-3/4 (96) CTC	6-1/8 (156)	1/2 (13)	1-3/8 (35)	3/8 L x 3/8 W (10 L x 10 W)	Carbon Steel	(2) #8-32 x 1in Truss Head Machine Screw (2) #8-32 x 1-1/2in Truss Head Machine Screw	N/A
BP40516ORB	Pull	Oil-Rubbed Bronze	3-3/4 (96) CTC	6-1/8 (156)	1/2 (13)	1-3/8 (35)	3/8 L x 3/8 W (10 L x 10 W)	Carbon Steel	(2) #8-32 x 1in Truss Head Machine Screw (2) #8-32 x 1-1/2in Truss Head Machine Screw	N/A
BP40516PN	Pull	Polished Nickel	3-3/4 (96) CTC	6-1/8 (156)	1/2 (13)	1-3/8 (35)	3/8 L x 3/8 W (10 L x 10 W)	Carbon Steel	(2) #8-32 x 1in Truss Head Machine Screw (2) #8-32 x 1-1/2in Truss Head Machine Screw	N/A

Mounting hardware included.  
The dimensional information provided here should be verified with the actual product prior to drilling or attempting to install the hardware.  
Please direct any questions you may have on the installation process to Amerock Customer Service (see back cover for contact information).

# PRODUCT INDEX

Product No.	Type	Finish	Product Detail in (mm)	Length in (mm)	Width in (mm)	Projection in (mm)	Base Dimensions in (mm)	Base Material	Mounting Hardware Included	ADA-Friendly
<b>Bar Pulls (continued) • p. 70</b>										
BP4051726	Pull	Polished Chrome	5-1/16 (128) CTC	7-3/8 (187)	1/2 (13)	1-3/8 (35)	3/8 L x 3/8 W (10 L x 10 W)	Carbon Steel	(2) #8-32 x 1in Truss Head Machine Screw (2) #8-32 x 1-1/2in Truss Head Machine Screw	N/A
BP40517BBR	Pull	Black Bronze	5-1/16 (128) CTC	7-3/8 (187)	1/2 (13)	1-3/8 (35)	3/8 L x 3/8 W (10 L x 10 W)	Carbon Steel	(2) #8-32 x 1in Truss Head Machine Screw (2) #8-32 x 1-1/2in Truss Head Machine Screw	N/A
BP40517BBZ	Pull	Golden Champagne	5-1/16 (128) CTC	7-3/8 (187)	1/2 (13)	1-3/8 (35)	3/8 L x 3/8 W (10 L x 10 W)	Carbon Steel	(2) #8-32 x 1in Truss Head Machine Screw (2) #8-32 x 1-1/2in Truss Head Machine Screw	N/A
BP40517CZ	Pull	Champagne Bronze	5-1/16 (128) CTC	7-3/8 (187)	1/2 (13)	1-3/8 (35)	3/8 L x 3/8 W (10 L x 10 W)	Carbon Steel	(2) #8-32 x 1in Truss Head Machine Screw (2) #8-32 x 1-1/2in Truss Head Machine Screw	N/A
BP40517GM	Pull	Gunmetal	5-1/16 (128) CTC	7-3/8 (187)	1/2 (13)	1-3/8 (35)	3/8 L x 3/8 W (10 L x 10 W)	Carbon Steel	(2) #8-32 x 1in Truss Head Machine Screw (2) #8-32 x 1-1/2in Truss Head Machine Screw	N/A
BP40517ORB	Pull	Oil-Rubbed Bronze	5-1/16 (128) CTC	7-3/8 (187)	1/2 (13)	1-3/8 (35)	3/8 L x 3/8 W (10 L x 10 W)	Carbon Steel	(2) #8-32 x 1in Truss Head Machine Screw (2) #8-32 x 1-1/2in Truss Head Machine Screw	N/A
BP40517PN	Pull	Polished Nickel	5-1/16 (128) CTC	7-3/8 (187)	1/2 (13)	1-3/8 (35)	3/8 L x 3/8 W (10 L x 10 W)	Carbon Steel	(2) #8-32 x 1in Truss Head Machine Screw (2) #8-32 x 1-1/2in Truss Head Machine Screw	N/A
BP4051826	Pull	Polished Chrome	7-9/16 (192) CTC	9-15/16 (252)	1/2 (13)	1-3/8 (35)	3/8 L x 3/8 W (10 L x 10 W)	Carbon Steel	(2) #8-32 x 1in Truss Head Machine Screw (2) #8-32 x 1-1/2in Truss Head Machine Screw	N/A
BP40518BBR	Pull	Black Bronze	7-9/16 (192) CTC	9-15/16 (252)	1/2 (13)	1-3/8 (35)	3/8 L x 3/8 W (10 L x 10 W)	Carbon Steel	(2) #8-32 x 1in Truss Head Machine Screw (2) #8-32 x 1-1/2in Truss Head Machine Screw	N/A
BP40518BBZ	Pull	Golden Champagne	7-9/16 (192) CTC	9-15/16 (252)	1/2 (13)	1-3/8 (35)	3/8 L x 3/8 W (10 L x 10 W)	Carbon Steel	(2) #8-32 x 1in Truss Head Machine Screw (2) #8-32 x 1-1/2in Truss Head Machine Screw	N/A
BP40518CZ	Pull	Champagne Bronze	7-9/16 (192) CTC	9-15/16 (252)	1/2 (13)	1-3/8 (35)	3/8 L x 3/8 W (10 L x 10 W)	Carbon Steel	(2) #8-32 x 1in Truss Head Machine Screw (2) #8-32 x 1-1/2in Truss Head Machine Screw	N/A
BP40518GM	Pull	Gunmetal	7-9/16 (192) CTC	9-15/16 (252)	1/2 (13)	1-3/8 (35)	3/8 L x 3/8 W (10 L x 10 W)	Carbon Steel	(2) #8-32 x 1in Truss Head Machine Screw (2) #8-32 x 1-1/2in Truss Head Machine Screw	N/A
BP40518ORB	Pull	Oil-Rubbed Bronze	7-9/16 (192) CTC	9-15/16 (252)	1/2 (13)	1-3/8 (35)	3/8 L x 3/8 W (10 L x 10 W)	Carbon Steel	(2) #8-32 x 1in Truss Head Machine Screw (2) #8-32 x 1-1/2in Truss Head Machine Screw	N/A
BP40518PN	Pull	Polished Nickel	7-9/16 (192) CTC	9-15/16 (252)	1/2 (13)	1-3/8 (35)	3/8 L x 3/8 W (10 L x 10 W)	Carbon Steel	(2) #8-32 x 1in Truss Head Machine Screw (2) #8-32 x 1-1/2in Truss Head Machine Screw	N/A
BP4051926	Pull	Polished Chrome	10-1/16 (256) CTC	13-1/4 (337)	1/2 (13)	1-3/8 (35)	3/8 L x 3/8 W (10 L x 10 W)	Carbon Steel	(2) #8-32 x 1in Truss Head Machine Screw (2) #8-32 x 1-1/2in Truss Head Machine Screw	N/A
BP40519BBR	Pull	Black Bronze	10-1/16 (256) CTC	13-1/4 (337)	1/2 (13)	1-3/8 (35)	3/8 L x 3/8 W (10 L x 10 W)	Carbon Steel	(2) #8-32 x 1in Truss Head Machine Screw (2) #8-32 x 1-1/2in Truss Head Machine Screw	N/A
BP40519BBZ	Pull	Golden Champagne	10-1/16 (256) CTC	13-1/4 (337)	1/2 (13)	1-3/8 (35)	3/8 L x 3/8 W (10 L x 10 W)	Carbon Steel	(2) #8-32 x 1in Truss Head Machine Screw (2) #8-32 x 1-1/2in Truss Head Machine Screw	N/A
BP40519CZ	Pull	Champagne Bronze	10-1/16 (256) CTC	13-1/4 (337)	1/2 (13)	1-3/8 (35)	3/8 L x 3/8 W (10 L x 10 W)	Carbon Steel	(2) #8-32 x 1in Truss Head Machine Screw (2) #8-32 x 1-1/2in Truss Head Machine Screw	N/A
BP40519GM	Pull	Gunmetal	10-1/16 (256) CTC	13-1/4 (337)	1/2 (13)	1-3/8 (35)	3/8 L x 3/8 W (10 L x 10 W)	Carbon Steel	(2) #8-32 x 1in Truss Head Machine Screw (2) #8-32 x 1-1/2in Truss Head Machine Screw	N/A
BP40519ORB	Pull	Oil-Rubbed Bronze	10-1/16 (256) CTC	13-1/4 (337)	1/2 (13)	1-3/8 (35)	3/8 L x 3/8 W (10 L x 10 W)	Carbon Steel	(2) #8-32 x 1in Truss Head Machine Screw (2) #8-32 x 1-1/2in Truss Head Machine Screw	N/A
BP40519PN	Pull	Polished Nickel	10-1/16 (256) CTC	13-1/4 (337)	1/2 (13)	1-3/8 (35)	3/8 L x 3/8 W (10 L x 10 W)	Carbon Steel	(2) #8-32 x 1in Truss Head Machine Screw (2) #8-32 x 1-1/2in Truss Head Machine Screw	N/A
BP54008BBR	Appliance Pull	Black Bronze	12 (305) CTC	14-5/8 (371)	3/4 (19)	2 (51)	5/8 L x 5/8 W (16 L x 16 W)	Carbon Steel	(2) #10-24 x 3/4in Pan Head Machine Screw (2) #10-24 x 1in Pan Head Machine Screw (2) #10-24 x 1-1/4in Pan Head Machine Screw (2) #10-24 x 1-1/2in Pan Head Machine Screw (2) #10-24 x 1-3/4in Pan Head Machine Screw	N/A

Mounting hardware included.  
The dimensional information provided here should be verified with the actual product prior to drilling or attempting to install the hardware.  
Please direct any questions you may have on the installation process to Amerock Customer Service (see back cover for contact information).



# PRODUCT INDEX

Product No.	Type	Finish	Product Detail in (mm)	Length in (mm)	Width in (mm)	Projection in (mm)	Base Dimensions in (mm)	Base Material	Mounting Hardware Included	ADA-Friendly
<b>Bar Pulls (continued) • p. 70</b>										
BP54008BBZ	Appliance Pull	Golden Champagne	12 (305) CTC	14-5/8 (371)	3/4 (19)	2 (51)	5/8 L x 5/8 W (16 L x 16 W)	Carbon Steel	(2) #10-24 x 3/4in Pan Head Machine Screw (2) #10-24 x 1in Pan Head Machine Screw (2) #10-24 x 1-1/4in Pan Head Machine Screw (2) #10-24 x 1-1/2in Pan Head Machine Screw (2) #10-24 x 1-3/4in Pan Head Machine Screw	N/A
BP54008CSG9	Appliance Pull	Sterling Nickel	12 (305) CTC	14-5/8 (371)	3/4 (19)	2 (51)	5/8 L x 5/8 W (16 L x 16 W)	Carbon Steel	(2) #10-24 x 3/4in Pan Head Machine Screw (2) #10-24 x 1in Pan Head Machine Screw (2) #10-24 x 1-1/4in Pan Head Machine Screw (2) #10-24 x 1-1/2in Pan Head Machine Screw (2) #10-24 x 1-3/4in Pan Head Machine Screw	N/A
BP54008GM	Appliance Pull	Gunmetal	12 (305) CTC	14-5/8 (371)	3/4 (19)	2 (51)	5/8 L x 5/8 W (16 L x 16 W)	Carbon Steel	(2) #10-24 x 3/4in Pan Head Machine Screw (2) #10-24 x 1in Pan Head Machine Screw (2) #10-24 x 1-1/4in Pan Head Machine Screw (2) #10-24 x 1-1/2in Pan Head Machine Screw (2) #10-24 x 1-3/4in Pan Head Machine Screw	N/A
BP54008ORB	Appliance Pull	Oil-Rubbed Bronze	12 (305) CTC	14-5/8 (371)	3/4 (19)	2 (51)	5/8 L x 5/8 W (16 L x 16 W)	Carbon Steel	(2) #10-24 x 3/4in Pan Head Machine Screw (2) #10-24 x 1in Pan Head Machine Screw (2) #10-24 x 1-1/4in Pan Head Machine Screw (2) #10-24 x 1-1/2in Pan Head Machine Screw (2) #10-24 x 1-3/4in Pan Head Machine Screw	N/A
BP54008PN	Appliance Pull	Polished Nickel	12 (305) CTC	14-5/8 (371)	3/4 (19)	2 (51)	5/8 L x 5/8 W (16 L x 16 W)	Carbon Steel	(2) #10-24 x 3/4in Pan Head Machine Screw (2) #10-24 x 1in Pan Head Machine Screw (2) #10-24 x 1-1/4in Pan Head Machine Screw (2) #10-24 x 1-1/2in Pan Head Machine Screw (2) #10-24 x 1-3/4in Pan Head Machine Screw	N/A
BP54008SS	Appliance Pull	Stainless Steel	12 (305) CTC	14-5/8 (371)	3/4 (19)	2 (51)	5/8 L x 5/8 W (16 L x 16 W)	Stainless Steel	(2) #10-24 x 3/4in Pan Head Machine Screw (2) #10-24 x 1in Pan Head Machine Screw (2) #10-24 x 1-1/4in Pan Head Machine Screw (2) #10-24 x 1-1/2in Pan Head Machine Screw (2) #10-24 x 1-3/4in Pan Head Machine Screw	N/A
BP54025BBR	Appliance Pull	Black Bronze	18 (457) CTC	20-5/8 (524)	3/4 (19)	2 (51)	5/8 L x 5/8 W (16 L x 16 W)	Carbon Steel	(2) #10-24 x 3/4in Pan Head Machine Screw (2) #10-24 x 1in Pan Head Machine Screw (2) #10-24 x 1-1/4in Pan Head Machine Screw (2) #10-24 x 1-1/2in Pan Head Machine Screw (2) #10-24 x 1-3/4in Pan Head Machine Screw	N/A
BP54025BBZ	Appliance Pull	Golden Champagne	18 (457) CTC	20-5/8 (524)	3/4 (19)	2 (51)	5/8 L x 5/8 W (16 L x 16 W)	Carbon Steel	(2) #10-24 x 3/4in Pan Head Machine Screw (2) #10-24 x 1in Pan Head Machine Screw (2) #10-24 x 1-1/4in Pan Head Machine Screw (2) #10-24 x 1-1/2in Pan Head Machine Screw (2) #10-24 x 1-3/4in Pan Head Machine Screw	N/A
BP54025ORB	Appliance Pull	Oil-Rubbed Bronze	18 (457) CTC	20-5/8 (524)	3/4 (19)	2 (51)	5/8 L x 5/8 W (16 L x 16 W)	Carbon Steel	(2) #10-24 x 3/4in Pan Head Machine Screw (2) #10-24 x 1in Pan Head Machine Screw (2) #10-24 x 1-1/4in Pan Head Machine Screw (2) #10-24 x 1-1/2in Pan Head Machine Screw (2) #10-24 x 1-3/4in Pan Head Machine Screw	N/A
BP54025PN	Appliance Pull	Polished Nickel	18 (457) CTC	20-5/8 (524)	3/4 (19)	2 (51)	5/8 L x 5/8 W (16 L x 16 W)	Carbon Steel	(2) #10-24 x 3/4in Pan Head Machine Screw (2) #10-24 x 1in Pan Head Machine Screw (2) #10-24 x 1-1/4in Pan Head Machine Screw (2) #10-24 x 1-1/2in Pan Head Machine Screw (2) #10-24 x 1-3/4in Pan Head Machine Screw	N/A
BP54025SS	Appliance Pull	Stainless Steel	18 (457) CTC	20-5/8 (524)	3/4 (19)	2 (51)	5/8 L x 5/8 W (16 L x 16 W)	Stainless Steel	(2) #10-24 x 3/4in Pan Head Machine Screw (2) #10-24 x 1in Pan Head Machine Screw (2) #10-24 x 1-1/4in Pan Head Machine Screw (2) #10-24 x 1-1/2in Pan Head Machine Screw (2) #10-24 x 1-3/4in Pan Head Machine Screw	N/A

Mounting hardware included.  
The dimensional information provided here should be verified with the actual product prior to drilling or attempting to install the hardware.  
Please direct any questions you may have on the installation process to Amerock Customer Service (see back cover for contact information).

# PRODUCT INDEX

Product No.	Type	Finish	Product Detail in (mm)	Length in (mm)	Width in (mm)	Projection in (mm)	Base Dimensions in (mm)	Base Material	Mounting Hardware Included	ADA-Friendly
<b>Bar Pulls (Hollow) • p. 72</b>										
BP36800SS	Pull	Stainless Steel	3-3/4 (96) CTC	6-1/16 (154)	1/2 (13)	1-3/8 (35)	3/8 L x 3/8 W (10 L x 10 W)	Stainless Steel	(2) #8-32 x 1in Truss Head Machine Screw (2) #8-32 x 1-1/2in Truss Head Machine Screw	N/A
BP36801SS	Pull	Stainless Steel	5-1/16 (128) CTC	6-7/8 (175)	1/2 (13)	1-3/8 (35)	3/8 L x 3/8 W (10 L x 10 W)	Stainless Steel	(2) #8-32 x 1in Truss Head Machine Screw (2) #8-32 x 1-1/2in Truss Head Machine Screw	N/A
BP36802SS	Pull	Stainless Steel	7-9/16 (192) CTC	10-5/8 (270)	1/2 (13)	1-3/8 (35)	3/8 L x 3/8 W (10 L x 10 W)	Stainless Steel	(2) #8-32 x 1in Truss Head Machine Screw (2) #8-32 x 1-1/2in Truss Head Machine Screw	N/A
BP36803SS	Pull	Stainless Steel	8-13/16 (224) CTC	11-7/8 (302)	1/2 (13)	1-3/8 (35)	3/8 L x 3/8 W (10 L x 10 W)	Stainless Steel	(2) #8-32 x 1in Truss Head Machine Screw (2) #8-32 x 1-1/2in Truss Head Machine Screw	N/A
BP36804SS	Pull	Stainless Steel	10-1/16 (256) CTC	13-1/8 (333)	1/2 (13)	1-3/8 (35)	3/8 L x 3/8 W (10 L x 10 W)	Stainless Steel	(2) #8-32 x 1in Truss Head Machine Screw (2) #8-32 x 1-1/2in Truss Head Machine Screw	N/A
BP36805SS	Pull	Stainless Steel	11-5/16 (288) CTC	14-7/16 (367)	1/2 (13)	1-3/8 (35)	3/8 L x 3/8 W (10 L x 10 W)	Stainless Steel	(2) #8-32 x 1in Truss Head Machine Screw (2) #8-32 x 1-1/2in Truss Head Machine Screw	N/A
<b>Cyprus • p. 74</b>										
BP26201BBR	Pull	Black Bronze	3 (76) CTC	5-1/4 (133)	3/8 (10)	1-1/16 (27)	3/8 L x 1/4 W (10 L x 6 W)	Zinc	(2) #8-32 x 1in Truss Head Machine Screw (2) #8-32 x 1-1/2in Truss Head Machine Screw	N/A
BP26201BBZ	Pull	Golden Champagne	3 (76) CTC	5-1/4 (133)	3/8 (10)	1-1/16 (27)	3/8 L x 1/4 W (10 L x 6 W)	Zinc	(2) #8-32 x 1in Truss Head Machine Screw (2) #8-32 x 1-1/2in Truss Head Machine Screw	N/A
BP26201G10	Pull	Satin Nickel	3 (76) CTC	5-1/4 (133)	3/8 (10)	1-1/16 (27)	3/8 L x 1/4 W (10 L x 6 W)	Zinc	(2) #8-32 x 1in Truss Head Machine Screw (2) #8-32 x 1-1/2in Truss Head Machine Screw	N/A
BP26201ORB	Pull	Oil-Rubbed Bronze	3 (76) CTC	5-1/4 (133)	3/8 (10)	1-1/16 (27)	3/8 L x 1/4 W (10 L x 6 W)	Zinc	(2) #8-32 x 1in Truss Head Machine Screw (2) #8-32 x 1-1/2in Truss Head Machine Screw	N/A
BP26201PN	Pull	Polished Nickel	3 (76) CTC	5-1/4 (133)	3/8 (10)	1-1/16 (27)	3/8 L x 1/4 W (10 L x 6 W)	Zinc	(2) #8-32 x 1in Truss Head Machine Screw (2) #8-32 x 1-1/2in Truss Head Machine Screw	N/A
BP26203BBR	Pull	Black Bronze	3-3/4 (96) CTC	6-9/16 (167)	1/2 (13)	1-1/8 (29)	3/8 L x 5/16 W (10 L x 8 W)	Zinc	(2) #8-32 x 1in Truss Head Machine Screw (2) #8-32 x 1-1/2in Truss Head Machine Screw	N/A
BP26203BBZ	Pull	Golden Champagne	3-3/4 (96) CTC	6-9/16 (167)	1/2 (13)	1-1/8 (29)	3/8 L x 5/16 W (10 L x 8 W)	Zinc	(2) #8-32 x 1in Truss Head Machine Screw (2) #8-32 x 1-1/2in Truss Head Machine Screw	N/A
BP26203G10	Pull	Satin Nickel	3-3/4 (96) CTC	6-9/16 (167)	1/2 (13)	1-1/8 (29)	3/8 L x 5/16 W (10 L x 8 W)	Zinc	(2) #8-32 x 1in Truss Head Machine Screw (2) #8-32 x 1-1/2in Truss Head Machine Screw	N/A
BP26203ORB	Pull	Oil-Rubbed Bronze	3-3/4 (96) CTC	6-9/16 (167)	1/2 (13)	1-1/8 (29)	3/8 L x 5/16 W (10 L x 8 W)	Zinc	(2) #8-32 x 1in Truss Head Machine Screw (2) #8-32 x 1-1/2in Truss Head Machine Screw	N/A
BP26203PN	Pull	Polished Nickel	3-3/4 (96) CTC	6-9/16 (167)	1/2 (13)	1-1/8 (29)	3/8 L x 5/16 W (10 L x 8 W)	Zinc	(2) #8-32 x 1in Truss Head Machine Screw (2) #8-32 x 1-1/2in Truss Head Machine Screw	N/A
BP26204BBR	Pull	Black Bronze	6-5/16 (160) CTC	9-1/16 (230)	1/2 (13)	1-1/4 (32)	7/16 L x 5/16 W (11 L x 8 W)	Zinc	(2) #8-32 x 1in Truss Head Machine Screw (2) #8-32 x 1-1/2in Truss Head Machine Screw	N/A
BP26204BBZ	Pull	Golden Champagne	6-5/16 (160) CTC	9-1/16 (230)	1/2 (13)	1-1/4 (32)	7/16 L x 5/16 W (11 L x 8 W)	Zinc	(2) #8-32 x 1in Truss Head Machine Screw (2) #8-32 x 1-1/2in Truss Head Machine Screw	N/A
BP26204G10	Pull	Satin Nickel	6-5/16 (160) CTC	9-1/16 (230)	1/2 (13)	1-1/4 (32)	7/16 L x 5/16 W (11 L x 8 W)	Zinc	(2) #8-32 x 1in Truss Head Machine Screw (2) #8-32 x 1-1/2in Truss Head Machine Screw	N/A
BP26204ORB	Pull	Oil-Rubbed Bronze	6-5/16 (160) CTC	9-1/16 (230)	1/2 (13)	1-1/4 (32)	7/16 L x 5/16 W (11 L x 8 W)	Zinc	(2) #8-32 x 1in Truss Head Machine Screw (2) #8-32 x 1-1/2in Truss Head Machine Screw	N/A
BP26204PN	Pull	Polished Nickel	6-5/16 (160) CTC	9-1/16 (230)	1/2 (13)	1-1/4 (32)	7/16 L x 5/16 W (11 L x 8 W)	Zinc	(2) #8-32 x 1in Truss Head Machine Screw (2) #8-32 x 1-1/2in Truss Head Machine Screw	N/A
BP26205BBR	Appliance Pull	Black Bronze	8 (203) CTC	12 (305)	7/8 (22)	1-5/8 (41)	9/16 L x 7/16 W (14 L x 11 W)	Zinc	(2) #10-24 x 3/4in Pan Head Machine Screw (2) #10-24 x 1in Pan Head Machine Screw (2) #10-24 x 1-1/4in Pan Head Machine Screw (2) #10-24 x 1-1/2in Pan Head Machine Screw (2) #10-24 x 1-3/4in Pan Head Machine Screw	N/A

Mounting hardware included.  
The dimensional information provided here should be verified with the actual product prior to drilling or attempting to install the hardware.  
Please direct any questions you may have on the installation process to Amerock Customer Service (see back cover for contact information).

# PRODUCT INDEX

Product No.	Type	Finish	Product Detail in (mm)	Length in (mm)	Width in (mm)	Projection in (mm)	Base Dimensions in (mm)	Base Material	Mounting Hardware Included	ADA-Friendly
<b>Cyprus (continued) • p. 74</b>										
BP26205BBZ	Appliance Pull	Golden Champagne	8 (203) CTC	12 (305)	7/8 (22)	1-5/8 (41)	9/16 L x 7/16 W (14 L x 11 W)	Zinc	(2) #10-24 x 3/4in Pan Head Machine Screw (2) #10-24 x 1in Pan Head Machine Screw (2) #10-24 x 1-1/4in Pan Head Machine Screw (2) #10-24 x 1-1/2in Pan Head Machine Screw (2) #10-24 x 1-3/4in Pan Head Machine Screw	N/A
BP26205G10	Appliance Pull	Satin Nickel	8 (203) CTC	12 (305)	7/8 (22)	1-5/8 (41)	9/16 L x 7/16 W (14 L x 11 W)	Zinc	(2) #10-24 x 3/4in Pan Head Machine Screw (2) #10-24 x 1in Pan Head Machine Screw (2) #10-24 x 1-1/4in Pan Head Machine Screw (2) #10-24 x 1-1/2in Pan Head Machine Screw (2) #10-24 x 1-3/4in Pan Head Machine Screw	N/A
BP26205ORB	Appliance Pull	Oil-Rubbed Bronze	8 (203) CTC	12 (305)	7/8 (22)	1-5/8 (41)	9/16 L x 7/16 W (14 L x 11 W)	Zinc	(2) #10-24 x 3/4in Pan Head Machine Screw (2) #10-24 x 1in Pan Head Machine Screw (2) #10-24 x 1-1/4in Pan Head Machine Screw (2) #10-24 x 1-1/2in Pan Head Machine Screw (2) #10-24 x 1-3/4in Pan Head Machine Screw	N/A
BP26205PN	Appliance Pull	Polished Nickel	8 (203) CTC	12 (305)	7/8 (22)	1-5/8 (41)	9/16 L x 7/16 W (14 L x 11 W)	Zinc	(2) #10-24 x 3/4in Pan Head Machine Screw (2) #10-24 x 1in Pan Head Machine Screw (2) #10-24 x 1-1/4in Pan Head Machine Screw (2) #10-24 x 1-1/2in Pan Head Machine Screw (2) #10-24 x 1-3/4in Pan Head Machine Screw	N/A
BP26206BBR	Appliance Pull	Black Bronze	12 (305) CTC	16 (406)	7/8 (22)	1-11/16 (43)	9/16 L x 7/16 W (14 L x 11 W)	Zinc	(2) #10-24 x 3/4in Pan Head Machine Screw (2) #10-24 x 1in Pan Head Machine Screw (2) #10-24 x 1-1/4in Pan Head Machine Screw (2) #10-24 x 1-1/2in Pan Head Machine Screw (2) #10-24 x 1-3/4in Pan Head Machine Screw	N/A
BP26206BBZ	Appliance Pull	Golden Champagne	12 (305) CTC	16 (406)	7/8 (22)	1-11/16 (43)	9/16 L x 7/16 W (14 L x 11 W)	Zinc	(2) #10-24 x 3/4in Pan Head Machine Screw (2) #10-24 x 1in Pan Head Machine Screw (2) #10-24 x 1-1/4in Pan Head Machine Screw (2) #10-24 x 1-1/2in Pan Head Machine Screw (2) #10-24 x 1-3/4in Pan Head Machine Screw	N/A
BP26206G10	Appliance Pull	Satin Nickel	12 (305) CTC	16 (406)	7/8 (22)	1-11/16 (43)	9/16 L x 7/16 W (14 L x 11 W)	Zinc	(2) #10-24 x 3/4in Pan Head Machine Screw (2) #10-24 x 1in Pan Head Machine Screw (2) #10-24 x 1-1/4in Pan Head Machine Screw (2) #10-24 x 1-1/2in Pan Head Machine Screw (2) #10-24 x 1-3/4in Pan Head Machine Screw	N/A
BP26206ORB	Appliance Pull	Oil-Rubbed Bronze	12 (305) CTC	16 (406)	7/8 (22)	1-11/16 (43)	9/16 L x 7/16 W (14 L x 11 W)	Zinc	(2) #10-24 x 3/4in Pan Head Machine Screw (2) #10-24 x 1in Pan Head Machine Screw (2) #10-24 x 1-1/4in Pan Head Machine Screw (2) #10-24 x 1-1/2in Pan Head Machine Screw (2) #10-24 x 1-3/4in Pan Head Machine Screw	N/A
BP26206PN	Appliance Pull	Polished Nickel	12 (305) CTC	16 (406)	7/8 (22)	1-11/16 (43)	9/16 L x 7/16 W (14 L x 11 W)	Zinc	(2) #10-24 x 3/4in Pan Head Machine Screw (2) #10-24 x 1in Pan Head Machine Screw (2) #10-24 x 1-1/4in Pan Head Machine Screw (2) #10-24 x 1-1/2in Pan Head Machine Screw (2) #10-24 x 1-3/4in Pan Head Machine Screw	N/A
BP26207BBR	Appliance Pull	Black Bronze	18 (457) CTC	22 (559)	7/8 (22)	1-11/16 (43)	9/16 L x 7/16 W (14 L x 11 W)	Zinc	(2) #10-24 x 3/4in Pan Head Machine Screw (2) #10-24 x 1in Pan Head Machine Screw (2) #10-24 x 1-1/4in Pan Head Machine Screw (2) #10-24 x 1-1/2in Pan Head Machine Screw (2) #10-24 x 1-3/4in Pan Head Machine Screw	N/A
BP26207BBZ	Appliance Pull	Golden Champagne	18 (457) CTC	22 (559)	7/8 (22)	1-11/16 (43)	9/16 L x 7/16 W (14 L x 11 W)	Zinc	(2) #10-24 x 3/4in Pan Head Machine Screw (2) #10-24 x 1in Pan Head Machine Screw (2) #10-24 x 1-1/4in Pan Head Machine Screw (2) #10-24 x 1-1/2in Pan Head Machine Screw (2) #10-24 x 1-3/4in Pan Head Machine Screw	N/A

Mounting hardware included.

The dimensional information provided here should be verified with the actual product prior to drilling or attempting to install the hardware. Please direct any questions you may have on the installation process to Amerock Customer Service (see back cover for contact information).

# PRODUCT INDEX

Product No.	Type	Finish	Product Detail in (mm)	Length in (mm)	Width in (mm)	Projection in (mm)	Base Dimensions in (mm)	Base Material	Mounting Hardware Included	ADA-Friendly
<b>Cyprus (continued) • p. 74</b>										
BP26207G10	Appliance Pull	Satin Nickel	18 (457) CTC	22 (559)	7/8 (22)	1-11/16 (43)	9/16 L x 7/16 W (14 L x 11 W)	Zinc	(2) #10-24 x 3/4in Pan Head Machine Screw (2) #10-24 x 1in Pan Head Machine Screw (2) #10-24 x 1-1/4in Pan Head Machine Screw (2) #10-24 x 1-1/2in Pan Head Machine Screw (2) #10-24 x 1-3/4in Pan Head Machine Screw	N/A
BP26207ORB	Appliance Pull	Oil-Rubbed Bronze	18 (457) CTC	22 (559)	7/8 (22)	1-11/16 (43)	9/16 L x 7/16 W (14 L x 11 W)	Zinc	(2) #10-24 x 3/4in Pan Head Machine Screw (2) #10-24 x 1in Pan Head Machine Screw (2) #10-24 x 1-1/4in Pan Head Machine Screw (2) #10-24 x 1-1/2in Pan Head Machine Screw (2) #10-24 x 1-3/4in Pan Head Machine Screw	N/A
BP26207PN	Appliance Pull	Polished Nickel	18 (457) CTC	22 (559)	7/8 (22)	1-11/16 (43)	9/16 L x 7/16 W (14 L x 11 W)	Zinc	(2) #10-24 x 3/4in Pan Head Machine Screw (2) #10-24 x 1in Pan Head Machine Screw (2) #10-24 x 1-1/4in Pan Head Machine Screw (2) #10-24 x 1-1/2in Pan Head Machine Screw (2) #10-24 x 1-3/4in Pan Head Machine Screw	N/A
BP9362BBR	Pull	Black Bronze	5-1/16 (128) CTC	7-13/16 (198)	1/2 (13)	1-3/16 (30)	7/16 L x 5/16 W (11 L x 8 W)	Zinc	(2) #8-32 x 1in Truss Head Machine Screw (2) #8-32 x 1-1/2in Truss Head Machine Screw	N/A
BP9362BBZ	Pull	Golden Champagne	5-1/16 (128) CTC	7-13/16 (198)	1/2 (13)	1-3/16 (30)	7/16 L x 5/16 W (11 L x 8 W)	Zinc	(2) #8-32 x 1in Truss Head Machine Screw (2) #8-32 x 1-1/2in Truss Head Machine Screw	N/A
BP9362G10	Pull	Satin Nickel	5-1/16 (128) CTC	7-13/16 (198)	1/2 (13)	1-3/16 (30)	7/16 L x 5/16 W (11 L x 8 W)	Zinc	(2) #8-32 x 1in Truss Head Machine Screw (2) #8-32 x 1-1/2in Truss Head Machine Screw	N/A
BP9362ORB	Pull	Oil-Rubbed Bronze	5-1/16 (128) CTC	7-13/16 (198)	1/2 (13)	1-3/16 (30)	7/16 L x 5/16 W (11 L x 8 W)	Zinc	(2) #8-32 x 1in Truss Head Machine Screw (2) #8-32 x 1-1/2in Truss Head Machine Screw	N/A
BP9362PN	Pull	Polished Nickel	5-1/16 (128) CTC	7-13/16 (198)	1/2 (13)	1-3/16 (30)	7/16 L x 5/16 W (11 L x 8 W)	Zinc	(2) #8-32 x 1in Truss Head Machine Screw (2) #8-32 x 1-1/2in Truss Head Machine Screw	N/A
<b>Mulholland • p. 78</b>										
BH3602026	Robe Hook	Chrome	Single	4-1/4 (108)	1-13/16 (48)	3-5/8 (92)	1-13/16 L x 1-13/16 W (46 L x 46 W)	Zinc	(2) #8 x 1-1/4 in. Sheet Metal Screw (1) Mounting Bracket	N/A
BH36020BBZ	Robe Hook	Golden Champagne	Single	4-1/4 (108)	1-13/16 (48)	3-5/8 (92)	1-13/16 L x 1-13/16 W (46 L x 46 W)	Zinc	(2) #8 x 1-1/4 in. Sheet Metal Screw (1) Mounting Bracket	N/A
BH36020CZ	Robe Hook	Champagne Bronze	Single	4-1/4 (108)	1-13/16 (48)	3-5/8 (92)	1-13/16 L x 1-13/16 W (46 L x 46 W)	Zinc	(2) #8 x 1-1/4 in. Sheet Metal Screw (1) Mounting Bracket	N/A
BH36020G10	Robe Hook	Brushed Nickel	Single	4-1/4 (108)	1-13/16 (48)	3-5/8 (92)	1-13/16 L x 1-13/16 W (46 L x 46 W)	Zinc	(2) #8 x 1-1/4 in. Sheet Metal Screw (1) Mounting Bracket	N/A
BH36020MB	Robe Hook	Matte Black	Single	4-1/4 (108)	1-13/16 (48)	3-5/8 (92)	1-13/16 L x 1-13/16 W (46 L x 46 W)	Zinc	(2) #8 x 1-1/4 in. Sheet Metal Screw (1) Mounting Bracket	N/A
BH36020ORB	Robe Hook	Oil-Rubbed Bronze	Single	4-1/4 (108)	1-13/16 (48)	3-5/8 (92)	1-13/16 L x 1-13/16 W (46 L x 46 W)	Zinc	(2) #8 x 1-1/4 in. Sheet Metal Screw (1) Mounting Bracket	N/A
BP5302926	Knob	Polished Chrome	1-1/4 (32) LGTH	1-1/4 (32)	13/16 (21)	1-3/16 (30)	3/4 L x 3/4 W (19 L x 19 W)	Zinc	(1) #8-32 x 1in Truss Head Machine Screw (1) #8-32 x 1-1/2in Truss Head Machine Screw	N/A
BP53029BBR	Knob	Black Bronze	1-1/4 (32) LGTH	1-1/4 (32)	13/16 (21)	1-3/16 (30)	3/4 L x 3/4 W (19 L x 19 W)	Zinc	(1) #8-32 x 1in Truss Head Machine Screw (1) #8-32 x 1-1/2in Truss Head Machine Screw	N/A
BP53029BBZ	Knob	Golden Champagne	1-1/4 (32) LGTH	1-1/4 (32)	13/16 (21)	1-3/16 (30)	3/4 L x 3/4 W (19 L x 19 W)	Zinc	(1) #8-32 x 1in Truss Head Machine Screw (1) #8-32 x 1-1/2in Truss Head Machine Screw	N/A
BP53029CZ	Knob	Champagne Bronze	1-1/4 (32) LGTH	1-1/4 (32)	13/16 (21)	1-3/16 (30)	3/4 L x 3/4 W (19 L x 19 W)	Zinc	(1) #8-32 x 1in Truss Head Machine Screw (1) #8-32 x 1-1/2in Truss Head Machine Screw	N/A
BP53029G10	Knob	Satin Nickel	1-1/4 (32) LGTH	1-1/4 (32)	13/16 (21)	1-3/16 (30)	3/4 L x 3/4 W (19 L x 19 W)	Zinc	(1) #8-32 x 1in Truss Head Machine Screw (1) #8-32 x 1-1/2in Truss Head Machine Screw	N/A
BP53029GB	Knob	Gilded Bronze	1-1/4 (32) LGTH	1-1/4 (32)	13/16 (21)	1-3/16 (30)	3/4 L x 3/4 W (19 L x 19 W)	Zinc	(1) #8-32 x 1in Truss Head Machine Screw (1) #8-32 x 1-1/2in Truss Head Machine Screw	N/A

Mounting hardware included.  
The dimensional information provided here should be verified with the actual product prior to drilling or attempting to install the hardware.  
Please direct any questions you may have on the installation process to Amerock Customer Service (see back cover for contact information).

# PRODUCT INDEX

Product No.	Type	Finish	Product Detail in (mm)	Length in (mm)	Width in (mm)	Projection in (mm)	Base Dimensions in (mm)	Base Material	Mounting Hardware Included	ADA-Friendly
<b>Mulholland (continued) • p. 78</b>										
BP53029GM	Knob	Gunmetal	1-1/4 (32) LGTH	1-1/4 (32)	13/16 (21)	1-3/16 (30)	3/4 L x 3/4 W (19 L x 19 W)	Zinc	(1) #8-32 x 1in Truss Head Machine Screw (1) #8-32 x 1-1/2in Truss Head Machine Screw	N/A
BP53029ORB	Knob	Oil-Rubbed Bronze	1-1/4 (32) LGTH	1-1/4 (32)	13/16 (21)	1-3/16 (30)	3/4 L x 3/4 W (19 L x 19 W)	Zinc	(1) #8-32 x 1in Truss Head Machine Screw (1) #8-32 x 1-1/2in Truss Head Machine Screw	N/A
BP53029PN	Knob	Polished Nickel	1-1/4 (32) LGTH	1-1/4 (32)	13/16 (21)	1-3/16 (30)	3/4 L x 3/4 W (19 L x 19 W)	Zinc	(1) #8-32 x 1in Truss Head Machine Screw (1) #8-32 x 1-1/2in Truss Head Machine Screw	N/A
BP5303026	Pull	Polished Chrome	3 (76) CTC	3-3/4 (96)	11/16 (17)	1-1/16 (27)	11/16 L x 11/16 W (17 L x 17 W)	Zinc	(2) #8-32 x 1in Truss Head Machine Screw (2) #8-32 x 1-1/2in Truss Head Machine Screw	N/A
BP53030BBR	Pull	Black Bronze	3 (76) CTC	3-3/4 (96)	11/16 (17)	1-1/16 (27)	11/16 L x 11/16 W (17 L x 17 W)	Zinc	(2) #8-32 x 1in Truss Head Machine Screw (2) #8-32 x 1-1/2in Truss Head Machine Screw	N/A
BP53030BBZ	Pull	Golden Champagne	3 (76) CTC	3-3/4 (96)	11/16 (17)	1-1/16 (27)	11/16 L x 11/16 W (17 L x 17 W)	Zinc	(2) #8-32 x 1in Truss Head Machine Screw (2) #8-32 x 1-1/2in Truss Head Machine Screw	N/A
BP53030CZ	Pull	Champagne Bronze	3 (76) CTC	3-3/4 (96)	11/16 (17)	1-1/16 (27)	11/16 L x 11/16 W (17 L x 17 W)	Zinc	(2) #8-32 x 1in Truss Head Machine Screw (2) #8-32 x 1-1/2in Truss Head Machine Screw	N/A
BP53030G10	Pull	Satin Nickel	3 (76) CTC	3-3/4 (96)	11/16 (17)	1-1/16 (27)	11/16 L x 11/16 W (17 L x 17 W)	Zinc	(2) #8-32 x 1in Truss Head Machine Screw (2) #8-32 x 1-1/2in Truss Head Machine Screw	N/A
BP53030GB	Pull	Gilded Bronze	3 (76) CTC	3-3/4 (96)	11/16 (17)	1-1/16 (27)	11/16 L x 11/16 W (17 L x 17 W)	Zinc	(2) #8-32 x 1in Truss Head Machine Screw (2) #8-32 x 1-1/2in Truss Head Machine Screw	N/A
BP53030GM	Pull	Gunmetal	3 (76) CTC	3-3/4 (96)	11/16 (17)	1-1/16 (27)	11/16 L x 11/16 W (17 L x 17 W)	Zinc	(2) #8-32 x 1in Truss Head Machine Screw (2) #8-32 x 1-1/2in Truss Head Machine Screw	N/A
BP53030ORB	Pull	Oil-Rubbed Bronze	3 (76) CTC	3-3/4 (96)	11/16 (17)	1-1/16 (27)	11/16 L x 11/16 W (17 L x 17 W)	Zinc	(2) #8-32 x 1in Truss Head Machine Screw (2) #8-32 x 1-1/2in Truss Head Machine Screw	N/A
BP53030PN	Pull	Polished Nickel	3 (76) CTC	3-3/4 (96)	11/16 (17)	1-1/16 (27)	11/16 L x 11/16 W (17 L x 17 W)	Zinc	(2) #8-32 x 1in Truss Head Machine Screw (2) #8-32 x 1-1/2in Truss Head Machine Screw	N/A
BP5303126	Pull	Polished Chrome	3-3/4 (96) CTC	4-9/16 (116)	13/16 (21)	1-1/8 (29)	3/4 L x 3/4 W (19 L x 19 W)	Zinc	(2) #8-32 x 1in Truss Head Machine Screw (2) #8-32 x 1-1/2in Truss Head Machine Screw	✓
BP53031BBR	Pull	Black Bronze	3-3/4 (96) CTC	4-9/16 (116)	13/16 (21)	1-1/8 (29)	3/4 L x 3/4 W (19 L x 19 W)	Zinc	(2) #8-32 x 1in Truss Head Machine Screw (2) #8-32 x 1-1/2in Truss Head Machine Screw	✓
BP53031BBZ	Pull	Golden Champagne	3-3/4 (96) CTC	4-9/16 (116)	13/16 (21)	1-1/8 (29)	3/4 L x 3/4 W (19 L x 19 W)	Zinc	(2) #8-32 x 1in Truss Head Machine Screw (2) #8-32 x 1-1/2in Truss Head Machine Screw	✓
BP53031CZ	Pull	Champagne Bronze	3-3/4 (96) CTC	4-9/16 (116)	13/16 (21)	1-1/8 (29)	3/4 L x 3/4 W (19 L x 19 W)	Zinc	(2) #8-32 x 1in Truss Head Machine Screw (2) #8-32 x 1-1/2in Truss Head Machine Screw	✓
BP53031G10	Pull	Satin Nickel	3-3/4 (96) CTC	4-9/16 (116)	13/16 (21)	1-1/8 (29)	3/4 L x 3/4 W (19 L x 19 W)	Zinc	(2) #8-32 x 1in Truss Head Machine Screw (2) #8-32 x 1-1/2in Truss Head Machine Screw	✓
BP53031GB	Pull	Gilded Bronze	3-3/4 (96) CTC	4-9/16 (116)	13/16 (21)	1-1/8 (29)	3/4 L x 3/4 W (19 L x 19 W)	Zinc	(2) #8-32 x 1in Truss Head Machine Screw (2) #8-32 x 1-1/2in Truss Head Machine Screw	✓
BP53031GM	Pull	Gunmetal	3-3/4 (96) CTC	4-9/16 (116)	13/16 (21)	1-1/8 (29)	3/4 L x 3/4 W (19 L x 19 W)	Zinc	(2) #8-32 x 1in Truss Head Machine Screw (2) #8-32 x 1-1/2in Truss Head Machine Screw	✓
BP53031ORB	Pull	Oil-Rubbed Bronze	3-3/4 (96) CTC	4-9/16 (116)	13/16 (21)	1-1/8 (29)	3/4 L x 3/4 W (19 L x 19 W)	Zinc	(2) #8-32 x 1in Truss Head Machine Screw (2) #8-32 x 1-1/2in Truss Head Machine Screw	✓
BP53031PN	Pull	Polished Nickel	3-3/4 (96) CTC	4-9/16 (116)	13/16 (21)	1-1/8 (29)	3/4 L x 3/4 W (19 L x 19 W)	Zinc	(2) #8-32 x 1in Truss Head Machine Screw (2) #8-32 x 1-1/2in Truss Head Machine Screw	✓
BP5352926	Pull	Polished Chrome	5-1/16 (128) CTC	5-7/8 (149)	7/8 (22)	1-1/4 (32)	13/16 L x 13/16 W (21 L x 21 W)	Zinc	(2) #8-32 x 1in Truss Head Machine Screw (2) #8-32 x 1-1/2in Truss Head Machine Screw	✓
BP53529BBR	Pull	Black Bronze	5-1/16 (128) CTC	5-7/8 (149)	7/8 (22)	1-1/4 (32)	13/16 L x 13/16 W (21 L x 21 W)	Zinc	(2) #8-32 x 1in Truss Head Machine Screw (2) #8-32 x 1-1/2in Truss Head Machine Screw	✓
BP53529BBZ	Pull	Golden Champagne	5-1/16 (128) CTC	5-7/8 (149)	7/8 (22)	1-1/4 (32)	13/16 L x 13/16 W (21 L x 21 W)	Zinc	(2) #8-32 x 1in Truss Head Machine Screw (2) #8-32 x 1-1/2in Truss Head Machine Screw	✓
BP53529CZ	Pull	Champagne Bronze	5-1/16 (128) CTC	5-7/8 (149)	7/8 (22)	1-1/4 (32)	13/16 L x 13/16 W (21 L x 21 W)	Zinc	(2) #8-32 x 1in Truss Head Machine Screw (2) #8-32 x 1-1/2in Truss Head Machine Screw	✓

Mounting hardware included.  
The dimensional information provided here should be verified with the actual product prior to drilling or attempting to install the hardware.  
Please direct any questions you may have on the installation process to Amerock Customer Service (see back cover for contact information).

# PRODUCT INDEX

Product No.	Type	Finish	Product Detail in (mm)	Length in (mm)	Width in (mm)	Projection in (mm)	Base Dimensions in (mm)	Base Material	Mounting Hardware Included	ADA-Friendly
Mulholland (continued) • p. 78										
BP53529G10	Pull	Satin Nickel	5-1/16 (128) CTC	5-7/8 (149)	7/8 (22)	1-1/4 (32)	13/16 L x 13/16 W (21 L x 21 W)	Zinc	(2) #8-32 x 1in Truss Head Machine Screw (2) #8-32 x 1-1/2in Truss Head Machine Screw	✓
BP53529GB	Pull	Gilded Bronze	5-1/16 (128) CTC	5-7/8 (149)	7/8 (22)	1-1/4 (32)	13/16 L x 13/16 W (21 L x 21 W)	Zinc	(2) #8-32 x 1in Truss Head Machine Screw (2) #8-32 x 1-1/2in Truss Head Machine Screw	✓
BP53529GM	Pull	Gunmetal	5-1/16 (128) CTC	5-7/8 (149)	7/8 (22)	1-1/4 (32)	13/16 L x 13/16 W (21 L x 21 W)	Zinc	(2) #8-32 x 1in Truss Head Machine Screw (2) #8-32 x 1-1/2in Truss Head Machine Screw	✓
BP53529ORB	Pull	Oil-Rubbed Bronze	5-1/16 (128) CTC	5-7/8 (149)	7/8 (22)	1-1/4 (32)	13/16 L x 13/16 W (21 L x 21 W)	Zinc	(2) #8-32 x 1in Truss Head Machine Screw (2) #8-32 x 1-1/2in Truss Head Machine Screw	✓
BP53529PN	Pull	Polished Nickel	5-1/16 (128) CTC	5-7/8 (149)	7/8 (22)	1-1/4 (32)	13/16 L x 13/16 W (21 L x 21 W)	Zinc	(2) #8-32 x 1in Truss Head Machine Screw (2) #8-32 x 1-1/2in Truss Head Machine Screw	✓
BP5353026	Pull	Polished Chrome	6-5/16 (160) CTC	7-1/8 (181)	7/8 (22)	1-7/16 (37)	7/8 L x 7/8 W (22 L x 22 W)	Zinc	(2) #8-32 x 1in Truss Head Machine Screw (2) #8-32 x 1-1/2in Truss Head Machine Screw	✓
BP53530BBR	Pull	Black Bronze	6-5/16 (160) CTC	7-1/8 (181)	7/8 (22)	1-7/16 (37)	7/8 L x 7/8 W (22 L x 22 W)	Zinc	(2) #8-32 x 1in Truss Head Machine Screw (2) #8-32 x 1-1/2in Truss Head Machine Screw	✓
BP53530BBZ	Pull	Golden Champagne	6-5/16 (160) CTC	7-1/8 (181)	7/8 (22)	1-7/16 (37)	7/8 L x 7/8 W (22 L x 22 W)	Zinc	(2) #8-32 x 1in Truss Head Machine Screw (2) #8-32 x 1-1/2in Truss Head Machine Screw	✓
BP53530CZ	Pull	Champagne Bronze	6-5/16 (160) CTC	7-1/8 (181)	7/8 (22)	1-7/16 (37)	7/8 L x 7/8 W (22 L x 22 W)	Zinc	(2) #8-32 x 1in Truss Head Machine Screw (2) #8-32 x 1-1/2in Truss Head Machine Screw	✓
BP53530G10	Pull	Satin Nickel	6-5/16 (160) CTC	7-1/8 (181)	7/8 (22)	1-7/16 (37)	7/8 L x 7/8 W (22 L x 22 W)	Zinc	(2) #8-32 x 1in Truss Head Machine Screw (2) #8-32 x 1-1/2in Truss Head Machine Screw	✓
BP53530GB	Pull	Gilded Bronze	6-5/16 (160) CTC	7-1/8 (181)	7/8 (22)	1-7/16 (37)	7/8 L x 7/8 W (22 L x 22 W)	Zinc	(2) #8-32 x 1in Truss Head Machine Screw (2) #8-32 x 1-1/2in Truss Head Machine Screw	✓
BP53530GM	Pull	Gunmetal	6-5/16 (160) CTC	7-1/8 (181)	7/8 (22)	1-7/16 (37)	7/8 L x 7/8 W (22 L x 22 W)	Zinc	(2) #8-32 x 1in Truss Head Machine Screw (2) #8-32 x 1-1/2in Truss Head Machine Screw	✓
BP53530ORB	Pull	Oil-Rubbed Bronze	6-5/16 (160) CTC	7-1/8 (181)	7/8 (22)	1-7/16 (37)	7/8 L x 7/8 W (22 L x 22 W)	Zinc	(2) #8-32 x 1in Truss Head Machine Screw (2) #8-32 x 1-1/2in Truss Head Machine Screw	✓
BP53530PN	Pull	Polished Nickel	6-5/16 (160) CTC	7-1/8 (181)	7/8 (22)	1-7/16 (37)	7/8 L x 7/8 W (22 L x 22 W)	Zinc	(2) #8-32 x 1in Truss Head Machine Screw (2) #8-32 x 1-1/2in Truss Head Machine Screw	✓
BP53531BBR	Appliance Pull	Black Bronze	8 (203) CTC	9-3/16 (233)	1-3/16 (30)	1-13/16 (46)	1-3/16 L x 1-3/16 W (30 L x 30 W)	Zinc	(2) #10-24 x 3/4in Pan Head Machine Screw (2) #10-24 x 1in Pan Head Machine Screw (2) #10-24 x 1-1/4in Pan Head Machine Screw (2) #10-24 x 1-1/2in Pan Head Machine Screw (2) #10-24 x 1-3/4in Pan Head Machine Screw	✓
BP53531BBZ	Appliance Pull	Golden Champagne	8 (203) CTC	9-3/16 (233)	1-3/16 (30)	1-13/16 (46)	1-3/16 L x 1-3/16 W (30 L x 30 W)	Zinc	(2) #10-24 x 3/4in Pan Head Machine Screw (2) #10-24 x 1in Pan Head Machine Screw (2) #10-24 x 1-1/4in Pan Head Machine Screw (2) #10-24 x 1-1/2in Pan Head Machine Screw (2) #10-24 x 1-3/4in Pan Head Machine Screw	✓
BP53531G10	Appliance Pull	Satin Nickel	8 (203) CTC	9-3/16 (233)	1-3/16 (30)	1-13/16 (46)	1-3/16 L x 1-3/16 W (30 L x 30 W)	Zinc	(2) #10-24 x 3/4in Pan Head Machine Screw (2) #10-24 x 1in Pan Head Machine Screw (2) #10-24 x 1-1/4in Pan Head Machine Screw (2) #10-24 x 1-1/2in Pan Head Machine Screw (2) #10-24 x 1-3/4in Pan Head Machine Screw	✓
BP53531GB	Appliance Pull	Gilded Bronze	8 (203) CTC	9-3/16 (233)	1-3/16 (30)	1-13/16 (46)	1-3/16 L x 1-3/16 W (30 L x 30 W)	Zinc	(2) #10-24 x 3/4in Pan Head Machine Screw (2) #10-24 x 1in Pan Head Machine Screw (2) #10-24 x 1-1/4in Pan Head Machine Screw (2) #10-24 x 1-1/2in Pan Head Machine Screw (2) #10-24 x 1-3/4in Pan Head Machine Screw	✓
BP53531ORB	Appliance Pull	Oil-Rubbed Bronze	8 (203) CTC	9-3/16 (233)	1-3/16 (30)	1-13/16 (46)	1-3/16 L x 1-3/16 W (30 L x 30 W)	Zinc	(2) #10-24 x 3/4in Pan Head Machine Screw (2) #10-24 x 1in Pan Head Machine Screw (2) #10-24 x 1-1/4in Pan Head Machine Screw (2) #10-24 x 1-1/2in Pan Head Machine Screw (2) #10-24 x 1-3/4in Pan Head Machine Screw	✓

Mounting hardware included.  
The dimensional information provided here should be verified with the actual product prior to drilling or attempting to install the hardware.  
Please direct any questions you may have on the installation process to Amerock Customer Service (see back cover for contact information).

# PRODUCT INDEX

Product No.	Type	Finish	Product Detail in (mm)	Length in (mm)	Width in (mm)	Projection in (mm)	Base Dimensions in (mm)	Base Material	Mounting Hardware Included	ADA-Friendly
<b>Mulholland (continued) • p. 78</b>										
BP53531PN	Appliance Pull	Polished Nickel	8 (203) CTC	9-3/16 (233)	1-3/16 (30)	1-13/16 (46)	1-3/16 L x 1-3/16 W (30 L x 30 W)	Zinc	(2) #10-24 x 3/4in Pan Head Machine Screw (2) #10-24 x 1in Pan Head Machine Screw (2) #10-24 x 1-1/4in Pan Head Machine Screw (2) #10-24 x 1-1/2in Pan Head Machine Screw (2) #10-24 x 1-3/4in Pan Head Machine Screw	✓
BP53532BBR	Appliance Pull	Black Bronze	12 (305) CTC	13-3/16 (335)	1-1/4 (32)	1-15/16 (49)	1-3/16 L x 1-3/16 W (30 L x 30 W)	Zinc	(2) #10-24 x 3/4in Pan Head Machine Screw (2) #10-24 x 1in Pan Head Machine Screw (2) #10-24 x 1-1/4in Pan Head Machine Screw (2) #10-24 x 1-1/2in Pan Head Machine Screw (2) #10-24 x 1-3/4in Pan Head Machine Screw	✓
BP53532BBZ	Appliance Pull	Golden Champagne	12 (305) CTC	13-3/16 (335)	1-1/4 (32)	1-15/16 (49)	1-3/16 L x 1-3/16 W (30 L x 30 W)	Zinc	(2) #10-24 x 3/4in Pan Head Machine Screw (2) #10-24 x 1in Pan Head Machine Screw (2) #10-24 x 1-1/4in Pan Head Machine Screw (2) #10-24 x 1-1/2in Pan Head Machine Screw (2) #10-24 x 1-3/4in Pan Head Machine Screw	✓
BP53532G10	Appliance Pull	Satin Nickel	12 (305) CTC	13-3/16 (335)	1-1/4 (32)	1-15/16 (49)	1-3/16 L x 1-3/16 W (30 L x 30 W)	Zinc	(2) #10-24 x 3/4in Pan Head Machine Screw (2) #10-24 x 1in Pan Head Machine Screw (2) #10-24 x 1-1/4in Pan Head Machine Screw (2) #10-24 x 1-1/2in Pan Head Machine Screw (2) #10-24 x 1-3/4in Pan Head Machine Screw	✓
BP53532GB	Appliance Pull	Gilded Bronze	12 (305) CTC	13-3/16 (335)	1-1/4 (32)	1-15/16 (49)	1-3/16 L x 1-3/16 W (30 L x 30 W)	Zinc	(2) #10-24 x 3/4in Pan Head Machine Screw (2) #10-24 x 1in Pan Head Machine Screw (2) #10-24 x 1-1/4in Pan Head Machine Screw (2) #10-24 x 1-1/2in Pan Head Machine Screw (2) #10-24 x 1-3/4in Pan Head Machine Screw	✓
BP53532ORB	Appliance Pull	Oil-Rubbed Bronze	12 (305) CTC	13-3/16 (335)	1-1/4 (32)	1-15/16 (49)	1-3/16 L x 1-3/16 W (30 L x 30 W)	Zinc	(2) #10-24 x 3/4in Pan Head Machine Screw (2) #10-24 x 1in Pan Head Machine Screw (2) #10-24 x 1-1/4in Pan Head Machine Screw (2) #10-24 x 1-1/2in Pan Head Machine Screw (2) #10-24 x 1-3/4in Pan Head Machine Screw	✓
BP53532PN	Appliance Pull	Polished Nickel	12 (305) CTC	13-3/16 (335)	1-1/4 (32)	1-15/16 (49)	1-3/16 L x 1-3/16 W (30 L x 30 W)	Zinc	(2) #10-24 x 3/4in Pan Head Machine Screw (2) #10-24 x 1in Pan Head Machine Screw (2) #10-24 x 1-1/4in Pan Head Machine Screw (2) #10-24 x 1-1/2in Pan Head Machine Screw (2) #10-24 x 1-3/4in Pan Head Machine Screw	✓
BP53533BBR	Appliance Pull	Black Bronze	18 (457) CTC	19-1/4 (489)	1-5/16 (33)	2 (51)	1-1/4 L x 1-1/4 W (32 L x 32 W)	Zinc	(2) #10-24 x 3/4in Pan Head Machine Screw (2) #10-24 x 1in Pan Head Machine Screw (2) #10-24 x 1-1/4in Pan Head Machine Screw (2) #10-24 x 1-1/2in Pan Head Machine Screw (2) #10-24 x 1-3/4in Pan Head Machine Screw	✓
BP53533BBZ	Appliance Pull	Golden Champagne	18 (457) CTC	19-1/4 (489)	1-5/16 (33)	2 (51)	1-1/4 L x 1-1/4 W (32 L x 32 W)	Zinc	(2) #10-24 x 3/4in Pan Head Machine Screw (2) #10-24 x 1in Pan Head Machine Screw (2) #10-24 x 1-1/4in Pan Head Machine Screw (2) #10-24 x 1-1/2in Pan Head Machine Screw (2) #10-24 x 1-3/4in Pan Head Machine Screw	✓
BP53533G10	Appliance Pull	Satin Nickel	18 (457) CTC	19-1/4 (489)	1-5/16 (33)	2 (51)	1-1/4 L x 1-1/4 W (32 L x 32 W)	Zinc	(2) #10-24 x 3/4in Pan Head Machine Screw (2) #10-24 x 1in Pan Head Machine Screw (2) #10-24 x 1-1/4in Pan Head Machine Screw (2) #10-24 x 1-1/2in Pan Head Machine Screw (2) #10-24 x 1-3/4in Pan Head Machine Screw	✓
BP53533GB	Appliance Pull	Gilded Bronze	18 (457) CTC	19-1/4 (489)	1-5/16 (33)	2 (51)	1-1/4 L x 1-1/4 W (32 L x 32 W)	Zinc	(2) #10-24 x 3/4in Pan Head Machine Screw (2) #10-24 x 1in Pan Head Machine Screw (2) #10-24 x 1-1/4in Pan Head Machine Screw (2) #10-24 x 1-1/2in Pan Head Machine Screw (2) #10-24 x 1-3/4in Pan Head Machine Screw	✓
BP53533ORB	Appliance Pull	Oil-Rubbed Bronze	18 (457) CTC	19-1/4 (489)	1-5/16 (33)	2 (51)	1-1/4 L x 1-1/4 W (32 L x 32 W)	Zinc	(2) #10-24 x 3/4in Pan Head Machine Screw (2) #10-24 x 1in Pan Head Machine Screw (2) #10-24 x 1-1/4in Pan Head Machine Screw (2) #10-24 x 1-1/2in Pan Head Machine Screw (2) #10-24 x 1-3/4in Pan Head Machine Screw	✓

Mounting hardware included.

The dimensional information provided here should be verified with the actual product prior to drilling or attempting to install the hardware. Please direct any questions you may have on the installation process to Amerock Customer Service (see back cover for contact information).

# PRODUCT INDEX

Product No.	Type	Finish	Product Detail in (mm)	Length in (mm)	Width in (mm)	Projection in (mm)	Base Dimensions in (mm)	Base Material	Mounting Hardware Included	ADA-Friendly
<b>Mulholland (continued) • p. 78</b>										
BP53533PN	Appliance Pull	Polished Nickel	18 (457) CTC	19-1/4 (489)	1-5/16 (33)	2 (51)	1-1/4 L x 1-1/4 W (32 L x 32 W)	Zinc	(2) #10-24 x 3/4in Pan Head Machine Screw (2) #10-24 x 1in Pan Head Machine Screw (2) #10-24 x 1-1/4in Pan Head Machine Screw (2) #10-24 x 1-1/2in Pan Head Machine Screw (2) #10-24 x 1-3/4in Pan Head Machine Screw	✓
BP53534226	Knob	Polished Chrome	1-1/2 (38) LGTH	1-1/2 (38)	13/16 (21)	1-3/16 (30)	3/4 L x 3/4 W (19 L x 19 W)	Zinc	(1) #8-32 x 1in Truss Head Machine Screw (1) #8-32 x 1-1/2in Truss Head Machine Screw	N/A
BP535342BBR	Knob	Black Bronze	1-1/2 (38) LGTH	1-1/2 (38)	13/16 (21)	1-3/16 (30)	3/4 L x 3/4 W (19 L x 19 W)	Zinc	(1) #8-32 x 1in Truss Head Machine Screw (1) #8-32 x 1-1/2in Truss Head Machine Screw	N/A
BP535342BBZ	Knob	Golden Champagne	1-1/2 (38) LGTH	1-1/2 (38)	13/16 (21)	1-3/16 (30)	3/4 L x 3/4 W (19 L x 19 W)	Zinc	(1) #8-32 x 1in Truss Head Machine Screw (1) #8-32 x 1-1/2in Truss Head Machine Screw	N/A
BP535342CZ	Knob	Champagne Bronze	1-1/2 (38) LGTH	1-1/2 (38)	13/16 (21)	1-3/16 (30)	3/4 L x 3/4 W (19 L x 19 W)	Zinc	(1) #8-32 x 1in Truss Head Machine Screw (1) #8-32 x 1-1/2in Truss Head Machine Screw	N/A
BP535342G10	Knob	Satin Nickel	1-1/2 (38) LGTH	1-1/2 (38)	13/16 (21)	1-3/16 (30)	3/4 L x 3/4 W (19 L x 19 W)	Zinc	(1) #8-32 x 1in Truss Head Machine Screw (1) #8-32 x 1-1/2in Truss Head Machine Screw	N/A
BP535342GB	Knob	Gilded Bronze	1-1/2 (38) LGTH	1-1/2 (38)	13/16 (21)	1-3/16 (30)	3/4 L x 3/4 W (19 L x 19 W)	Zinc	(1) #8-32 x 1in Truss Head Machine Screw (1) #8-32 x 1-1/2in Truss Head Machine Screw	N/A
BP535342GM	Knob	Gunmetal	1-1/2 (38) LGTH	1-1/2 (38)	13/16 (21)	1-3/16 (30)	3/4 L x 3/4 W (19 L x 19 W)	Zinc	(1) #8-32 x 1in Truss Head Machine Screw (1) #8-32 x 1-1/2in Truss Head Machine Screw	N/A
BP535342ORB	Knob	Oil-Rubbed Bronze	1-1/2 (38) LGTH	1-1/2 (38)	13/16 (21)	1-3/16 (30)	3/4 L x 3/4 W (19 L x 19 W)	Zinc	(1) #8-32 x 1in Truss Head Machine Screw (1) #8-32 x 1-1/2in Truss Head Machine Screw	N/A
BP535342PN	Knob	Polished Nickel	1-1/2 (38) LGTH	1-1/2 (38)	13/16 (21)	1-3/16 (30)	3/4 L x 3/4 W (19 L x 19 W)	Zinc	(1) #8-32 x 1in Truss Head Machine Screw (1) #8-32 x 1-1/2in Truss Head Machine Screw	N/A
<b>Revitalize • p. 80</b>										
BH3603026	Robe Hook	Chrome	Single	2-1/8 (54)	2-1/8 (54)	2-3/8 (60)	2-1/8 L x 2-1/8 W (54 L x 54 W)	Zinc	(2) #8 x 1-1/4 in. Sheet Metal Screw (1) Mounting Bracket	N/A
BH36030BBZ	Robe Hook	Golden Champagne	Single	2-1/8 (54)	2-1/8 (54)	2-3/8 (60)	2-1/8 L x 2-1/8 W (54 L x 54 W)	Zinc	(2) #8 x 1-1/4 in. Sheet Metal Screw (1) Mounting Bracket	N/A
BH36030CZ	Robe Hook	Champagne Bronze	Single	2-1/8 (54)	2-1/8 (54)	2-3/8 (60)	2-1/8 L x 2-1/8 W (54 L x 54 W)	Zinc	(2) #8 x 1-1/4 in. Sheet Metal Screw (1) Mounting Bracket	N/A
BH36030G10	Robe Hook	Brushed Nickel	Single	2-1/8 (54)	2-1/8 (54)	2-3/8 (60)	2-1/8 L x 2-1/8 W (54 L x 54 W)	Zinc	(2) #8 x 1-1/4 in. Sheet Metal Screw (1) Mounting Bracket	N/A
BH36030MB	Robe Hook	Matte Black	Single	2-1/8 (54)	2-1/8 (54)	2-3/8 (60)	2-1/8 L x 2-1/8 W (54 L x 54 W)	Zinc	(2) #8 x 1-1/4 in. Sheet Metal Screw (1) Mounting Bracket	N/A
BH36030ORB	Robe Hook	Oil-Rubbed Bronze	Single	2-1/8 (54)	2-1/8 (54)	2-3/8 (60)	2-1/8 L x 2-1/8 W (54 L x 54 W)	Zinc	(2) #8 x 1-1/4 in. Sheet Metal Screw (1) Mounting Bracket	N/A
BP5534026	Knob	Polished Chrome	1-1/4 (32) LGTH	1-1/4 (32)	7/8 (22)	1-3/16 (30)	11/16 L x 11/16 W (17 L x 17 W)	Zinc	(1) #8-32 x 1in Truss Head Machine Screw (1) #8-32 x 1-1/2in Truss Head Machine Screw	N/A
BP55340BBR	Knob	Black Bronze	1-1/4 (32) LGTH	1-1/4 (32)	7/8 (22)	1-3/16 (30)	11/16 L x 11/16 W (17 L x 17 W)	Zinc	(1) #8-32 x 1in Truss Head Machine Screw (1) #8-32 x 1-1/2in Truss Head Machine Screw	N/A
BP55340BBZ	Knob	Golden Champagne	1-1/4 (32) LGTH	1-1/4 (32)	7/8 (22)	1-3/16 (30)	11/16 L x 11/16 W (17 L x 17 W)	Zinc	(1) #8-32 x 1in Truss Head Machine Screw (1) #8-32 x 1-1/2in Truss Head Machine Screw	N/A
BP55340CZ	Knob	Champagne Bronze	1-1/4 (32) LGTH	1-1/4 (32)	7/8 (22)	1-3/16 (30)	11/16 L x 11/16 W (17 L x 17 W)	Zinc	(1) #8-32 x 1in Truss Head Machine Screw (1) #8-32 x 1-1/2in Truss Head Machine Screw	N/A
BP55340G10	Knob	Satin Nickel	1-1/4 (32) LGTH	1-1/4 (32)	7/8 (22)	1-3/16 (30)	11/16 L x 11/16 W (17 L x 17 W)	Zinc	(1) #8-32 x 1in Truss Head Machine Screw (1) #8-32 x 1-1/2in Truss Head Machine Screw	N/A
BP55340GB	Knob	Gilded Bronze	1-1/4 (32) LGTH	1-1/4 (32)	7/8 (22)	1-3/16 (30)	11/16 L x 11/16 W (17 L x 17 W)	Zinc	(1) #8-32 x 1in Truss Head Machine Screw (1) #8-32 x 1-1/2in Truss Head Machine Screw	N/A

Mounting hardware included.  
The dimensional information provided here should be verified with the actual product prior to drilling or attempting to install the hardware.  
Please direct any questions you may have on the installation process to Amerock Customer Service (see back cover for contact information).



# PRODUCT INDEX

Product No.	Type	Finish	Product Detail in (mm)	Length in (mm)	Width in (mm)	Projection in (mm)	Base Dimensions in (mm)	Base Material	Mounting Hardware Included	ADA-Friendly
<b>Revitalize (continued) • p. 80</b>										
BP55340GM	Knob	Gunmetal	1-1/4 (32) LGTH	1-1/4 (32)	7/8 (22)	1-3/16 (30)	11/16 L x 11/16 W (17 L x 17 W)	Zinc	(1) #8-32 x 1in Truss Head Machine Screw (1) #8-32 x 1-1/2in Truss Head Machine Screw	N/A
BP55340ORB	Knob	Oil-Rubbed Bronze	1-1/4 (32) LGTH	1-1/4 (32)	7/8 (22)	1-3/16 (30)	11/16 L x 11/16 W (17 L x 17 W)	Zinc	(1) #8-32 x 1in Truss Head Machine Screw (1) #8-32 x 1-1/2in Truss Head Machine Screw	N/A
BP55340PN	Knob	Polished Nickel	1-1/4 (32) LGTH	1-1/4 (32)	7/8 (22)	1-3/16 (30)	11/16 L x 11/16 W (17 L x 17 W)	Zinc	(1) #8-32 x 1in Truss Head Machine Screw (1) #8-32 x 1-1/2in Truss Head Machine Screw	N/A
BP55341ORB	Knob	Oil-Rubbed Bronze	1-1/4 (32) DIA	1-1/4 (32)	N/A	1-1/4 (32)	1-1/16 L x 1-1/16 W (27 L x 27 W)	Zinc	(1) #8-32 x 1in Truss Head Machine Screw (1) #8-32 x 1-1/2in Truss Head Machine Screw	N/A
BP55341PN	Knob	Polished Nickel	1-1/4 (32) DIA	1-1/4 (32)	N/A	1-1/4 (32)	1-1/16 L x 1-1/16 W (27 L x 27 W)	Zinc	(1) #8-32 x 1in Truss Head Machine Screw (1) #8-32 x 1-1/2in Truss Head Machine Screw	N/A
BP5534226	Knob	Polished Chrome	1-1/4 (32) DIA	1-1/4 (32)	N/A	1-1/4 (32)	1-1/16 L x 1-1/16 W (27 L x 27 W)	Zinc	(1) #8-32 x 1in Truss Head Machine Screw (1) #8-32 x 1-1/2in Truss Head Machine Screw	N/A
BP55342BBR	Knob	Black Bronze	1-1/4 (32) DIA	1-1/4 (32)	N/A	1-1/4 (32)	1-1/16 L x 1-1/16 W (27 L x 27 W)	Zinc	(1) #8-32 x 1in Truss Head Machine Screw (1) #8-32 x 1-1/2in Truss Head Machine Screw	N/A
BP55342BBZ	Knob	Golden Champagne	1-1/4 (32) DIA	1-1/4 (32)	N/A	1-1/4 (32)	1-1/16 L x 1-1/16 W (27 L x 27 W)	Zinc	(1) #8-32 x 1in Truss Head Machine Screw (1) #8-32 x 1-1/2in Truss Head Machine Screw	N/A
BP55342CZ	Knob	Champagne Bronze	1-1/4 (32) DIA	1-1/4 (32)	N/A	1-1/4 (32)	1-1/16 L x 1-1/16 W (27 L x 27 W)	Zinc	(1) #8-32 x 1in Truss Head Machine Screw (1) #8-32 x 1-1/2in Truss Head Machine Screw	N/A
BP55342G10	Knob	Satin Nickel	1-1/4 (32) DIA	1-1/4 (32)	N/A	1-1/4 (32)	1-1/16 L x 1-1/16 W (27 L x 27 W)	Zinc	(1) #8-32 x 1in Truss Head Machine Screw (1) #8-32 x 1-1/2in Truss Head Machine Screw	N/A
BP55342GB	Knob	Gilded Bronze	1-1/4 (32) DIA	1-1/4 (32)	N/A	1-1/4 (32)	1-1/16 L x 1-1/16 W (27 L x 27 W)	Zinc	(1) #8-32 x 1in Truss Head Machine Screw (1) #8-32 x 1-1/2in Truss Head Machine Screw	N/A
BP55342GM	Knob	Gunmetal	1-1/4 (32) DIA	1-1/4 (32)	N/A	1-1/4 (32)	1-1/16 L x 1-1/16 W (27 L x 27 W)	Zinc	(1) #8-32 x 1in Truss Head Machine Screw (1) #8-32 x 1-1/2in Truss Head Machine Screw	N/A
BP55342ORB	Knob	Oil-Rubbed Bronze	1-1/4 (32) DIA	1-1/4 (32)	N/A	1-1/4 (32)	1-1/16 L x 1-1/16 W (27 L x 27 W)	Zinc	(1) #8-32 x 1in Truss Head Machine Screw (1) #8-32 x 1-1/2in Truss Head Machine Screw	N/A
BP55342PN	Knob	Polished Nickel	1-1/4 (32) DIA	1-1/4 (32)	N/A	1-1/4 (32)	1-1/16 L x 1-1/16 W (27 L x 27 W)	Zinc	(1) #8-32 x 1in Truss Head Machine Screw (1) #8-32 x 1-1/2in Truss Head Machine Screw	N/A
BP55342VB	Knob	Venetian Bronze	1-1/4 (32) DIA	1-1/4 (32)	N/A	1-1/4 (32)	1-1/16 L x 1-1/16 W (27 L x 27 W)	Zinc	(1) #8-32 x 1in Truss Head Machine Screw (1) #8-32 x 1-1/2in Truss Head Machine Screw	N/A
BP5534326	Pull	Polished Chrome	3 (76) CTC	3-11/16 (94)	9/16 (14)	1-3/8 (35)	9/16 L x 9/16 W (14 L x 14 W)	Zinc	(2) #8-32 x 1in Truss Head Machine Screw (2) #8-32 x 1-1/2in Truss Head Machine Screw	N/A
BP55343BBR	Pull	Black Bronze	3 (76) CTC	3-11/16 (94)	9/16 (14)	1-3/8 (35)	9/16 L x 9/16 W (14 L x 14 W)	Zinc	(2) #8-32 x 1in Truss Head Machine Screw (2) #8-32 x 1-1/2in Truss Head Machine Screw	N/A
BP55343BBZ	Pull	Golden Champagne	3 (76) CTC	3-11/16 (94)	9/16 (14)	1-3/8 (35)	9/16 L x 9/16 W (14 L x 14 W)	Zinc	(2) #8-32 x 1in Truss Head Machine Screw (2) #8-32 x 1-1/2in Truss Head Machine Screw	N/A
BP55343CZ	Pull	Champagne Bronze	3 (76) CTC	3-11/16 (94)	9/16 (14)	1-3/8 (35)	9/16 L x 9/16 W (14 L x 14 W)	Zinc	(2) #8-32 x 1in Truss Head Machine Screw (2) #8-32 x 1-1/2in Truss Head Machine Screw	N/A
BP55343G10	Pull	Satin Nickel	3 (76) CTC	3-11/16 (94)	9/16 (14)	1-3/8 (35)	9/16 L x 9/16 W (14 L x 14 W)	Zinc	(2) #8-32 x 1in Truss Head Machine Screw (2) #8-32 x 1-1/2in Truss Head Machine Screw	N/A
BP55343GB	Pull	Gilded Bronze	3 (76) CTC	3-11/16 (94)	9/16 (14)	1-3/8 (35)	9/16 L x 9/16 W (14 L x 14 W)	Zinc	(2) #8-32 x 1in Truss Head Machine Screw (2) #8-32 x 1-1/2in Truss Head Machine Screw	N/A
BP55343GM	Pull	Gunmetal	3 (76) CTC	3-11/16 (94)	9/16 (14)	1-3/8 (35)	9/16 L x 9/16 W (14 L x 14 W)	Zinc	(2) #8-32 x 1in Truss Head Machine Screw (2) #8-32 x 1-1/2in Truss Head Machine Screw	N/A
BP55343ORB	Pull	Oil-Rubbed Bronze	3 (76) CTC	3-11/16 (94)	9/16 (14)	1-3/8 (35)	9/16 L x 9/16 W (14 L x 14 W)	Zinc	(2) #8-32 x 1in Truss Head Machine Screw (2) #8-32 x 1-1/2in Truss Head Machine Screw	N/A
BP55343PN	Pull	Polished Nickel	3 (76) CTC	3-11/16 (94)	9/16 (14)	1-3/8 (35)	9/16 L x 9/16 W (14 L x 14 W)	Zinc	(2) #8-32 x 1in Truss Head Machine Screw (2) #8-32 x 1-1/2in Truss Head Machine Screw	N/A
BP5534426	Pull	Polished Chrome	3-3/4 (96) CTC	4-5/16 (110)	5/8 (16)	1-7/16 (37)	9/16 L x 5/8 W (14 L x 16 W)	Zinc	(2) #8-32 x 1in Truss Head Machine Screw (2) #8-32 x 1-1/2in Truss Head Machine Screw	✓

Mounting hardware included.  
The dimensional information provided here should be verified with the actual product prior to drilling or attempting to install the hardware.  
Please direct any questions you may have on the installation process to Amerock Customer Service (see back cover for contact information).

# PRODUCT INDEX

Product No.	Type	Finish	Product Detail in (mm)	Length in (mm)	Width in (mm)	Projection in (mm)	Base Dimensions in (mm)	Base Material	Mounting Hardware Included	ADA-Friendly
<b>Revitalize (continued) • p. 80</b>										
BP55344BBR	Pull	Black Bronze	3-3/4 (96) CTC	4-5/16 (110)	5/8 (16)	1-7/16 (37)	9/16 L x 5/8 W (14 L x 16 W)	Zinc	(2) #8-32 x 1in Truss Head Machine Screw (2) #8-32 x 1-1/2in Truss Head Machine Screw	✓
BP55344BBZ	Pull	Golden Champagne	3-3/4 (96) CTC	4-5/16 (110)	5/8 (16)	1-7/16 (37)	9/16 L x 5/8 W (14 L x 16 W)	Zinc	(2) #8-32 x 1in Truss Head Machine Screw (2) #8-32 x 1-1/2in Truss Head Machine Screw	✓
BP55344CZ	Pull	Champagne Bronze	3-3/4 (96) CTC	4-5/16 (110)	5/8 (16)	1-7/16 (37)	9/16 L x 5/8 W (14 L x 16 W)	Zinc	(2) #8-32 x 1in Truss Head Machine Screw (2) #8-32 x 1-1/2in Truss Head Machine Screw	✓
BP55344G10	Pull	Satin Nickel	3-3/4 (96) CTC	4-5/16 (110)	5/8 (16)	1-7/16 (37)	9/16 L x 5/8 W (14 L x 16 W)	Zinc	(2) #8-32 x 1in Truss Head Machine Screw (2) #8-32 x 1-1/2in Truss Head Machine Screw	✓
BP55344GB	Pull	Gilded Bronze	3-3/4 (96) CTC	4-5/16 (110)	5/8 (16)	1-7/16 (37)	9/16 L x 5/8 W (14 L x 16 W)	Zinc	(2) #8-32 x 1in Truss Head Machine Screw (2) #8-32 x 1-1/2in Truss Head Machine Screw	✓
BP55344GM	Pull	Gunmetal	3-3/4 (96) CTC	4-5/16 (110)	5/8 (16)	1-7/16 (37)	9/16 L x 5/8 W (14 L x 16 W)	Zinc	(2) #8-32 x 1in Truss Head Machine Screw (2) #8-32 x 1-1/2in Truss Head Machine Screw	✓
BP55344ORB	Pull	Oil-Rubbed Bronze	3-3/4 (96) CTC	4-5/16 (110)	5/8 (16)	1-7/16 (37)	9/16 L x 5/8 W (14 L x 16 W)	Zinc	(2) #8-32 x 1in Truss Head Machine Screw (2) #8-32 x 1-1/2in Truss Head Machine Screw	✓
BP55344PN	Pull	Polished Nickel	3-3/4 (96) CTC	4-5/16 (110)	5/8 (16)	1-7/16 (37)	9/16 L x 5/8 W (14 L x 16 W)	Zinc	(2) #8-32 x 1in Truss Head Machine Screw (2) #8-32 x 1-1/2in Truss Head Machine Screw	✓
BP5534626	Pull	Polished Chrome	5-1/16 (128) CTC	5-5/8 (143)	11/16 (17)	1-9/16 (40)	5/8 L x 11/16 W (16 L x 17 W)	Zinc	(2) #8-32 x 1in Truss Head Machine Screw (2) #8-32 x 1-1/2in Truss Head Machine Screw	✓
BP55346BBR	Pull	Black Bronze	5-1/16 (128) CTC	5-5/8 (143)	11/16 (17)	1-9/16 (40)	5/8 L x 11/16 W (16 L x 17 W)	Zinc	(2) #8-32 x 1in Truss Head Machine Screw (2) #8-32 x 1-1/2in Truss Head Machine Screw	✓
BP55346BBZ	Pull	Golden Champagne	5-1/16 (128) CTC	5-5/8 (143)	11/16 (17)	1-9/16 (40)	5/8 L x 11/16 W (16 L x 17 W)	Zinc	(2) #8-32 x 1in Truss Head Machine Screw (2) #8-32 x 1-1/2in Truss Head Machine Screw	✓
BP55346CZ	Pull	Champagne Bronze	5-1/16 (128) CTC	5-5/8 (143)	11/16 (17)	1-9/16 (40)	5/8 L x 11/16 W (16 L x 17 W)	Zinc	(2) #8-32 x 1in Truss Head Machine Screw (2) #8-32 x 1-1/2in Truss Head Machine Screw	✓
BP55346G10	Pull	Satin Nickel	5-1/16 (128) CTC	5-5/8 (143)	11/16 (17)	1-9/16 (40)	5/8 L x 11/16 W (16 L x 17 W)	Zinc	(2) #8-32 x 1in Truss Head Machine Screw (2) #8-32 x 1-1/2in Truss Head Machine Screw	✓
BP55346GB	Pull	Gilded Bronze	5-1/16 (128) CTC	5-5/8 (143)	11/16 (17)	1-9/16 (40)	5/8 L x 11/16 W (16 L x 17 W)	Zinc	(2) #8-32 x 1in Truss Head Machine Screw (2) #8-32 x 1-1/2in Truss Head Machine Screw	✓
BP55346GM	Pull	Gunmetal	5-1/16 (128) CTC	5-5/8 (143)	11/16 (17)	1-9/16 (40)	5/8 L x 11/16 W (16 L x 17 W)	Zinc	(2) #8-32 x 1in Truss Head Machine Screw (2) #8-32 x 1-1/2in Truss Head Machine Screw	✓
BP55346ORB	Pull	Oil-Rubbed Bronze	5-1/16 (128) CTC	5-5/8 (143)	11/16 (17)	1-9/16 (40)	5/8 L x 11/16 W (16 L x 17 W)	Zinc	(2) #8-32 x 1in Truss Head Machine Screw (2) #8-32 x 1-1/2in Truss Head Machine Screw	✓
BP55346PN	Pull	Polished Nickel	5-1/16 (128) CTC	5-5/8 (143)	11/16 (17)	1-9/16 (40)	5/8 L x 11/16 W (16 L x 17 W)	Zinc	(2) #8-32 x 1in Truss Head Machine Screw (2) #8-32 x 1-1/2in Truss Head Machine Screw	✓
BP5534726	Pull	Polished Chrome	6-5/16 (160) CTC	6-13/16 (173)	3/4 (19)	1-5/8 (41)	11/16 L x 3/4 W (17 L x 19 W)	Zinc	(2) #8-32 x 1in Truss Head Machine Screw (2) #8-32 x 1-1/2in Truss Head Machine Screw	✓
BP55347BBR	Pull	Black Bronze	6-5/16 (160) CTC	6-13/16 (173)	3/4 (19)	1-5/8 (41)	11/16 L x 3/4 W (17 L x 19 W)	Zinc	(2) #8-32 x 1in Truss Head Machine Screw (2) #8-32 x 1-1/2in Truss Head Machine Screw	✓
BP55347BBZ	Pull	Golden Champagne	6-5/16 (160) CTC	6-13/16 (173)	3/4 (19)	1-5/8 (41)	11/16 L x 3/4 W (17 L x 19 W)	Zinc	(2) #8-32 x 1in Truss Head Machine Screw (2) #8-32 x 1-1/2in Truss Head Machine Screw	✓
BP55347CZ	Pull	Champagne Bronze	6-5/16 (160) CTC	6-13/16 (173)	3/4 (19)	1-5/8 (41)	11/16 L x 3/4 W (17 L x 19 W)	Zinc	(2) #8-32 x 1in Truss Head Machine Screw (2) #8-32 x 1-1/2in Truss Head Machine Screw	✓
BP55347G10	Pull	Satin Nickel	6-5/16 (160) CTC	6-13/16 (173)	3/4 (19)	1-5/8 (41)	11/16 L x 3/4 W (17 L x 19 W)	Zinc	(2) #8-32 x 1in Truss Head Machine Screw (2) #8-32 x 1-1/2in Truss Head Machine Screw	✓
BP55347GB	Pull	Gilded Bronze	6-5/16 (160) CTC	6-13/16 (173)	3/4 (19)	1-5/8 (41)	11/16 L x 3/4 W (17 L x 19 W)	Zinc	(2) #8-32 x 1in Truss Head Machine Screw (2) #8-32 x 1-1/2in Truss Head Machine Screw	✓
BP55347GM	Pull	Gunmetal	6-5/16 (160) CTC	6-13/16 (173)	3/4 (19)	1-5/8 (41)	11/16 L x 3/4 W (17 L x 19 W)	Zinc	(2) #8-32 x 1in Truss Head Machine Screw (2) #8-32 x 1-1/2in Truss Head Machine Screw	✓
BP55347ORB	Pull	Oil-Rubbed Bronze	6-5/16 (160) CTC	6-13/16 (173)	3/4 (19)	1-5/8 (41)	11/16 L x 3/4 W (17 L x 19 W)	Zinc	(2) #8-32 x 1in Truss Head Machine Screw (2) #8-32 x 1-1/2in Truss Head Machine Screw	✓

Mounting hardware included.

The dimensional information provided here should be verified with the actual product prior to drilling or attempting to install the hardware. Please direct any questions you may have on the installation process to Amerock Customer Service (see back cover for contact information).

# PRODUCT INDEX

Product No.	Type	Finish	Product Detail in (mm)	Length in (mm)	Width in (mm)	Projection in (mm)	Base Dimensions in (mm)	Base Material	Mounting Hardware Included	ADA-Friendly
<b>Revitalize (continued) • p. 80</b>										
BP55347PN	Pull	Polished Nickel	6-5/16 (160) CTC	6-13/16 (173)	3/4 (19)	1-5/8 (41)	11/16 L x 3/4 W (17 L x 19 W)	Zinc	(2) #8-32 x 1in Truss Head Machine Screw (2) #8-32 x 1-1/2in Truss Head Machine Screw	✓
BP55348BBR	Appliance Pull	Black Bronze	8 (203) CTC	8-13/16 (224)	1 (25)	2-1/8 (54)	15/16 L x 1 W (24 L x 25 W)	Zinc	(2) #10-24 x 3/4in Pan Head Machine Screw (2) #10-24 x 1in Pan Head Machine Screw (2) #10-24 x 1-1/4in Pan Head Machine Screw (2) #10-24 x 1-1/2in Pan Head Machine Screw (2) #10-24 x 1-3/4in Pan Head Machine Screw	✓
BP55348BBZ	Appliance Pull	Golden Champagne	8 (203) CTC	8-13/16 (224)	1 (25)	2-1/8 (54)	15/16 L x 1 W (24 L x 25 W)	Zinc	(2) #10-24 x 3/4in Pan Head Machine Screw (2) #10-24 x 1in Pan Head Machine Screw (2) #10-24 x 1-1/4in Pan Head Machine Screw (2) #10-24 x 1-1/2in Pan Head Machine Screw (2) #10-24 x 1-3/4in Pan Head Machine Screw	✓
BP55348G10	Appliance Pull	Satin Nickel	8 (203) CTC	8-13/16 (224)	1 (25)	2-1/8 (54)	15/16 L x 1 W (24 L x 25 W)	Zinc	(2) #10-24 x 3/4in Pan Head Machine Screw (2) #10-24 x 1in Pan Head Machine Screw (2) #10-24 x 1-1/4in Pan Head Machine Screw (2) #10-24 x 1-1/2in Pan Head Machine Screw (2) #10-24 x 1-3/4in Pan Head Machine Screw	✓
BP55348GB	Appliance Pull	Gilded Bronze	8 (203) CTC	8-13/16 (224)	1 (25)	2-1/8 (54)	15/16 L x 1 W (24 L x 25 W)	Zinc	(2) #10-24 x 3/4in Pan Head Machine Screw (2) #10-24 x 1in Pan Head Machine Screw (2) #10-24 x 1-1/4in Pan Head Machine Screw (2) #10-24 x 1-1/2in Pan Head Machine Screw (2) #10-24 x 1-3/4in Pan Head Machine Screw	✓
BP55348ORB	Appliance Pull	Oil-Rubbed Bronze	8 (203) CTC	8-13/16 (224)	1 (25)	2-1/8 (54)	15/16 L x 1 W (24 L x 25 W)	Zinc	(2) #10-24 x 3/4in Pan Head Machine Screw (2) #10-24 x 1in Pan Head Machine Screw (2) #10-24 x 1-1/4in Pan Head Machine Screw (2) #10-24 x 1-1/2in Pan Head Machine Screw (2) #10-24 x 1-3/4in Pan Head Machine Screw	✓
BP55348PN	Appliance Pull	Polished Nickel	8 (203) CTC	8-13/16 (224)	1 (25)	2-1/8 (54)	15/16 L x 1 W (24 L x 25 W)	Zinc	(2) #10-24 x 3/4in Pan Head Machine Screw (2) #10-24 x 1in Pan Head Machine Screw (2) #10-24 x 1-1/4in Pan Head Machine Screw (2) #10-24 x 1-1/2in Pan Head Machine Screw (2) #10-24 x 1-3/4in Pan Head Machine Screw	✓
BP55349BBR	Appliance Pull	Black Bronze	12 (305) CTC	12-7/8 (327)	1-1/8 (29)	2-1/4 (57)	1-1/16 L x 1-1/8 W (27 L x 29 W)	Zinc	(2) #10-24 x 3/4in Pan Head Machine Screw (2) #10-24 x 1in Pan Head Machine Screw (2) #10-24 x 1-1/4in Pan Head Machine Screw (2) #10-24 x 1-1/2in Pan Head Machine Screw (2) #10-24 x 1-3/4in Pan Head Machine Screw	✓
BP55349BBZ	Appliance Pull	Golden Champagne	12 (305) CTC	12-7/8 (327)	1-1/8 (29)	2-1/4 (57)	1-1/16 L x 1-1/8 W (27 L x 29 W)	Zinc	(2) #10-24 x 3/4in Pan Head Machine Screw (2) #10-24 x 1in Pan Head Machine Screw (2) #10-24 x 1-1/4in Pan Head Machine Screw (2) #10-24 x 1-1/2in Pan Head Machine Screw (2) #10-24 x 1-3/4in Pan Head Machine Screw	✓
BP55349G10	Appliance Pull	Satin Nickel	12 (305) CTC	12-7/8 (327)	1-1/8 (29)	2-1/4 (57)	1-1/16 L x 1-1/8 W (27 L x 29 W)	Zinc	(2) #10-24 x 3/4in Pan Head Machine Screw (2) #10-24 x 1in Pan Head Machine Screw (2) #10-24 x 1-1/4in Pan Head Machine Screw (2) #10-24 x 1-1/2in Pan Head Machine Screw (2) #10-24 x 1-3/4in Pan Head Machine Screw	✓
BP55349GB	Appliance Pull	Gilded Bronze	12 (305) CTC	12-7/8 (327)	1-1/8 (29)	2-1/4 (57)	1-1/16 L x 1-1/8 W (27 L x 29 W)	Zinc	(2) #10-24 x 3/4in Pan Head Machine Screw (2) #10-24 x 1in Pan Head Machine Screw (2) #10-24 x 1-1/4in Pan Head Machine Screw (2) #10-24 x 1-1/2in Pan Head Machine Screw (2) #10-24 x 1-3/4in Pan Head Machine Screw	✓
BP55349ORB	Appliance Pull	Oil-Rubbed Bronze	12 (305) CTC	12-7/8 (327)	1-1/8 (29)	2-1/4 (57)	1-1/16 L x 1-1/8 W (27 L x 29 W)	Zinc	(2) #10-24 x 3/4in Pan Head Machine Screw (2) #10-24 x 1in Pan Head Machine Screw (2) #10-24 x 1-1/4in Pan Head Machine Screw (2) #10-24 x 1-1/2in Pan Head Machine Screw (2) #10-24 x 1-3/4in Pan Head Machine Screw	✓

Mounting hardware included.

The dimensional information provided here should be verified with the actual product prior to drilling or attempting to install the hardware. Please direct any questions you may have on the installation process to Amerock Customer Service (see back cover for contact information).

# PRODUCT INDEX

Product No.	Type	Finish	Product Detail in (mm)	Length in (mm)	Width in (mm)	Projection in (mm)	Base Dimensions in (mm)	Base Material	Mounting Hardware Included	ADA-Friendly
<b>Revitalize (continued) • p. 80</b>										
BP55349PN	Appliance Pull	Polished Nickel	12 (305) CTC	12-7/8 (327)	1-1/8 (29)	2-1/4 (57)	1-1/16 L x 1-1/8 W (27 L x 29 W)	Zinc	(2) #10-24 x 3/4in Pan Head Machine Screw (2) #10-24 x 1in Pan Head Machine Screw (2) #10-24 x 1-1/4in Pan Head Machine Screw (2) #10-24 x 1-1/2in Pan Head Machine Screw (2) #10-24 x 1-3/4in Pan Head Machine Screw	✓
BP55350BBR	Appliance Pull	Black Bronze	18 (457) CTC	18-7/8 (479)	1-3/16 (30)	2-1/4 (57)	1-1/18 L x 1-3/16 W (29 L x 30 W)	Zinc	(2) #10-24 x 3/4in Pan Head Machine Screw (2) #10-24 x 1in Pan Head Machine Screw (2) #10-24 x 1-1/4in Pan Head Machine Screw (2) #10-24 x 1-1/2in Pan Head Machine Screw (2) #10-24 x 1-3/4in Pan Head Machine Screw	✓
BP55350BBZ	Appliance Pull	Golden Champagne	18 (457) CTC	18-7/8 (479)	1-3/16 (30)	2-1/4 (57)	1-1/18 L x 1-3/16 W (29 L x 30 W)	Zinc	(2) #10-24 x 3/4in Pan Head Machine Screw (2) #10-24 x 1in Pan Head Machine Screw (2) #10-24 x 1-1/4in Pan Head Machine Screw (2) #10-24 x 1-1/2in Pan Head Machine Screw (2) #10-24 x 1-3/4in Pan Head Machine Screw	✓
BP55350G10	Appliance Pull	Satin Nickel	18 (457) CTC	18-7/8 (479)	1-3/16 (30)	2-1/4 (57)	1-1/18 L x 1-3/16 W (29 L x 30 W)	Zinc	(2) #10-24 x 3/4in Pan Head Machine Screw (2) #10-24 x 1in Pan Head Machine Screw (2) #10-24 x 1-1/4in Pan Head Machine Screw (2) #10-24 x 1-1/2in Pan Head Machine Screw (2) #10-24 x 1-3/4in Pan Head Machine Screw	✓
BP55350GB	Appliance Pull	Gilded Bronze	18 (457) CTC	18-7/8 (479)	1-3/16 (30)	2-1/4 (57)	1-1/18 L x 1-3/16 W (29 L x 30 W)	Zinc	(2) #10-24 x 3/4in Pan Head Machine Screw (2) #10-24 x 1in Pan Head Machine Screw (2) #10-24 x 1-1/4in Pan Head Machine Screw (2) #10-24 x 1-1/2in Pan Head Machine Screw (2) #10-24 x 1-3/4in Pan Head Machine Screw	✓
BP55350ORB	Appliance Pull	Oil-Rubbed Bronze	18 (457) CTC	18-7/8 (479)	1-3/16 (30)	2-1/4 (57)	1-1/18 L x 1-3/16 W (29 L x 30 W)	Zinc	(2) #10-24 x 3/4in Pan Head Machine Screw (2) #10-24 x 1in Pan Head Machine Screw (2) #10-24 x 1-1/4in Pan Head Machine Screw (2) #10-24 x 1-1/2in Pan Head Machine Screw (2) #10-24 x 1-3/4in Pan Head Machine Screw	✓
BP55350PN	Appliance Pull	Polished Nickel	18 (457) CTC	18-7/8 (479)	1-3/16 (30)	2-1/4 (57)	1-1/18 L x 1-3/16 W (29 L x 30 W)	Zinc	(2) #10-24 x 3/4in Pan Head Machine Screw (2) #10-24 x 1in Pan Head Machine Screw (2) #10-24 x 1-1/4in Pan Head Machine Screw (2) #10-24 x 1-1/2in Pan Head Machine Screw (2) #10-24 x 1-3/4in Pan Head Machine Screw	✓
<b>Ashby • p. 82</b>										
BP36640BBZ	Cup Pull	Golden Champagne	3 & 4 (76 & 102) CTC	5-1/16 (128)	1-3/4 (44)	1-3/8 (35)	5-1/16 L x 1-3/4 W (129 L x 44 W)	Zinc	(2) #8-32 x 1in Truss Head Machine Screw (2) #8-32 x 1-1/2in Truss Head Machine Screw	N/A
BP36640G10	Cup Pull	Satin Nickel	3 & 4 (76 & 102) CTC	5-1/16 (128)	1-3/4 (44)	1-3/8 (35)	5-1/16 L x 1-3/4 W (129 L x 44 W)	Zinc	(2) #8-32 x 1in Truss Head Machine Screw (2) #8-32 x 1-1/2in Truss Head Machine Screw	N/A
BP36640GM	Cup Pull	Gunmetal	3 & 4 (76 & 102) CTC	5-1/16 (128)	1-3/4 (44)	1-3/8 (35)	5-1/16 L x 1-3/4 W (129 L x 44 W)	Zinc	(2) #8-32 x 1in Truss Head Machine Screw (2) #8-32 x 1-1/2in Truss Head Machine Screw	N/A
BP36640ORB	Cup Pull	Oil-Rubbed Bronze	3 & 4 (76 & 102) CTC	5-1/16 (128)	1-3/4 (44)	1-3/8 (35)	5-1/16 L x 1-3/4 W (129 L x 44 W)	Zinc	(2) #8-32 x 1in Truss Head Machine Screw (2) #8-32 x 1-1/2in Truss Head Machine Screw	N/A
BP36640PN	Cup Pull	Polished Nickel	3 & 4 (76 & 102) CTC	5-1/16 (128)	1-3/4 (44)	1-3/8 (35)	5-1/16 L x 1-3/4 W (129 L x 44 W)	Zinc	(2) #8-32 x 1in Truss Head Machine Screw (2) #8-32 x 1-1/2in Truss Head Machine Screw	N/A
BP36640WN	Cup Pull	Weathered Nickel	3 & 4 (76 & 102) CTC	5-1/16 (128)	1-3/4 (44)	1-3/8 (35)	5-1/16 L x 1-3/4 W (129 L x 44 W)	Zinc	(2) #8-32 x 1in Truss Head Machine Screw (2) #8-32 x 1-1/2in Truss Head Machine Screw	N/A

Mounting hardware included.  
The dimensional information provided here should be verified with the actual product prior to drilling or attempting to install the hardware.  
Please direct any questions you may have on the installation process to Amerock Customer Service (see back cover for contact information).

# PRODUCT INDEX

Product No.	Type	Finish	Product Detail in (mm)	Length in (mm)	Width in (mm)	Projection in (mm)	Base Dimensions in (mm)	Base Material	Mounting Hardware Included	ADA-Friendly
<b>Grace Revitalize • p. 84</b>										
BP36628BBR	Knob	Black Bronze	1-3/8 (35) DIA	1-3/8 (35)	N/A	1-3/16 (30)	11/16 L x 11/16 W (17 L x 17 W)	Zinc	(1) #8-32 x 1in Truss Head Machine Screw (1) #8-32 x 1-1/2in Truss Head Machine Screw	N/A
BP36628BBZ	Knob	Golden Champagne	1-3/8 (35) DIA	1-3/8 (35)	N/A	1-3/16 (30)	11/16 L x 11/16 W (17 L x 17 W)	Zinc	(1) #8-32 x 1in Truss Head Machine Screw (1) #8-32 x 1-1/2in Truss Head Machine Screw	N/A
BP36628G10	Knob	Satin Nickel	1-3/8 (35) DIA	1-3/8 (35)	N/A	1-3/16 (30)	11/16 L x 11/16 W (17 L x 17 W)	Zinc	(1) #8-32 x 1in Truss Head Machine Screw (1) #8-32 x 1-1/2in Truss Head Machine Screw	N/A
BP36628ORB	Knob	Oil-Rubbed Bronze	1-3/8 (35) DIA	1-3/8 (35)	N/A	1-3/16 (30)	11/16 L x 11/16 W (17 L x 17 W)	Zinc	(1) #8-32 x 1in Truss Head Machine Screw (1) #8-32 x 1-1/2in Truss Head Machine Screw	N/A
BP36628PN	Knob	Polished Nickel	1-3/8 (35) DIA	1-3/8 (35)	N/A	1-3/16 (30)	11/16 L x 11/16 W (17 L x 17 W)	Zinc	(1) #8-32 x 1in Truss Head Machine Screw (1) #8-32 x 1-1/2in Truss Head Machine Screw	N/A
BP36629BBR	Knob	Black Bronze	1-3/4 (44) DIA	1-3/4 (44)	N/A	1-3/8 (35)	13/16 L x 13/16 W (21 L x 21 W)	Zinc	(1) #8-32 x 1in Truss Head Machine Screw (1) #8-32 x 1-1/2in Truss Head Machine Screw	N/A
BP36629BBZ	Knob	Golden Champagne	1-3/4 (44) DIA	1-3/4 (44)	N/A	1-3/8 (35)	13/16 L x 13/16 W (21 L x 21 W)	Zinc	(1) #8-32 x 1in Truss Head Machine Screw (1) #8-32 x 1-1/2in Truss Head Machine Screw	N/A
BP36629G10	Knob	Satin Nickel	1-3/4 (44) DIA	1-3/4 (44)	N/A	1-3/8 (35)	13/16 L x 13/16 W (21 L x 21 W)	Zinc	(1) #8-32 x 1in Truss Head Machine Screw (1) #8-32 x 1-1/2in Truss Head Machine Screw	N/A
BP36629ORB	Knob	Oil-Rubbed Bronze	1-3/4 (44) DIA	1-3/4 (44)	N/A	1-3/8 (35)	13/16 L x 13/16 W (21 L x 21 W)	Zinc	(1) #8-32 x 1in Truss Head Machine Screw (1) #8-32 x 1-1/2in Truss Head Machine Screw	N/A
BP36629PN	Knob	Polished Nickel	1-3/4 (44) DIA	1-3/4 (44)	N/A	1-3/8 (35)	13/16 L x 13/16 W (21 L x 21 W)	Zinc	(1) #8-32 x 1in Truss Head Machine Screw (1) #8-32 x 1-1/2in Truss Head Machine Screw	N/A
<b>Sea Grass • p. 86</b>										
BP36614BBZ	Knob	Golden Champagne	1-1/2 (38) LGTH	1-1/2 (38)	1 (25)	1-3/16 (30)	7/16 L x 7/16 W (11 L x 11 W)	Zinc	(1) #8-32 x 1in Truss Head Machine Screw (1) #8-32 x 1-1/2in Truss Head Machine Screw	N/A
BP36614G10	Knob	Satin Nickel	1-1/2 (38) LGTH	1-1/2 (38)	1 (25)	1-3/16 (30)	7/16 L x 7/16 W (11 L x 11 W)	Zinc	(1) #8-32 x 1in Truss Head Machine Screw (1) #8-32 x 1-1/2in Truss Head Machine Screw	N/A
BP36614ORB	Knob	Oil-Rubbed Bronze	1-1/2 (38) LGTH	1-1/2 (38)	1 (25)	1-3/16 (30)	7/16 L x 7/16 W (11 L x 11 W)	Zinc	(1) #8-32 x 1in Truss Head Machine Screw (1) #8-32 x 1-1/2in Truss Head Machine Screw	N/A
BP36615BBZ	Cup Pull	Golden Champagne	3 (76) CTC	3-7/8 (98)	1-13/16 (46)	1-3/16 (30)	3-7/8 L x 1-13/16 W (98 L x 46 W)	Zinc	(2) #8-32 x 1in Truss Head Machine Screw (2) #8-32 x 1-1/2in Truss Head Machine Screw	N/A
BP36615G10	Cup Pull	Satin Nickel	3 (76) CTC	3-7/8 (98)	1-13/16 (46)	1-3/16 (30)	3-7/8 L x 1-13/16 W (98 L x 46 W)	Zinc	(2) #8-32 x 1in Truss Head Machine Screw (2) #8-32 x 1-1/2in Truss Head Machine Screw	N/A
BP36615ORB	Cup Pull	Oil-Rubbed Bronze	3 (76) CTC	3-7/8 (98)	1-13/16 (46)	1-3/16 (30)	3-7/8 L x 1-13/16 W (98 L x 46 W)	Zinc	(2) #8-32 x 1in Truss Head Machine Screw (2) #8-32 x 1-1/2in Truss Head Machine Screw	N/A
BP36617BBZ	Knob	Golden Champagne	1-3/4 (44) LGTH	1-3/4 (44)	1-3/16 (30)	1-5/16 (33)	9/16 L x 1/2 W (14 L x 13 W)	Zinc	(1) #8-32 x 1in Truss Head Machine Screw (1) #8-32 x 1-1/2in Truss Head Machine Screw	N/A
BP36617G10	Knob	Satin Nickel	1-3/4 (44) LGTH	1-3/4 (44)	1-3/16 (30)	1-5/16 (33)	9/16 L x 1/2 W (14 L x 13 W)	Zinc	(1) #8-32 x 1in Truss Head Machine Screw (1) #8-32 x 1-1/2in Truss Head Machine Screw	N/A
BP36617ORB	Knob	Oil-Rubbed Bronze	1-3/4 (44) LGTH	1-3/4 (44)	1-3/16 (30)	1-5/16 (33)	9/16 L x 1/2 W (14 L x 13 W)	Zinc	(1) #8-32 x 1in Truss Head Machine Screw (1) #8-32 x 1-1/2in Truss Head Machine Screw	N/A
BP36621BBZ	Pull	Golden Champagne	3-3/4 (96) CTC	5 (127)	1 (25)	1-3/8 (35)	15/16 L x 15/16 W (24 L x 24 W)	Zinc	(2) #8-32 x 1in Truss Head Machine Screw (2) #8-32 x 1-1/2in Truss Head Machine Screw	N/A
BP36621G10	Pull	Satin Nickel	3-3/4 (96) CTC	5 (127)	1 (25)	1-3/8 (35)	15/16 L x 15/16 W (24 L x 24 W)	Zinc	(2) #8-32 x 1in Truss Head Machine Screw (2) #8-32 x 1-1/2in Truss Head Machine Screw	N/A
BP36621ORB	Pull	Oil-Rubbed Bronze	3-3/4 (96) CTC	5 (127)	1 (25)	1-3/8 (35)	15/16 L x 15/16 W (24 L x 24 W)	Zinc	(2) #8-32 x 1in Truss Head Machine Screw (2) #8-32 x 1-1/2in Truss Head Machine Screw	N/A
BP36622BBZ	Pull	Golden Champagne	5-1/16 (128) CTC	6-1/4 (159)	1 (25)	1-3/8 (35)	15/16 L x 15/16 W (24 L x 24 W)	Zinc	(2) #8-32 x 1in Truss Head Machine Screw (2) #8-32 x 1-1/2in Truss Head Machine Screw	N/A

Mounting hardware included.  
The dimensional information provided here should be verified with the actual product prior to drilling or attempting to install the hardware.  
Please direct any questions you may have on the installation process to Amerock Customer Service (see back cover for contact information).

# PRODUCT INDEX

Product No.	Type	Finish	Product Detail in (mm)	Length in (mm)	Width in (mm)	Projection in (mm)	Base Dimensions in (mm)	Base Material	Mounting Hardware Included	ADA-Friendly
<b>Sea Grass (continued) • p. 86</b>										
BP36622G10	Pull	Satin Nickel	5-1/16 (128) CTC	6-1/4 (159)	1 (25)	1-3/8 (35)	15/16 L x 15/16 W (24 L x 24 W)	Zinc	(2) #8-32 x 1in Truss Head Machine Screw (2) #8-32 x 1-1/2in Truss Head Machine Screw	N/A
BP36622ORB	Pull	Oil-Rubbed Bronze	5-1/16 (128) CTC	6-1/4 (159)	1 (25)	1-3/8 (35)	15/16 L x 15/16 W (24 L x 24 W)	Zinc	(2) #8-32 x 1in Truss Head Machine Screw (2) #8-32 x 1-1/2in Truss Head Machine Screw	N/A
BP36623BBZ	Pull	Golden Champagne	6-5/16 (160) CTC	7-1/2 (191)	1 (25)	1-3/8 (35)	15/16 L x 15/16 W (24 L x 24 W)	Zinc	(2) #8-32 x 1in Truss Head Machine Screw (2) #8-32 x 1-1/2in Truss Head Machine Screw	N/A
BP36623G10	Pull	Satin Nickel	6-5/16 (160) CTC	7-1/2 (191)	1 (25)	1-3/8 (35)	15/16 L x 15/16 W (24 L x 24 W)	Zinc	(2) #8-32 x 1in Truss Head Machine Screw (2) #8-32 x 1-1/2in Truss Head Machine Screw	N/A
BP36623ORB	Pull	Oil-Rubbed Bronze	6-5/16 (160) CTC	7-1/2 (191)	1 (25)	1-3/8 (35)	15/16 L x 15/16 W (24 L x 24 W)	Zinc	(2) #8-32 x 1in Truss Head Machine Screw (2) #8-32 x 1-1/2in Truss Head Machine Screw	N/A
<b>Arrondi Hooks • p. 25</b>										
BH26542BBZ	Robe Hook	Golden Champagne	Single	2-1/4 (57)	1-15/16 (49)	2-1/8 (54)	1-15/16 L x 1-15/16 W (49 L x 49 W)	Stainless Steel	(2) #8 x 1-1/4 in. Sheet Metal Screw (1) Mounting Bracket	N/A
BH26542CZ	Robe Hook	Champagne Bronze	Single	2-1/4 (57)	1-15/16 (49)	2-1/8 (54)	1-15/16 L x 1-15/16 W (49 L x 49 W)	Stainless Steel	(2) #8 x 1-1/4 in. Sheet Metal Screw (1) Mounting Bracket	N/A
BH26542MB	Robe Hook	Matte Black	Single	2-1/4 (57)	1-15/16 (49)	2-1/8 (54)	1-15/16 L x 1-15/16 W (49 L x 49 W)	Stainless Steel	(2) #8 x 1-1/4 in. Sheet Metal Screw (1) Mounting Bracket	N/A
BH26542ORB	Robe Hook	Oil-Rubbed Bronze	Single	2-1/4 (57)	1-15/16 (49)	2-1/8 (54)	1-15/16 L x 1-15/16 W (49 L x 49 W)	Stainless Steel	(2) #8 x 1-1/4 in. Sheet Metal Screw (1) Mounting Bracket	N/A
BH26542PSS	Robe Hook	Polished Stainless Steel	Single	2-1/4 (57)	1-15/16 (49)	2-1/8 (54)	1-15/16 L x 1-15/16 W (49 L x 49 W)	Stainless Steel	(2) #8 x 1-1/4 in. Sheet Metal Screw (1) Mounting Bracket	N/A
BH26542SS	Robe Hook	Stainless Steel	Single	2-1/4 (57)	1-15/16 (49)	2-1/8 (54)	1-15/16 L x 1-15/16 W (49 L x 49 W)	Stainless Steel	(2) #8 x 1-1/4 in. Sheet Metal Screw (1) Mounting Bracket	N/A
<b>Appoint Hooks • p. 25</b>										
BH3607026	Robe Hook	Chrome	Single	1-7/8 (48)	1-7/8 (48)	2-1/2 (64)	1-7/8 L x 1-7/8 W (48 L x 48 W)	Zinc	(2) #8 x 1-1/4 in. Sheet Metal Screw (1) Mounting Bracket	N/A
BH36070BBZ	Robe Hook	Golden Champagne	Single	1-7/8 (48)	1-7/8 (48)	2-1/2 (64)	1-7/8 L x 1-7/8 W (48 L x 48 W)	Zinc	(2) #8 x 1-1/4 in. Sheet Metal Screw (1) Mounting Bracket	N/A
BH36070CZ	Robe Hook	Champagne Bronze	Single	1-7/8 (48)	1-7/8 (48)	2-1/2 (64)	1-7/8 L x 1-7/8 W (48 L x 48 W)	Zinc	(2) #8 x 1-1/4 in. Sheet Metal Screw (1) Mounting Bracket	N/A
BH36070G10	Robe Hook	Brushed Nickel	Single	1-7/8 (48)	1-7/8 (48)	2-1/2 (64)	1-7/8 L x 1-7/8 W (48 L x 48 W)	Zinc	(2) #8 x 1-1/4 in. Sheet Metal Screw (1) Mounting Bracket	N/A
BH36070MB	Robe Hook	Matte Black	Single	1-7/8 (48)	1-7/8 (48)	2-1/2 (64)	1-7/8 L x 1-7/8 W (48 L x 48 W)	Zinc	(2) #8 x 1-1/4 in. Sheet Metal Screw (1) Mounting Bracket	N/A
BH36070ORB	Robe Hook	Oil-Rubbed Bronze	Single	1-7/8 (48)	1-7/8 (48)	2-1/2 (64)	1-7/8 L x 1-7/8 W (48 L x 48 W)	Zinc	(2) #8 x 1-1/4 in. Sheet Metal Screw (1) Mounting Bracket	N/A
<b>Monument Hooks • p. 25</b>										
BH3608026	Robe Hook	Chrome	Single	7/8 (22)	7/8 (22)	2-3/8 (60)	7/8 L x 7/8 W (22 L x 22 W)	Zinc	(2) #8 x 1-1/4 in. Sheet Metal Screw (1) Mounting Bracket	N/A
BH36080BBZ	Robe Hook	Golden Champagne	Single	7/8 (22)	7/8 (22)	2-3/8 (60)	7/8 L x 7/8 W (22 L x 22 W)	Zinc	(2) #8 x 1-1/4 in. Sheet Metal Screw (1) Mounting Bracket	N/A
BH36080CZ	Robe Hook	Champagne Bronze	Single	7/8 (22)	7/8 (22)	2-3/8 (60)	7/8 L x 7/8 W (22 L x 22 W)	Zinc	(2) #8 x 1-1/4 in. Sheet Metal Screw (1) Mounting Bracket	N/A

Mounting hardware included.  
The dimensional information provided here should be verified with the actual product prior to drilling or attempting to install the hardware.  
Please direct any questions you may have on the installation process to Amerock Customer Service (see back cover for contact information).

# PRODUCT INDEX

Product No.	Type	Finish	Product Detail in (mm)	Length in (mm)	Width in (mm)	Projection in (mm)	Base Dimensions in (mm)	Base Material	Mounting Hardware Included	ADA-Friendly
<b>Monument Hooks (continued) • p. 25</b>										
BH36080G10	Robe Hook	Brushed Nickel	Single	7/8 (22)	7/8 (22)	2-3/8 (60)	7/8 L x 7/8 W (22 L x 22 W)	Zinc	(2) #8 x 1-1/4 in. Sheet Metal Screw (1) Mounting Bracket	N/A
BH36080MB	Robe Hook	Matte Black	Single	7/8 (22)	7/8 (22)	2-3/8 (60)	7/8 L x 7/8 W (22 L x 22 W)	Zinc	(2) #8 x 1-1/4 in. Sheet Metal Screw (1) Mounting Bracket	N/A
BH36080ORB	Robe Hook	Oil-Rubbed Bronze	Single	7/8 (22)	7/8 (22)	2-3/8 (60)	7/8 L x 7/8 W (22 L x 22 W)	Zinc	(2) #8 x 1-1/4 in. Sheet Metal Screw (1) Mounting Bracket	N/A
<b>Stature Hooks • p. 25</b>										
BH3609026	Robe Hook	Chrome	Single	2-1/4 (57)	2-1/4 (57)	2-1/2 (64)	2-1/4 L x 2-1/4 W (57 L x 57 W)	Zinc	(2) #8 x 1-1/4 in. Sheet Metal Screw (1) Mounting Bracket	N/A
BH36090BBZ	Robe Hook	Golden Champagne	Single	2-1/4 (57)	2-1/4 (57)	2-1/2 (64)	2-1/4 L x 2-1/4 W (57 L x 57 W)	Zinc	(2) #8 x 1-1/4 in. Sheet Metal Screw (1) Mounting Bracket	N/A
BH36090CZ	Robe Hook	Champagne Bronze	Single	2-1/4 (57)	2-1/4 (57)	2-1/2 (64)	2-1/4 L x 2-1/4 W (57 L x 57 W)	Zinc	(2) #8 x 1-1/4 in. Sheet Metal Screw (1) Mounting Bracket	N/A
BH36090G10	Robe Hook	Brushed Nickel	Single	2-1/4 (57)	2-1/4 (57)	2-1/2 (64)	2-1/4 L x 2-1/4 W (57 L x 57 W)	Zinc	(2) #8 x 1-1/4 in. Sheet Metal Screw (1) Mounting Bracket	N/A
BH36090MB	Robe Hook	Matte Black	Single	2-1/4 (57)	2-1/4 (57)	2-1/2 (64)	2-1/4 L x 2-1/4 W (57 L x 57 W)	Zinc	(2) #8 x 1-1/4 in. Sheet Metal Screw (1) Mounting Bracket	N/A
BH36090ORB	Robe Hook	Oil-Rubbed Bronze	Single	2-1/4 (57)	2-1/4 (57)	2-1/2 (64)	2-1/4 L x 2-1/4 W (57 L x 57 W)	Zinc	(2) #8 x 1-1/4 in. Sheet Metal Screw (1) Mounting Bracket	N/A

Mounting hardware included.

The dimensional information provided here should be verified with the actual product prior to drilling or attempting to install the hardware. Please direct any questions you may have on the installation process to Amerock Customer Service (see back cover for contact information).



EST. 1928

*get in touch*

Rediscover Amerock **for yourself.**

[amerock.customersupport@amerock.com](mailto:amerock.customersupport@amerock.com)

P: 1-800-435-6959

F: 1-800-618-6733

10115 Kincey Ave, Suite 210

Huntersville, NC 28078

**Amerock.com**



©2022