

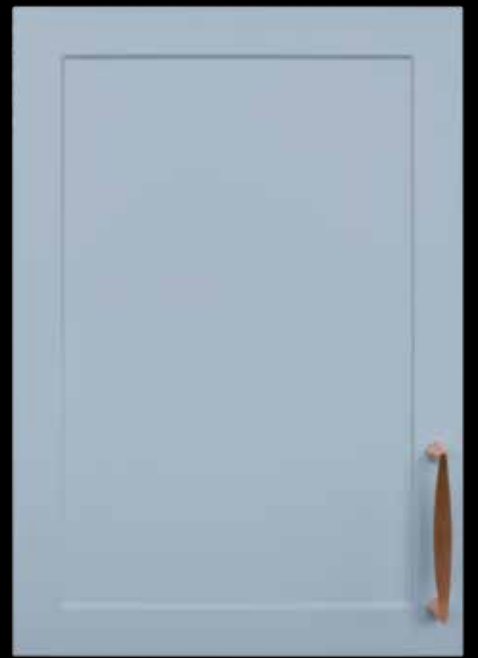

 **Berenson™**

**SUIT
YOUR
*Style***



2026 PRODUCT CATALOG





Contents

Simplicity & Online Ordering 4

CLASSIC COMFORT 5

Aspire	7
Brookridge	9
Cannelee	11
Connections	13
Designers' Group Ten	15
Dierdra	17
Domestic Bliss	21
Euro Moderno	23
Meadow	25
Oasis	27
Rivet Rebel	29
Subtle Surge	31
Tempo	33
Appliance Pulls	37

UPTOWN APPEAL 45

Bravo	47
Elevate	49
Epoch Edge	51
Fluidic	53
Laura	55
Metro	59
Radial Reign	61
Roque	67
Skyline	69
Stainless Steel	71
Studio	72
Studio Remix	73
Swagger	75
Appliance Pulls	77

TIMELESS CHARM 85

Echo	87
Emerling	89
Folklore	93
Harmony	95
Hearthstone	97
Tailored Traditional	99
Vested Interest	101
Vibrato	103
Village	105
Appliance Pulls	107

ARTISAN INSPIRED 113

Art Nouveau	115
Rhapsody	116

COMPLETE THE LOOK 117

Galloway	119
Statler	121
Prelude	123
Berenson Knobs	125
Finish Guide	127
Suggested Pairings	129
Display Boards	131
Display Towers	143
Display Accessories	144
Additional Lines	145
Installation Guide	147
Key to Codes	150
Part Number Index	151
FAQ	162

Look for NEW Collections

Featuring the Emerling Collection
in Modern Brushed Gold
with 1in. Sample Clip



About Berenson

Berenson Hardware is committed to providing an exceptional customer experience. We offer quality hardware backed by an industry-leading sample program and reliable same-day shipping.

Berenson Hardware offers trend-forward collections ranging from timeless classics to modern designs for every space.



Online Access

Industry professionals can activate an account on BerensonHardware.com.

Enjoy 24/7 access to your account tools, including Order Tracking, Recent Orders, Invoices and Backorders.

NOT A DIRECT BUYER?

You can still create a web account to:

- View product availability
- Save favorites
- Request free samples



Smplicity

OUR FREE SAMPLE PROGRAM

Choosing the right hardware just got easier. With Berenson's Smplicity sample program, you can order up to 5 free samples and see how our knobs and pulls look and feel in your space — before you commit!

WHAT'S INCLUDED?

- Free samples of Berenson and Advantage Plus by Berenson knobs and pulls (160mm CC or smaller)
- Up to 5 total samples—limit 1 piece per style
- Fast, free USPS shipping
- Bonus Free Sample Clip! Each order includes a free Smplicity clip—so you can test your hardware without drilling.
 - 1" Clip – best for doors
 - 3" Clip – best for drawers

FIND A STORE

Looking to shop in person? Use our Find a Store page to locate nearby showrooms and distributors —just enter your zip code or address.

Not Included: Hooks, appliance pulls. R. Christensen by Berenson items and pulls longer than 160mm CC are available for samples at 50% off MSRP + \$4 flat-rate shipping.

Samples are for review only. For display boards or merchandising options, contact us to explore your best fit.



Featuring the Metro Collection in
Brushed Nickel with 3in. Sample Clip

TRANSITIONAL STYLE

Classic Comfort

Effortlessly blend elements like modern, soft curves into time-honored hardware designs and achieve transitional bliss.



Cannelee
in Modern Brushed Gold



Aspire

FEATURED IN BRUSHED TIN

View display board on p. 133



12in. CC

160mm CC

128mm CC

96mm CC

Knob
has pin at bottom to help secure in position

CC	PRODUCT TYPE	LENGTH	WIDTH	HEIGHT/ PROJECTION	HAND CLEARANCE	DIAMETER	BASE	TAP/SCREWS (QTY)
*18in.	Appliance Pull	18 3/8in.	1 1/2in.	1 13/16in.	1 3/8in.	-	1/2in.	10-24 x 1in. (2)
12in.	Appliance Pull	12 7/16in.	1in.	1 13/16in.	1 1/4in.	-	7/16in.	10-24 x 1in. (2)
160mm	Pull	6 1/2in.	1 1/16in.	1 1/4in.	1 5/16in.	-	5/16in.	8-32 x 1in. (2)
128mm	Pull	5 7/16in.	3/4in.	1 1/4in.	1 5/16in.	-	5/16in.	8-32 x 1in. (2)
96mm	Pull	4 1/8in.	23/32in.	1 1/4in.	1 3/8in.	-	5/16in.	8-32 x 1in. (2)
-	Knob	1 1/4in.	3/4in.	1 3/16in.	6 1/4in.	-	1 1/16in.	8-32 x 1in. (1)

*Product not shown, please visit BerensonHardware.com to view images and details.

Collection Material: Zinc

ASPIRE AVAILABLE FINISHES, SIZES & PART NUMBERS

Handle Underside: Flat



BRUSHED COPPER

18in. CC	<i>Not Available</i>
12in. CC	2145-10BC-P
160mm CC	2144-10BC-P
128mm CC	2143-10BC-P
96mm CC	2142-10BC-P
Knob	2146-10BC-P



BRUSHED NICKEL

18in. CC	2148-1BPN-P
12in. CC	9240-1BPN-P
160mm CC	9237-1BPN-P
128mm CC	9234-1BPN-P
96mm CC	9231-1BPN-P
Knob	9243-1BPN-P



BRUSHED TIN

18in. CC	2149-10BT-P
12in. CC	9241-10BT-P
160mm CC	9238-10BT-P
128mm CC	9235-10BT-P
96mm CC	9232-10BT-P
Knob	9244-10BT-P



MATTE BLACK

18in. CC	2140-1055-P
12in. CC	2139-1055-P
160mm CC	2138-1055-P
128mm CC	2137-1055-P
96mm CC	2136-1055-P
Knob	2141-1055-P



MODERN BRUSHED GOLD

18in. CC	2134-1MDB-P
12in. CC	2133-1MDB-P
160mm CC	2132-1MDB-P
128mm CC	2131-1MDB-P
96mm CC	2130-1MDB-P
Knob	2135-1MDB-P



POLISHED CHROME

18in. CC	2147-1026-P
12in. CC	92839-1026-P
160mm CC	9236-1026-P
128mm CC	9233-1026-P
96mm CC	9230-1026-P
Knob	9242-1026-P



VERONA BRONZE

18in. CC	2150-10VB-P
12in. CC	2032-10VB-P
160mm CC	2031-10VB-P
128mm CC	2030-10VB-P
96mm CC	2029-10VB-P
Knob	2033-10VB-P

Brookridge

FEATURED IN VERONA BRONZE

View display board on p. 133



CC	PRODUCT TYPE	LENGTH	WIDTH	HEIGHT/ PROJECTION	HAND CLEARANCE	DIAMETER	BASE	TAP/SCREWS (QTY)
*18in.	Appliance Pull	18 2 ⁵ / ₃₂ in.	1 ⁵ / ₁₆ in.	2in.	1 1/2in.	-	2 ³ / ₃₂ in.	10-24 x 1in. (2)
*12in.	Appliance Pull	12 3/4in.	2 ⁷ / ₃₂ in.	1 3/4in.	1 2 ¹ / ₆₄ in.	-	1 ⁹ / ₃₂ in.	10-24 x 1in. (2)
224mm	Pull	9 1 ¹ / ₃₂ in.	1 ¹ / ₁₆ in.	1 3/8in.	1 1/2in.	-	1 ⁹ / ₃₂ in.	8-32 x 1in. (2)
160mm	Pull	6 1 ¹ / ₁₆ in.	1 ⁵ / ₃₂ in.	1 1/4in.	3 ¹ / ₃₂ in.	-	1/2in.	8-32 x 1in. (2)
128mm	Pull	5 7/16in.	1 ⁵ / ₃₂ in.	1 1/4in.	3 ¹ / ₃₂ in.	-	1/2in.	8-32 x 1in. (2)
96mm	Pull	4 3/16in.	1 ⁵ / ₃₂ in.	1 1/4in.	3 ¹ / ₃₂ in.	-	1/2in.	8-32 x 1in. (2)
-	① Knob	-	-	1 7/32in.	2 ³ / ₃₂ in.	1 3/32in.	1/2in.	8-32 x 1in. (1)
-	② Knob	1 3/8in.	1 3/8in.	1 7/32in.	3/4in.	-	1/2in.	8-32 x 1in. (1)

*Product not shown, please visit BerensonHardware.com to view images and details.

Collection Material: Zinc

BROOKRIDGE AVAILABLE FINISHES, SIZES & PART NUMBERS

Handle Underside: Semi-Curved

BRUSHED NICKEL		MATTE BLACK		MODERN BRUSHED GOLD	
18in. CC	2657-1BPN-P	18in. CC	2658-1055-P	18in. CC	2659-1MDB-P
12in. CC	2635-1BPN-P	12in. CC	2636-1055-P	12in. CC	2639-1MDB-P
224mm CC	2630-1BPN-P	224mm CC	2631-1055-P	224mm CC	2634-1MDB-P
160mm CC	2625-1BPN-P	160mm CC	2626-1055-P	160mm CC	2629-1MDB-P
128mm CC	2620-1BPN-P	128mm CC	2621-1055-P	128mm CC	2624-1MDB-P
96mm CC	2615-1BPN-P	96mm CC	2616-1055-P	96mm CC	2619-1MDB-P
① Knob	2640-1BPN-P	① Knob	2641-1055-P	① Knob	2644-1MDB-P
② Knob	2645-1BPN-P	② Knob	2646-1055-P	② Knob	2649-1MDB-P

POLISHED CHROME		VERONA BRONZE	
18in. CC	Not Available	18in. CC	Not Available
12in. CC	2654-1026-P	12in. CC	2637-10VB-P
224mm CC	2653-1026-P	224mm CC	2632-10VB-P
160mm CC	2652-1026-P	160mm CC	2627-10VB-P
128mm CC	2651-1026-P	128mm CC	2622-10VB-P
96mm CC	2650-1026-P	96mm CC	2617-10VB-P
① Knob	2655-1026-P	① Knob	2642-10VB-P
② Knob	2656-1026-P	② Knob	2647-10VB-P



Cannelee

NEW COLLECTION
SPRING 2026

FEATURED IN MODERN BRUSHED GOLD

View display board on p. 133



CANNELEE AVAILABLE FINISHES, SIZES & PART NUMBERS

Handle Underside: Curved



BRUSHED NICKEL

12in. CC	2897-1BPN-P
224mm CC	2894-1BPN-P
160mm CC	2891-1BPN-P
128mm CC	2888-1BPN-P
96mm CC	2885-1BPN-P
Knob	2882-1BPN-P



MATTE BLACK

12in. CC	2898-1055-P
224mm CC	2895-1055-P
160mm CC	2892-1055-P
128mm CC	2889-1055-P
96mm CC	2886-1055-P
Knob	2883-1055-P



MODERN BRUSHED GOLD

12in. CC	2899-1MDB-P
224mm CC	2896-1MDB-P
160mm CC	2893-1MDB-P
128mm CC	2890-1MDB-P
96mm CC	2887-1MDB-P
Knob	2884-1MDB-P



CC	PRODUCT TYPE	LENGTH	WIDTH	HEIGHT/ PROJECTION	HAND CLEARANCE	DIAMETER	BASE	TAP/SCREWS (QTY)
*12in.	Appliance Pull	13 1/16in.	1 1/16in.	1 23/32in.	1 5/16in.	-	1 1/16in.	10-24 x 1in. (2)
224mm	Pull	9 3/4in.	1 5/16in.	1 1/2in.	1 3/8in.	-	1 5/16in.	8-32 x 1in. (2)
160mm	Pull	7 7/32in.	2 9/32in.	1 1 3/32in.	1 3/8in.	-	2 9/32in.	8-32 x 1in. (2)
128mm	Pull	5 1/2in.	7/8in.	1 1 1/32in.	1 3/8in.	-	7/8in.	8-32 x 1in. (2)
96mm	Pull	4 2 1/2in.	7/8in.	1 1 1/32in.	1 3/8in.	-	7/8in.	8-32 x 1in. (2)
-	Knob	-	-	1 3/16in.	-	1 3/16in.	7/8in.	8-32 x 1in. (1)

*Product not shown, please visit BerensonHardware.com to view images and details.

Collection Material: Zinc



Connections

FEATURED IN VERONA BRONZE

View display board on p. 133



160mm CC



96mm CC



3in. CC



Knob
has pin at bottom to help secure in position

CC	PRODUCT TYPE	LENGTH	WIDTH	HEIGHT/ PROJECTION	HAND CLEARANCE	DIAMETER	BASE	TAP/SCREWS (QTY)
160mm	Pull	6 7/8in.	3/4in.	1 1/4in.	2 5/8in.	-	3/8in.	8-32 x 1in. (2)
96mm	Pull	4 5/8in.	1/2in.	1 1/4in.	2 5/8in.	-	3/8in.	8-32 x 1in. (2)
3in.	Pull	3 1/2in.	1/2in.	1 1/4in.	2 7/8in.	-	3/8in.	8-32 x 1in. (2)
-	Knob	1 1/8in.	1 1/8in.	1 1/8in.	-	-	3/8in.	8-32 x 1in. (1)

Collection Material: Zinc

CONNECTIONS AVAILABLE FINISHES, SIZES & PART NUMBERS

Handle Underside: Curved



MATTE BLACK

160mm CC	4005-1055-P
96mm CC	4131-1055-P
3in. CC	4002-1055-P
Knob	4008-1055-P



VERONA BRONZE

160mm CC	4006-10VB-P
96mm CC	4132-10VB-P
3in. CC	4003-10VB-P
Knob	4009-10VB-P



VINTAGE NICKEL

160mm CC	4004-1VTN-P
96mm CC	4130-1VTN-P
3in. CC	4001-1VTN-P
Knob	4007-1VTN-P



Designers' Group Ten

ONLY AVAILABLE IN POLISHED NICKEL

View display board on p. 133

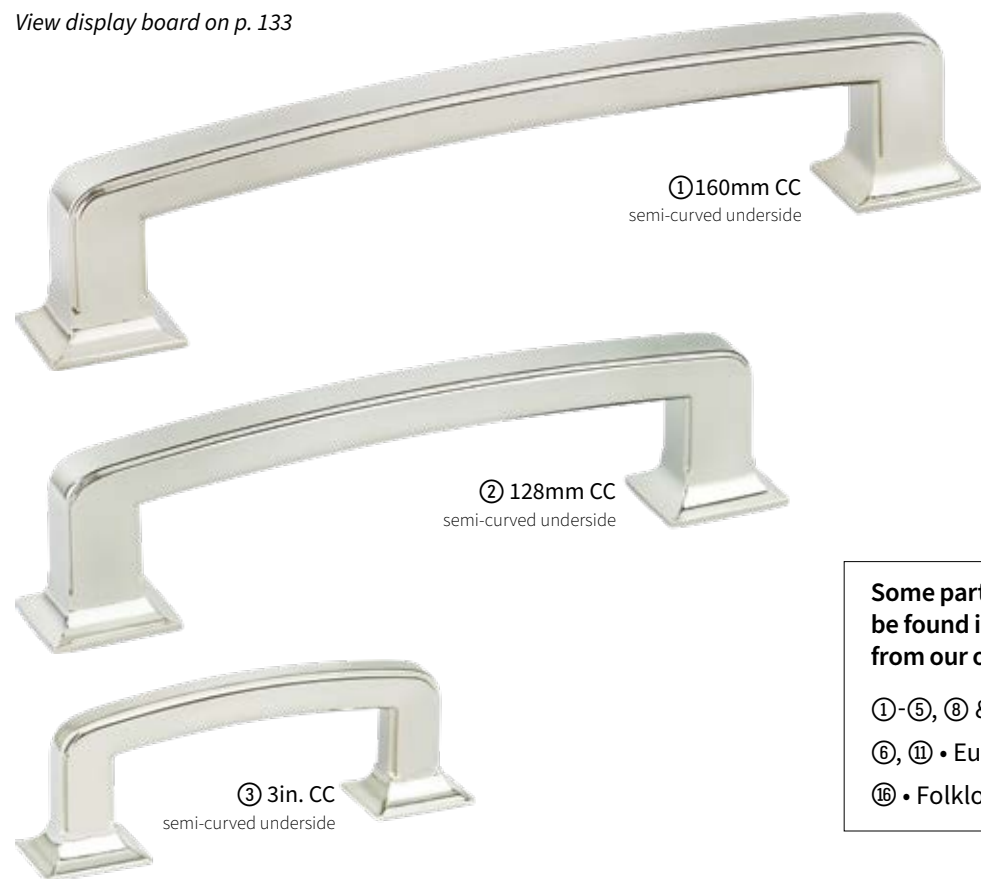

① 160mm CC
semi-curved underside

② 128mm CC
semi-curved underside

③ 3in. CC
semi-curved underside

Some parts in this collection can be found in additional finishes from our other collections.

①-⑤, ⑧ & Appliance Pulls • Hearthstone - p. 97

⑥, ⑪ • Euro Moderno - p. 23

⑫ • Folklore - p. 93

	PART NO.	CC	PRODUCT TYPE	LENGTH	WIDTH	HEIGHT/ PROJECTION	HAND CLEARANCE	DIAMETER	BASE	TAP/SCREWS (QTY)
	4154-1014-P	*18in.	Appliance Pull	19 1/4in.	1 1/2in.	1 3/8in.	1 3/8in.	-	1 3/8in.	10-24 x 1in. (2)
	2036-1014-P	*12in.	Appliance Pull	13 3/8in.	3/4in.	1 13/16in.	1 23/64in.	-	1 1/8in.	10-24 x 1in. (2)
1	2046-1014-P	160mm	Pull	7 5/8in.	3/4in.	1 1/2in.	1 23/64in.	-	7/8in.	8-32 x 1in. (2)
2	+2041-1014-P	128mm	Pull	6 1/8in.	1/2in.	1 7/8in.	1 1/8in.	-	7/8in.	8-32 x 1in. (2)
3	4139-1014-P	3in.	Pull	3 15/16in.	3/4in.	1 3/8in.	61/64in.	-	1 3/8in.	8-32 x 1in. (2)
4	4141-1014-P	**6in.	Pull	7 3/8in.	1 1/8in.	1 11/16in.	1 5/32in.	-	1 1/8in.	8-32 x 1in. (2)
5	+4140-1014-P	96mm	Pull	4 13/16in.	3/4in.	1 3/8in.	61/64in.	-	7/8in.	8-32 x 1in. (2)
6	4144-1014-P	96mm	Pull	5 1/4in.	5/8in.	1 5/8in.	23/32in.	-	7/8in.	8-32 x 1in. (2)
7	4149-1014-P	**6in.	Pull	6 5/8in.	1 1/8in.	1 7/8in.	1 1/32in.	-	3/4in.	8-32 x 1in. (2)
8	4142-1014-P	-	Knob	1 3/8in.	1 1/8in.	1 1/8in.	3/4in.	-	1 3/8in.	8-32 x 1in. (1)
9	4147-1014-P	4in.	Pull	4 3/8in.	1/2in.	1 1/4in.	51/64in.	-	3/4in.	8-32 x 1in. (2)
10	4145-1014-P	-	Knob	-	-	1 1/8in.	1 1/8in.	1 3/8in.	1in.	8-32 x 1in. (1)
11	4143-1014-P	-	Knob	-	-	1 1/8in.	-	1 1/8in.	1 1/8in.	8-32 x 1in. (1)
12	4148-1014-P	3in.	Pull	3 1/2in.	1/2in.	1 3/8in.	51/64in.	-	3/4in.	8-32 x 1in. (2)
13	4150-1014-P	-	Knob	-	-	1 1/8in.	-	1 1/4in.	1 1/8in.	8-32 x 1in. (1)
14	4152-1014-P	-	Knob	-	-	1 1/8in.	-	1 3/8in.	1 1/8in.	8-32 x 1in. (1)
15	4153-1014-P	96mm	Pull	4 3/8in.	1/2in.	1 3/8in.	3/4in.	-	3/4in.	8-32 x 1in. (2)
16	4146-1014-P	3in.	Cup Pull	4 11/16in.	1 1/8in.	1 1/8in.	51/64in.	-	-	8-32 x 1in. (2)

*Product not shown, please visit BerensonHardware.com to view images and details.

**The 6in. CC pulls feature a wider width that adds dimension to kitchen and bath designs.

+2 Additional 8-32 x 1 3/4in. break-off screws provided.



④ **6in. CC
semi-curved underside

⑥ 96mm CC
curved underside

⑤ 96mm CC
semi-curved underside

⑦ **6in. CC
curved underside

⑧ Knob
has pin at bottom to help hold in position

⑨ 4in. CC
curved underside

⑩ Knob

⑪ Knob

⑬ Knob

⑭ Knob

⑫ 3in. CC
curved underside

⑮ 96mm CC
curved underside

⑯ 3in. CC
curved underside

Dierdra

FEATURED IN TOASTED BRONZE

View display board on p. 133



DIERDRA AVAILABLE FINISHES, SIZES & PART NUMBERS

Handle Underside: Curved



BRUSHED NICKEL

12in. CC	9854-1BPN-P
224mm CC	9564-1BPN-P
160mm CC	9562-1BPN-P
128mm CC	9853-1BPN-P
96mm CC	4056-1BPN-P
Knob	4061-1BPN-P



MATTE BLACK

12in. CC	4172-1055-P
224mm CC	4169-1055-P
160mm CC	4168-1055-P
128mm CC	4167-1055-P
96mm CC	4157-1055-P
Knob	4158-1055-P



MODERN BRUSHED GOLD

12in. CC	4166-1MDB-P
224mm CC	4165-1MDB-P
160mm CC	4164-1MDB-P
128mm CC	4163-1MDB-P
96mm CC	4160-1MDB-P
Knob	4162-1MDB-P



POLISHED NICKEL

12in. CC	9852-1014-P
224mm CC	9568-1014-P
160mm CC	9567-1014-P
128mm CC	9835-1014-P
96mm CC	4107-1014-P
Knob	4110-1014-P



TOASTED BRONZE

12in. CC	4218-10TB-P
224mm CC	4217-10TB-P
160mm CC	4216-10TB-P
128mm CC	4215-10TB-P
96mm CC	4214-10TB-P
Knob	4213-10TB-P



VINTAGE NICKEL

12in. CC	9804-1VTN-P
224mm CC	9808-1VTN-P
160mm CC	9807-1VTN-P
128mm CC	9803-1VTN-P
96mm CC	9806-1VTN-P
Knob	9809-1VTN-P

CC	PRODUCT TYPE	LENGTH	WIDTH	HEIGHT/ PROJECTION	HAND CLEARANCE	DIAMETER	BASE	TAP/SCREWS (QTY)
*12in.	Appliance Pull	13 1/4in.	7/8in.	1 2 1/2in.	1 1/8in.	-	3/8in.	10-24 x 1in. (2)
224mm	Pull	9 1/2in.	5/8in.	1 3/8in.	1 1/4in.	-	1/2in.	8-32 x 1in. (2)
160mm	Pull	6 1 1/8in.	5/8in.	1 1/2in.	1 1/8in.	-	1/2in.	8-32 x 1in. (2)
128mm	Pull	5 2 3/8in.	5/8in.	1 1 1/2in.	7/8in.	-	3/8in.	8-32 x 1in. (2)
96mm	Pull	4 1/2in.	5/8in.	1 3/8in.	1 1/4in.	-	3/8in.	8-32 x 1in. (2)
-	Knob	1 7/8in.	1in.	1 3/8in.	5/8in.	-	3/8in.	8-32 x 1in. (1)

*Product not shown, please visit BerensonHardware.com to view images and details.

Collection Material: Zinc



Domestic Bliss
in NEW Brushed Copper



Subtle Surge
in Matte Black

Domestic Bliss

NEW FINISHES
NOW AVAILABLE

FEATURED IN MODERN BRUSHED GOLD

View display board on p. 134



CC	PRODUCT TYPE	LENGTH	WIDTH	HEIGHT/ PROJECTION	HAND CLEARANCE	DIAMETER	BASE	TAP/SCREWS (QTY)
*18in.	Appliance Pull	19 3/32in.	1 3/16in.	2 3/32in.	1 1/32in.	-	1 5/32in.	10-24 x 1in. (2)
*320mm	Pull	13 1/2in.	1 in.	1 1/2in.	1 1/16in.	-	1 5/16in.	8-32 x 1in. (2)
224mm	Pull	9 3/4in.	1 3/16in.	1 1/2in.	1 1/16in.	-	1 5/16in.	8-32 x 1in. (2)
160mm	Pull	7 1/8in.	3/4in.	1 7/16in.	1 1/16in.	-	7/8in.	8-32 x 1in. (2)
128mm	Pull	5 3/4in.	5/8in.	1 3/8in.	1 1/16in.	-	3/4in.	8-32 x 1in. (2)
96mm	Pull	4 1/2in.	5/8in.	1 3/8in.	1 1/16in.	-	3/4in.	8-32 x 1in. (2)
-	Knob	-	-	1 1/8in.	-	1 3/16in.	1 1/16in.	8-32 x 1in. (1)

*Product not shown, please visit BerensonHardware.com to view images and details.

Collection Material: Zinc

DOMESTIC BLISS AVAILABLE FINISHES, SIZES & PART NUMBERS

Handle Underside: Curved



BRUSHED COPPER

18in. CC	Not Available
320mm CC	2425-10BC-P
224mm CC	2424-10BC-P
160mm CC	2423-10BC-P
128mm CC	2381-10BC-P
96mm CC	2422-10BC-P
Knob	2383-10BC-P



BRUSHED NICKEL

18in. CC	2419-1BPN-P
320mm CC	2356-1BPN-P
224mm CC	2352-1BPN-P
160mm CC	2348-1BPN-P
128mm CC	2343-1BPN-P
96mm CC	2339-1BPN-P
Knob	2360-1BPN-P



MATTE BLACK

18in. CC	2420-1055-P
320mm CC	2410-1055-P
224mm CC	2409-1055-P
160mm CC	2402-1055-P
128mm CC	2401-1055-P
96mm CC	2400-1055-P
Knob	2399-1055-P



MODERN BRUSHED GOLD

18in. CC	2421-1MDB-P
320mm CC	2359-1MDB-P
224mm CC	2355-1MDB-P
160mm CC	2351-1MDB-P
128mm CC	2347-1MDB-P
96mm CC	2342-1MDB-P
Knob	2363-1MDB-P



POLISHED NICKEL

18in. CC	Not Available
320mm CC	2358-1014-P
224mm CC	2354-1014-P
160mm CC	2350-1014-P
128mm CC	2346-1014-P
96mm CC	2341-1014-P
Knob	2362-1014-P



SLATE

18in. CC	Not Available
320mm CC	2408-1SLT-P
224mm CC	2407-1SLT-P
160mm CC	2406-1SLT-P
128mm CC	2405-1SLT-P
96mm CC	2404-1SLT-P
Knob	2403-1SLT-P



TOASTED BRONZE

18in. CC	Not Available
320mm CC	2433-10TB-P
224mm CC	2432-10TB-P
160mm CC	2429-10TB-P
128mm CC	2428-10TB-P
96mm CC	2427-10TB-P
Knob	2426-10TB-P



VERONA BRONZE

18in. CC	Not Available
320mm CC	2357-10VB-P
224mm CC	2353-10VB-P
160mm CC	2349-10VB-P
128mm CC	2344-10VB-P
96mm CC	2340-10VB-P
Knob	2361-10VB-P

Euro Moderno

FEATURED IN BRUSHED NICKEL

View display board on p. 134



96mm CC



64mm CC



Knob

CC	PRODUCT TYPE	LENGTH	WIDTH	HEIGHT/ PROJECTION	HAND CLEARANCE	DIAMETER	BASE	TAP/SCREWS (QTY)
96mm	Pull	5 1/4in.	5/8in.	1 5/16in.	2 3/32in.	-	7/8in.	8-32 x 1in. (2)
64mm	Cup Pull	3 1/4in.	1 1/8in.	1 5/16in.	2 7/32in.	-	-	8-32 x 1in. (2)
-	Knob	-	-	1 1/16in.	3 3/64in.	1 1/8in.	5/8in.	8-32 x 1in. (1)

*Product not shown, please visit BerensonHardware.com to view images and details.

Collection Material: Zinc

EURO MODERNO AVAILABLE FINISHES, SIZES & PART NUMBERS

Handle Underside: Curved



BRUSHED ANTIQUE BRASS

96mm CC	9721-1BAB-P
64mm CC	9713-1BAB-P
Knob	9724-1BAB-P



BRUSHED ANTIQUE COPPER

96mm CC	9719-1BAC-P
64mm CC	9711-1BAC-P
Knob	9722-1BAC-P



BRUSHED BLACK NICKEL

96mm CC	9720-1BBN-P
64mm CC	9712-1BBN-P
Knob	9723-1BBN-P



BRUSHED NICKEL

96mm CC	9718-1BPN-P
64mm CC	9710-1BPN-P
Knob	9913-1BPN-P



Meadow

FEATURED IN VERONA BRONZE
View display board on p. 134



256mm CC

160mm CC

128mm CC

96mm CC

Knob
has pin at bottom to help secure in position

MEADOW AVAILABLE FINISHES, SIZES & PART NUMBERS

Handle Underside: Curved



BRUSHED NICKEL

448mm CC	2302-4BPN-P
320mm CC	2308-4BPN-P
256mm CC	2306-4BPN-P
160mm CC	2304-4BPN-P
128mm CC	2099-4BPN-P
96mm CC	2097-4BPN-P
Knob	2310-1BPN-P



GRAPHITE

448mm CC	2285-4GPH-P
320mm CC	2284-4GPH-P
256mm CC	2283-4GPH-P
160mm CC	2282-4GPH-P
128mm CC	2281-4GPH-P
96mm CC	2280-4GPH-P
Knob	2286-4GPH-P



MATTE BLACK

448mm CC	2292-4055-P
320mm CC	2291-4055-P
256mm CC	2290-4055-P
160mm CC	2289-4055-P
128mm CC	2288-4055-P
96mm CC	2287-4055-P
Knob	2293-4055-P



POLISHED CHROME

448mm CC	2299-4026-P
320mm CC	2298-4026-P
256mm CC	2297-4026-P
160mm CC	2296-4026-P
128mm CC	2295-4026-P
96mm CC	2294-4026-P
Knob	2300-4026-P



SATIN GOLD

448mm CC	2278-40SG-P
320mm CC	2277-40SG-P
256mm CC	2276-40SG-P
160mm CC	2275-40SG-P
128mm CC	2274-40SG-P
96mm CC	2273-40SG-P
Knob	2279-40SG-P



VERONA BRONZE

448mm CC	2301-40VB-P
320mm CC	2309-40VB-P
256mm CC	2307-40VB-P
160mm CC	2305-40VB-P
128mm CC	2303-40VB-P
96mm CC	2098-40VB-P
Knob	2311-10VB-P

CC	PRODUCT TYPE	LENGTH	WIDTH	HEIGHT/ PROJECTION	HAND CLEARANCE	DIAMETER	BASE	TAP/SCREWS (QTY)
*448mm	Appliance Pull	19 1/4in.	2 5/32in.	1 1/4in.	3 1/32in.	-	1 7/32in.	10-24 x 1in. (2)
*320mm	Pull	14 3/16in.	1 1/16in.	1 3/8in.	5 7/64in.	-	1/2in.	8-32 x 1in. (2)
256mm	Pull	11 1 1/16in.	1 1/16in.	1 3/8in.	5 7/64in.	-	1/2in.	8-32 x 1in. (2)
160mm	Pull	7 7/8in.	1 1/16in.	1 3/8in.	5 7/64in.	-	1/2in.	8-32 x 1in. (2)
128mm	Pull	6 5/8in.	1 1/16in.	1 3/8in.	5 7/64in.	-	1/2in.	8-32 x 1in. (2)
96mm	Pull	5 7/16in.	1 1/16in.	1 3/8in.	5 7/64in.	-	1/2in.	8-32 x 1in. (2)
-	Knob	1 3/4in.	1 1/16in.	1 1/4in.	2 7/32in.	-	1/2in.	8-32 x 1in. (1)

*Product not shown, please visit BerensonHardware.com to view images and details.

Collection Material: Aluminum



Oasis

FEATURED IN BRUSHED TIN

View display board on p. 134



CC	PRODUCT TYPE	LENGTH	WIDTH	HEIGHT/ PROJECTION	HAND CLEARANCE	DIAMETER	BASE	TAP/SCREWS (QTY)
160mm	Pull	7 5/16in.	1 3/16in.	1 1/16in.	6 1/64in.	-	1 1/16in.	8-32 x 1in. (2)
128mm	Pull	6 1/16in.	1 3/16in.	1 1/16in.	6 1/64in.	-	1 1/16in.	8-32 x 1in. (2)
96mm	Pull	4 7/8in.	1 3/16in.	1 1/16in.	6 1/64in.	-	1 1/16in.	8-32 x 1in. (2)
-	Knob	-	-	1 1/16in.	-	1 1/4in.	5/16in.	8-32 x 1in. (1)

*Product not shown, please visit BerensonHardware.com to view images and details.

Collection Material: Zinc

OASIS AVAILABLE FINISHES, SIZES & PART NUMBERS

Handle Underside: Flat

+2 Additional 8-32 x 1 3/4in. break-off screws provided for pull. 1 Additional 8-32 x 1 3/4in. break-off screw provided for knob.



BRUSHED NICKEL

160mm CC	9252-1BPN-P
128mm CC	9249-1BPN-P
96mm CC	9246-1BPN-P
Knob	9255-1BPN-P



BRUSHED TIN

160mm CC	+9253-10BT-P
128mm CC	9250-10BT-P
96mm CC	9247-10BT-P
Knob	+9256-10BT-P



OIL RUBBED BRONZE

160mm CC	9251-1ORB-P
128mm CC	9248-1ORB-P
96mm CC	9245-1ORB-P
Knob	9254-1ORB-P



Rivet Rebel

FEATURED IN BRUSHED NICKEL AND MATTE BLACK

View display board on p. 134



CC	PRODUCT TYPE	LENGTH	WIDTH	HEIGHT/ PROJECTION	HAND CLEARANCE	DIAMETER	BASE	TAP/SCREWS (QTY)
*18in.	Appliance Pull	21 1/32in.	7/16in.	2 5/32in.	2 3/32in.	-	9/16in.	10-24 x 1in. (2)
*12in.	Appliance Pull	14 3/16in.	23/32in.	1 7/16in.	1 3/16in.	-	1 5/32in.	10-24 x 1in. (2)
224mm	Pull	11 3/16in.	23/32in.	1 7/16in.	1 3/16in.	-	1 5/32in.	8-32 x 1in. (2)
160mm	Pull	8 2/32in.	23/32in.	1 7/16in.	1 3/16in.	-	1 5/32in.	8-32 x 1in. (2)
128mm	Pull	7 1/32in.	23/32in.	1 7/16in.	1 3/16in.	-	1 5/32in.	8-32 x 1in. (2)
96mm	Pull	6 5/32in.	23/32in.	1 7/16in.	1 3/16in.	-	1 5/32in.	8-32 x 1in. (2)
-	Knob	2in.	23/32in.	1 7/16in.	1 3/16in.	-	1 5/32in.	8-32 x 1in. (1)

*Product not shown, please visit BerensonHardware.com to view images and details.

Collection Material: Aluminum
Screw offering subject to change

RIVET REBEL AVAILABLE FINISHES, SIZES & PART NUMBERS

Handle Underside: Flat

BRUSHED NICKEL		BRUSHED NICKEL AND MATTE BLACK		MATTE BLACK	
18in. CC	5133-4BPN-P	18in. CC	Not Available	18in. CC	5134-4055-P
12in. CC	5083-4BPN-P	12in. CC	5125-4BPN55-P	12in. CC	5095-4055-P
224mm CC	5082-4BPN-P	224mm CC	5124-4BPN55-P	224mm CC	5094-4055-P
160mm CC	5081-4BPN-P	160mm CC	5123-4BPN55-P	160mm CC	5093-4055-P
128mm CC	5080-4BPN-P	128mm CC	5122-4BPN55-P	128mm CC	5092-4055-P
96mm CC	5079-4BPN-P	96mm CC	5121-4BPN55-P	96mm CC	5091-4055-P
Knob	5078-4BPN-P	Knob	5120-4BPN55-P	Knob	5090-4055-P

MATTE BLACK AND BRUSHED NICKEL		MATTE BLACK AND MODERN BRUSHED GOLD		MODERN BRUSHED GOLD	
18in. CC	Not Available	18in. CC	5132-455MDB-P	18in. CC	5135-4MDB-P
12in. CC	5119-455BPN-P	12in. CC	5113-455MDB-P	12in. CC	5107-4MDB-P
224mm CC	5118-455BPN-P	224mm CC	5112-455MDB-P	224mm CC	5106-4MDB-P
160mm CC	5117-455BPN-P	160mm CC	5111-455MDB-P	160mm CC	5105-4MDB-P
128mm CC	5116-455BPN-P	128mm CC	5110-455MDB-P	128mm CC	5104-4MDB-P
96mm CC	5115-455BPN-P	96mm CC	5109-455MDB-P	96mm CC	5103-4MDB-P
Knob	5114-455BPN-P	Knob	5108-455MDB-P	Knob	5102-4MDB-P

POLISHED CHROME		SLATE		SLATE AND MATTE BLACK	
18in. CC	Not Available	18in. CC	Not Available	18in. CC	Not Available
12in. CC	5089-4026-P	12in. CC	5101-4SLT-P	12in. CC	5131-4SLT55-P
224mm CC	5088-4026-P	224mm CC	5100-4SLT-P	224mm CC	5130-4SLT55-P
160mm CC	5087-4026-P	160mm CC	5099-4SLT-P	160mm CC	5129-4SLT55-P
128mm CC	5086-4026-P	128mm CC	5098-4SLT-P	128mm CC	5128-4SLT55-P
96mm CC	5085-4026-P	96mm CC	5097-4SLT-P	96mm CC	5127-4SLT55-P
Knob	5084-4026-P	Knob	5096-4SLT-P	Knob	5126-4SLT55-P



Subtle Surge

FEATURED IN MATTE BLACK

View display board on p. 135



224mm CC

160mm CC

128mm CC

96mm CC



Knob
has pin at bottom to help secure in position

SUBTLE SURGE AVAILABLE FINISHES, SIZES & PART NUMBERS

Handle Underside: Flat



BRUSHED NICKEL

18in. CC	1115-1BPN-P
12in. CC	1266-1BPN-P
224mm CC	1260-1BPN-P
160mm CC	1254-1BPN-P
128mm CC	1248-1BPN-P
96mm CC	1242-1BPN-P
Knob	1236-1BPN-P



MATTE BLACK

18in. CC	1119-1055-P
12in. CC	1269-1055-P
224mm CC	1263-1055-P
160mm CC	1257-1055-P
128mm CC	1251-1055-P
96mm CC	1245-1055-P
Knob	1239-1055-P



MODERN BRUSHED GOLD

18in. CC	1114-1MDB-P
12in. CC	1270-1MDB-P
224mm CC	1264-1MDB-P
160mm CC	1258-1MDB-P
128mm CC	1252-1MDB-P
96mm CC	1246-1MDB-P
Knob	1240-1MDB-P



POLISHED NICKEL

18in. CC	1116-1014-P
12in. CC	1268-1014-P
224mm CC	1262-1014-P
160mm CC	1256-1014-P
128mm CC	1250-1014-P
96mm CC	1244-1014-P
Knob	1238-1014-P



VERONA BRONZE

18in. CC	1117-10VB-P
12in. CC	1267-10VB-P
224mm CC	1261-10VB-P
160mm CC	1255-10VB-P
128mm CC	1249-10VB-P
96mm CC	1243-10VB-P
Knob	1237-10VB-P



VINTAGE NICKEL

18in. CC	1118-1VTN-P
12in. CC	1271-1VTN-P
224mm CC	1265-1VTN-P
160mm CC	1259-1VTN-P
128mm CC	1253-1VTN-P
96mm CC	1247-1VTN-P
Knob	1241-1VTN-P

CC	PRODUCT TYPE	LENGTH	WIDTH	HEIGHT/ PROJECTION	HAND CLEARANCE	DIAMETER	BASE	TAP/SCREWS (QTY)
*18in.	Appliance Pull	18 7/16in.	2 3/32in.	2 3/32in.	1 3/16in.	-	1 1/32in.	10-24 x 1in. (2)
*12in.	Appliance Pull	12 5/16in.	1 1/16in.	1 5/16in.	1 1/16in.	-	5/16in.	10-24 x 1in. (2)
224mm	Pull	9 3/8in.	1/2in.	1 3/8in.	6 1/4in.	-	7/16in.	8-32 x 1in. (2)
160mm	Pull	6 1 5/16in.	1 3/32in.	1 3/8in.	6 1/4in.	-	1 3/32in.	8-32 x 1in. (2)
128mm	Pull	5 5/16in.	7/16in.	1 3/8in.	6 1/4in.	-	3/8in.	8-32 x 1in. (2)
96mm	Pull	4 3/8in.	7/16in.	1 5/16in.	1 5/16in.	-	3/8in.	8-32 x 1in. (2)
-	Knob	1 5/16in.	3/4in.	1 1/4in.	2 3/32in.	-	1/2in.	8-32 x 1in. (1)

*Product not shown, please visit BerensonHardware.com to view images and details.

Collection Material: Zinc



Tempo

FEATURED IN BRUSHED NICKEL

View display board on p. 135

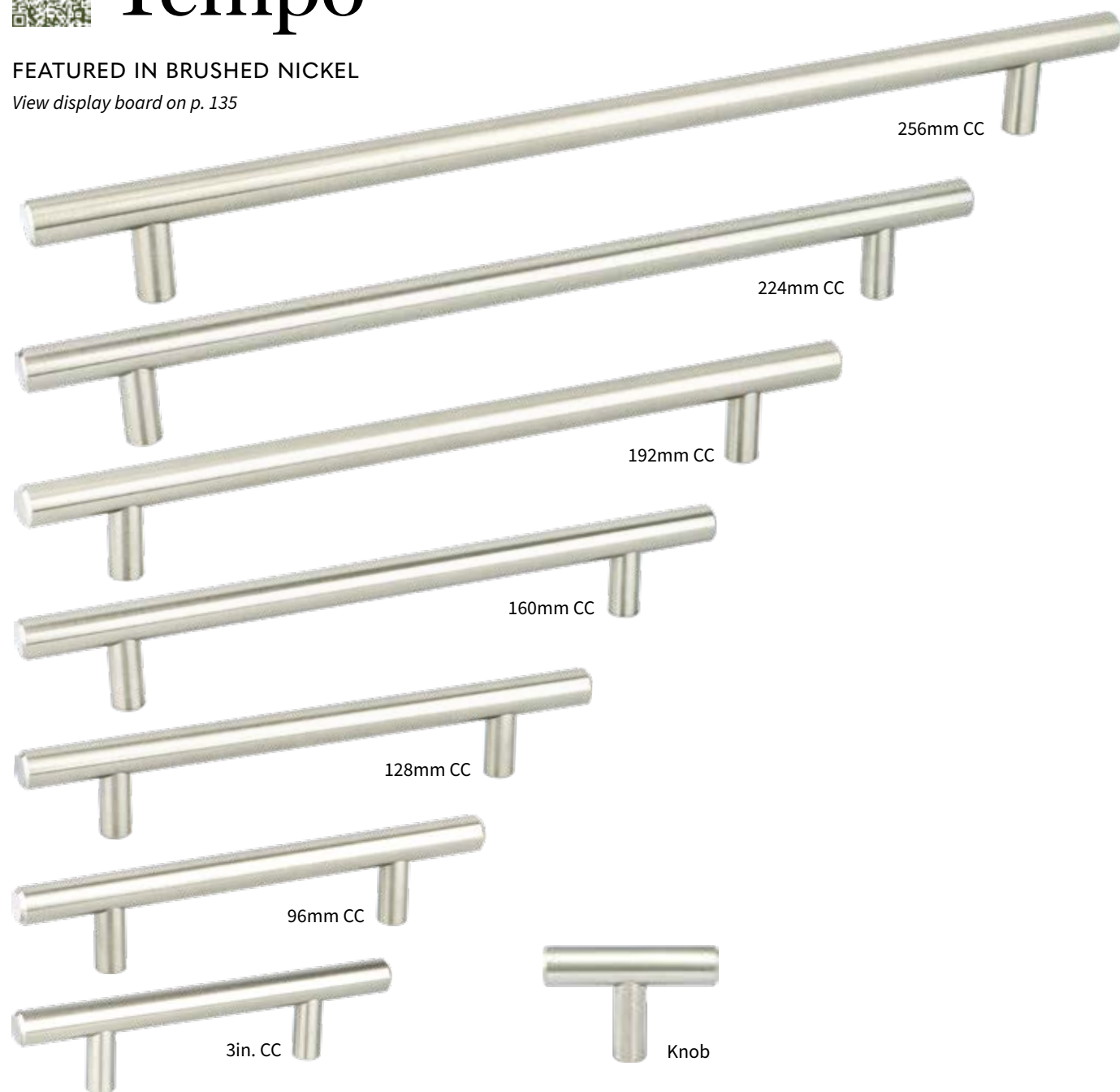

CC	PRODUCT TYPE	LENGTH	WIDTH	HEIGHT/ PROJECTION	HAND CLEARANCE	DIAMETER	BASE	TAP/SCREWS (QTY)
*320mm	Pull	15in.	½in.	1 ¼in.	2 ⁵ / ₃₂ in.	-	¾in.	8-32 x 1in. (2)
256mm	Pull	12 ⅞in.	½in.	1 ¼in.	2 ⁵ / ₃₂ in.	-	¾in.	8-32 x 1in. (2)
224mm	Pull	11 ¾in.	½in.	1 ¼in.	2 ⁵ / ₃₂ in.	-	¾in.	8-32 x 1in. (2)
192mm	Pull	9 1 ⁵ / ₁₆ in.	½in.	1 ¼in.	2 ⁵ / ₃₂ in.	-	¾in.	8-32 x 1in. (2)
160mm	Pull	8 1 ¹ / ₁₆ in.	½in.	1 ¼in.	2 ⁵ / ₃₂ in.	-	¾in.	8-32 x 1in. (2)
128mm	Pull	7 ¾in.	½in.	1 ¼in.	2 ⁵ / ₃₂ in.	-	¾in.	8-32 x 1in. (2)
96mm	Pull	6 ⅞in.	½in.	1 ¼in.	2 ⁵ / ₃₂ in.	-	¾in.	8-32 x 1in. (2)
3in.	Pull	5 ⅝in.	½in.	1 ¼in.	2 ⁵ / ₃₂ in.	-	¾in.	8-32 x 1in. (2)
-	Knob	2in.	½in.	1 ¼in.	2 ⁵ / ₃₂ in.	-	¾in.	8-32 x 1in. (1)

*Product not shown, please visit BerensonHardware.com to view images and details.

Collection Material: Steel

TEMPO AVAILABLE FINISHES, SIZES & PART NUMBERS

Handle Underside: Curved

BLACK		BRUSHED NICKEL		MODERN BRUSHED GOLD	
320mm CC	0838-2055-P	320mm CC	0810-2BPN-P	320mm CC	0828-2MDB-P
256mm CC	0836-2055-P	256mm CC	0808-2BPN-P	256mm CC	0826-2MDB-P
224mm CC	0835-2055-P	224mm CC	1127-2BPN-P	224mm CC	0825-2MDB-P
192mm CC	0834-2055-P	192mm CC	0806-2BPN-P	192mm CC	0824-2MDB-P
160mm CC	0833-2055-P	160mm CC	1126-2BPN-P	160mm CC	0823-2MDB-P
128mm CC	0832-2055-P	128mm CC	0804-2BPN-P	128mm CC	0822-2MDB-P
96mm CC	0831-2055-P	96mm CC	0802-2BPN-P	96mm CC	0821-2MDB-P
3in. CC	0830-2055-P	3in. CC	0800-2BPN-P	3in. CC	0820-2MDB-P
Knob	0839-2055-P	Knob	2020-2BPN-P	Knob	0829-2MDB-P

POLISHED CHROME		VERONA BRONZE	
320mm CC	2006-2026-P	320mm CC	0811-20VB-P
256mm CC	2017-2026-P	256mm CC	0809-20VB-P
224mm CC	2016-2026-P	224mm CC	0813-20VB-P
192mm CC	2015-2026-P	192mm CC	0807-20VB-P
160mm CC	2028-2026-P	160mm CC	0812-20VB-P
128mm CC	2014-2026-P	128mm CC	0805-20VB-P
96mm CC	2013-2026-P	96mm CC	0803-20VB-P
3in. CC	2012-2026-P	3in. CC	0801-20VB-P
Knob	2019-2026-P	Knob	2018-20VB-P

TEMPO LONGER LENGTHS ON NEXT PAGE

Available in Brushed Nickel

TEMPO LONGER LENGTHS | ONLY AVAILABLE IN BRUSHED NICKEL

Handle Underside: Curved

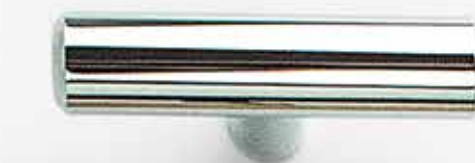
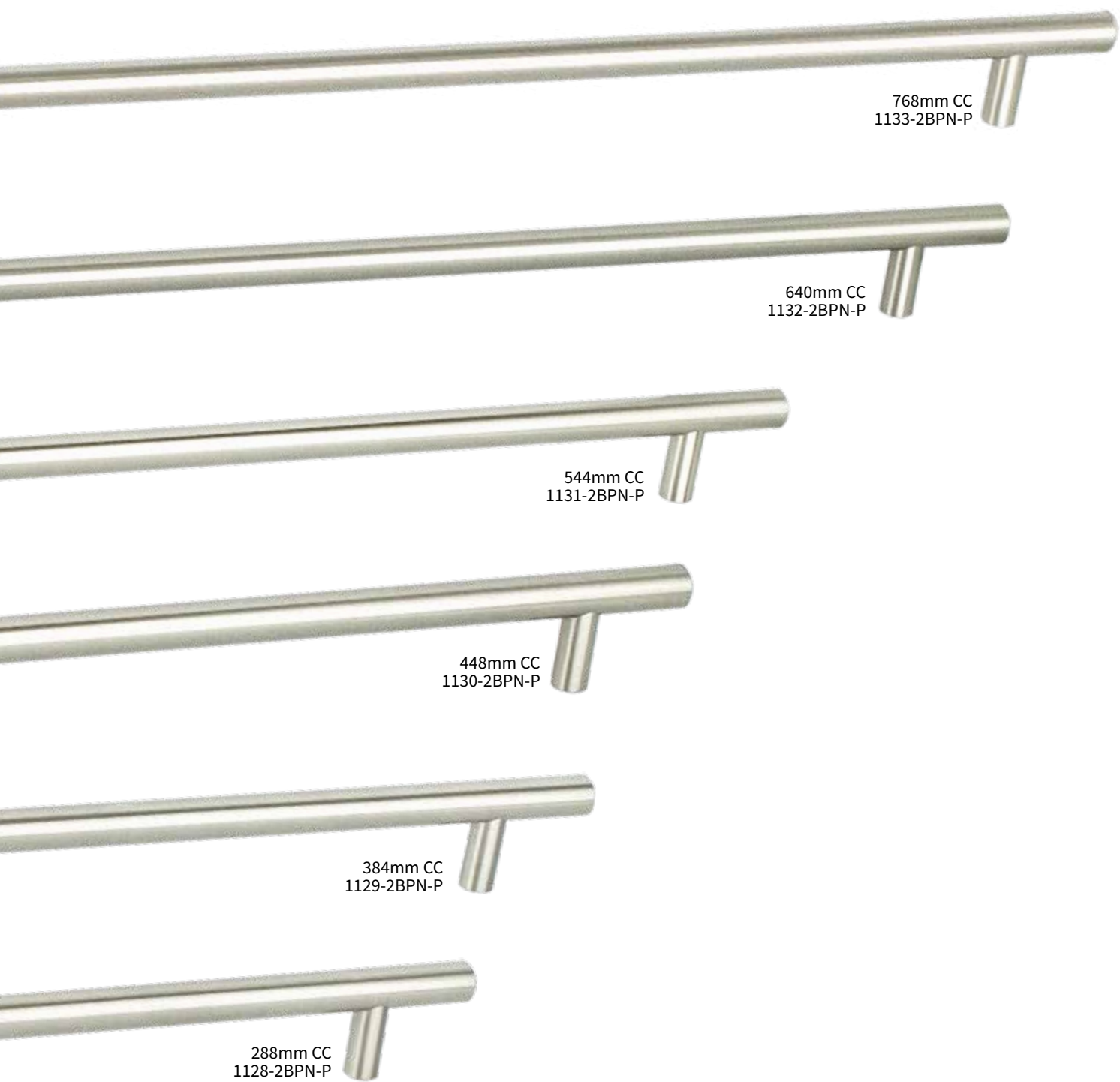

CC	PRODUCT TYPE	LENGTH	WIDTH	HEIGHT/ PROJECTION	HAND CLEARANCE	DIAMETER	BASE	TAP/SCREWS (QTY)
768mm	Pull	32 5/8in.	1/2in.	1 1/4in.	2 5/8in.	-	3/8in.	8-32 x 1in. (2)
640mm	Pull	27 1/8in.	1/2in.	1 1/4in.	2 5/8in.	-	3/8in.	8-32 x 1in. (2)
544mm	Pull	23 3/4in.	1/2in.	1 1/4in.	2 5/8in.	-	3/8in.	8-32 x 1in. (2)
448mm	Pull	20in.	1/2in.	1 1/4in.	2 5/8in.	-	3/8in.	8-32 x 1in. (2)
384mm	Pull	17 1/2in.	1/2in.	1 1/4in.	2 5/8in.	-	3/8in.	8-32 x 1in. (2)
288mm	Pull	13 1/8in.	1/2in.	1 1/4in.	2 5/8in.	-	3/8in.	8-32 x 1in. (2)

*Product not shown, please visit BerensonHardware.com to view images and details.

Collection Material: Steel



Appliance Pulls

Shown to Scale

ASPIRE

12in. & 18in. Appliance Pull



Appliance pulls add a cohesive look to your design with applications across your entire home. Designed for heavier use, they can be used on tall pantry doors, wide drawers and built-in appliances due to their secure 10-24 tap.

AVAILABLE FINISHES *Featured in Brushed Copper*

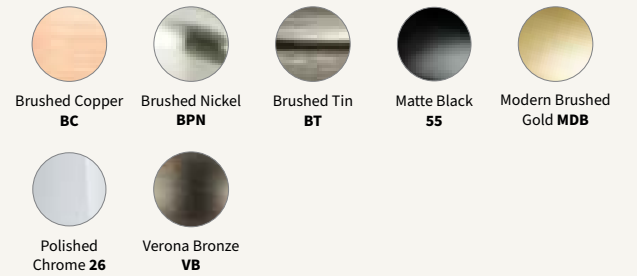

Not all finishes available in both lengths.

BROOKRIDGE

12in. & 18in. Appliance Pull



AVAILABLE FINISHES *Featured in Matte Black*



Not all finishes available in both lengths.

CANNELEE

12in. Appliance Pull



AVAILABLE FINISHES *Featured in Modern Brushed Gold*

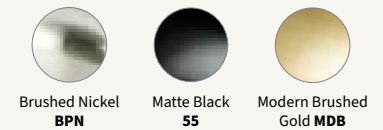



Appliance Pulls

Shown to Scale

DESIGNERS' GROUP TEN

12in. & 18in. Appliance Pull



DIERDRA

12in. Appliance Pull



DOMESTIC BLISS

18in. Appliance Pull



Appliance pulls add a cohesive look to your design with applications across your entire home. Designed for heavier use, they can be used on tall pantry doors, wide drawers and built-in appliances due to their secure 10-24 tap.

AVAILABLE FINISHES *Featured in Polished Nickel*



Polished Nickel
14

AVAILABLE FINISHES *Featured in Toasted Bronze*



Brushed Nickel
BPN



Matte Black
55



Modern Brushed Gold
MDB



Polished Nickel
14



Toasted Bronze
TB



Vintage Nickel
VTN

AVAILABLE FINISHES *Featured in Matte Black*



Brushed Nickel
BPN



Matte Black
55



Modern Brushed Gold
MDB

Appliance Pulls

Shown to Scale

MEADOW

448mm Appliance Pull



AVAILABLE FINISHES *Featured in Polished Chrome*



RIVET REBEL

12in. & 18in. Appliance Pull



AVAILABLE FINISHES *Featured in Matte Black & Brushed Nickel*

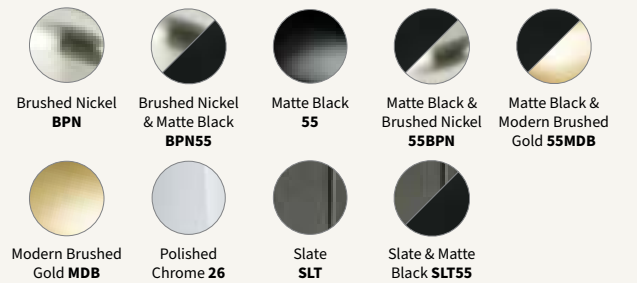

Not all finishes available in both lengths.

SUBTLE SURGE

12in. & 18in. Appliance Pull



AVAILABLE FINISHES *Featured in Modern Brushed Gold*





Galloway
in Modern Brushed Gold
paired with
Dierdra
in Modern Brushed Gold

Radial Reign
in Matte Black and
Modern Brushed Gold

CONTEMPORARY STYLE

Uptown Appeal

Favor clean lines and subtle flair in minimalist hardware designs for a sleek approach to home design.





FEATURED IN SATIN BLACK
View display board on p. 136



**ALUMINUM
EDGE PULL ALSO
AVAILABLE
(1051-4ALU-B)***



*Pull measures 96 7/8in. long and is made for you to cut down to your required size.

CC	PRODUCT TYPE	LENGTH	WIDTH	HEIGHT/ PROJECTION	HAND CLEARANCE	DIAMETER	BASE	TAP/SCREWS (QTY)
169mm	Edge Pull	9 1/8in.	3/4in.	1 3/4in.	-	-	1 1/2in.	3/8in. Wood (2)
112mm	Edge Pull	6in.	3/4in.	1 3/4in.	-	-	1 1/2in.	3/8in. Wood (2)
56mm	Edge Pull	3in.	3/4in.	1 3/4in.	-	-	1 1/2in.	3/8in. Wood (2)
32mm	Edge Pull	1 3/4in.	3/4in.	1 3/4in.	-	-	1 1/2in.	3/8in. Wood (2)

Collection Material: Aluminum

BRAVO AVAILABLE FINISHES, SIZES & PART NUMBERS



BRUSHED COPPER

169mm	1049-40BC-P
112mm	1048-40BC-P
56mm	1047-40BC-P
32mm	1046-40BC-P



BRUSHED NICKEL

169mm	1065-4BPN-P
112mm	1061-4BPN-P
56mm	1057-4BPN-P
32mm	1052-4BPN-P



GRAPHITE

169mm	1076-4GPH-P
112mm	1075-4GPH-P
56mm	1074-4GPH-P
32mm	1073-4GPH-P



POLISHED CHROME

169mm	1066-4026-P
112mm	1062-4026-P
56mm	1058-4026-P
32mm	1053-4026-P



SATIN BLACK

169mm	1068-4055-P
112mm	1064-4055-P
56mm	1060-4055-P
32mm	1056-4055-P



SATIN GOLD

169mm	1072-40SG-P
112mm	1071-40SG-P
56mm	1070-40SG-P
32mm	1069-40SG-P



VERONA BRONZE

169mm	1067-40VB-P
112mm	1063-40VB-P
56mm	1059-40VB-P
32mm	1055-40VB-P

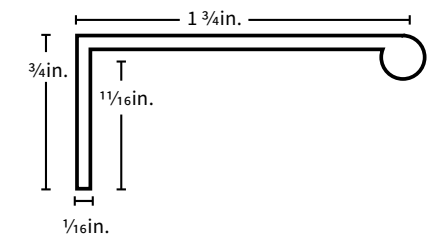



FEATURED IN VERONA BRONZE
View display board on p. 136



CC	PRODUCT TYPE	LENGTH	WIDTH	HEIGHT/ PROJECTION	HAND CLEARANCE	DIAMETER	BASE	TAP/SCREWS (QTY)
*18in.	Appliance Pull	19 5/16in.	1 3/16in.	2in.	1 3/8in.	-	1 3/16in.	10-24 x 1in. (2)
*320mm	Appliance Pull	13 1/8in.	3/4in.	1 1/2in.	5/16in.	-	9/16in.	10-24 x 1in. (2)
256mm	Pull	10 5/8in.	3/4in.	1 1/2in.	5/16in.	-	9/16in.	8-32 x 1in. (2)
160mm	Pull	6 1 3/8in.	3/4in.	1 1/2in.	5/16in.	-	9/16in.	8-32 x 1in. (2)
128mm	Pull	5 5/8in.	3/4in.	1 1/2in.	5/16in.	-	9/16in.	8-32 x 1in. (2)
96mm	Pull	4 5/8in.	3/4in.	1 1/2in.	5/16in.	-	9/16in.	8-32 x 1in. (2)
-	① Knob	1 9/16in.	1 9/16in.	1 1/2in.	3 3/4in.	-	1 5/16in.	8-32 x 1in. (1)
-	② Knob	1 3/8in.	1 3/8in.	7/8in.	1 9/32in.	-	1 9/32in.	8-32 x 1in. (1)

*Product not shown, please visit BerensonHardware.com to view images and details.

Collection Material: Aluminum
Knob ② Material: Zinc

ELEVATE AVAILABLE FINISHES, SIZES & PART NUMBERS

Handle Underside: Curved

BRUSHED NICKEL		GRAPHITE		MATTE BLACK	
18in. CC	2101-4BPN-P	18in. CC	2114-4GPH-P	18in. CC	2121-4055-P
320mm CC	2093-4BPN-P	320mm CC	2113-4GPH-P	320mm CC	2120-4055-P
256mm CC	2091-4BPN-P	256mm CC	2112-4GPH-P	256mm CC	2119-4055-P
160mm CC	2089-4BPN-P	160mm CC	2111-4GPH-P	160mm CC	2118-4055-P
128mm CC	2087-4BPN-P	128mm CC	2110-4GPH-P	128mm CC	2117-4055-P
96mm CC	2085-4BPN-P	96mm CC	2109-4GPH-P	96mm CC	2116-4055-P
① Knob	2095-4BPN-P	① Knob	2115-4GPH-P	① Knob	2122-4055-P
② Knob	2172-1BPN-P	② Knob	2174-1GPH-P	② Knob	2175-1055-P

POLISHED CHROME		SATIN GOLD		VERONA BRONZE	
18in. CC	2128-4026-P	18in. CC	2107-40SG-P	18in. CC	2100-40VB-P
320mm CC	2127-4026-P	320mm CC	2106-40SG-P	320mm CC	2094-40VB-P
256mm CC	2126-4026-P	256mm CC	2105-40SG-P	256mm CC	2092-40VB-P
160mm CC	2125-4026-P	160mm CC	2104-40SG-P	160mm CC	2090-40VB-P
128mm CC	2124-4026-P	128mm CC	2103-40SG-P	128mm CC	2088-40VB-P
96mm CC	2123-4026-P	96mm CC	2102-40SG-P	96mm CC	2086-40VB-P
① Knob	2129-4026-P	① Knob	2108-40SG-P	① Knob	2096-40VB-P
② Knob	2176-1026-P	② Knob	2173-10SG-P	② Knob	2177-10VB-P

Epoch Edge

FEATURED IN MODERN BRUSHED GOLD

View display board on p. 136

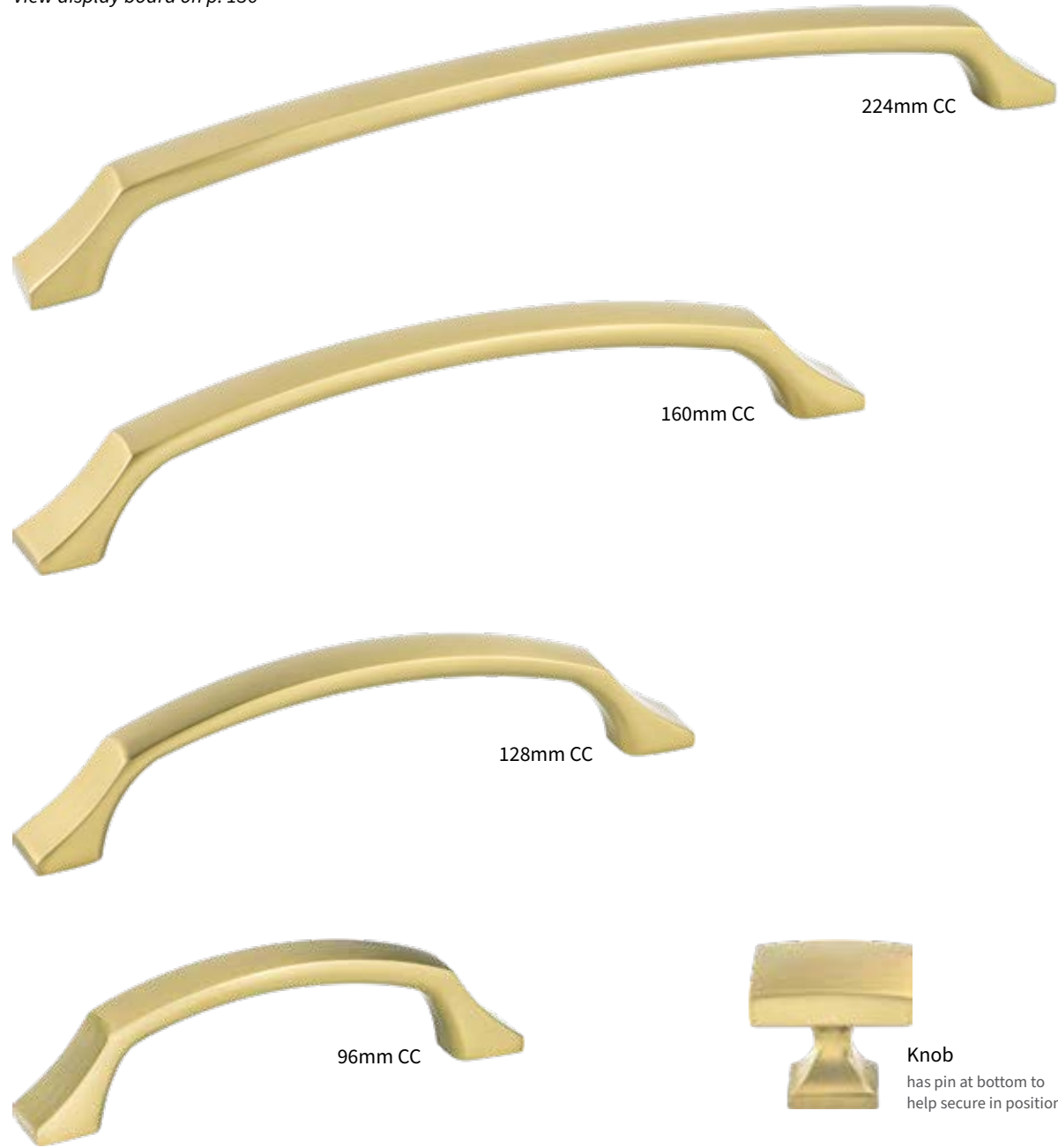

EPOCH EDGE AVAILABLE FINISHES, SIZES & PART NUMBERS

Handle Underside: Semi-Curved



BRUSHED NICKEL

12in. CC	1230-1BPN-P
224mm CC	1224-1BPN-P
160mm CC	1218-1BPN-P
128mm CC	1212-1BPN-P
96mm CC	1206-1BPN-P
Knob	1200-1BPN-P



MATTE BLACK

12in. CC	1233-1055-P
224mm CC	1227-1055-P
160mm CC	1221-1055-P
128mm CC	1215-1055-P
96mm CC	1209-1055-P
Knob	1203-1055-P



MODERN BRUSHED GOLD

12in. CC	1234-1MDB-P
224mm CC	1228-1MDB-P
160mm CC	1222-1MDB-P
128mm CC	1216-1MDB-P
96mm CC	1210-1MDB-P
Knob	1204-1MDB-P



POLISHED CHROME

12in. CC	1232-1026-P
224mm CC	1226-1026-P
160mm CC	1220-1026-P
128mm CC	1214-1026-P
96mm CC	1208-1026-P
Knob	1202-1026-P



VERONA BRONZE

12in. CC	1231-10VB-P
224mm CC	1225-10VB-P
160mm CC	1219-10VB-P
128mm CC	1213-10VB-P
96mm CC	1207-10VB-P
Knob	1201-10VB-P



VINTAGE NICKEL

12in. CC	1235-1VTN-P
224mm CC	1229-1VTN-P
160mm CC	1223-1VTN-P
128mm CC	1217-1VTN-P
96mm CC	1211-1VTN-P
Knob	1205-1VTN-P



Knob
has pin at bottom to help secure in position

CC	PRODUCT TYPE	LENGTH	WIDTH	HEIGHT/ PROJECTION	HAND CLEARANCE	DIAMETER	BASE	TAP/SCREWS (QTY)
*12in.	Appliance Pull	12 7/8in.	7/8in.	1 1/16in.	1 3/32in.	-	1in.	10-24 x 1in. (2)
224mm	Pull	9 1/2in.	1 1/16in.	1 3/8in.	1 3/64in.	-	1 1/16in.	8-32 x 1in. (2)
160mm	Pull	7 1/8in.	5/8in.	1 5/16in.	1 1/32in.	-	5/8in.	8-32 x 1in. (2)
128mm	Pull	5 1 3/16in.	5/8in.	1 5/16in.	1 1/32in.	-	5/8in.	8-32 x 1in. (2)
96mm	Pull	4 7/16in.	5/8in.	1 3/8in.	2 9/32in.	-	5/8in.	8-32 x 1in. (2)
-	Knob	1 3/8in.	1 1/8in.	1 1/4in.	7/8in.	-	5/8in.	8-32 x 1in. (1)

*Product not shown, please visit BerensonHardware.com to view images and details.

Collection Material: Zinc



Fluidic

FEATURED IN BRUSHED NICKEL

View display board on p. 136



128mm CC



96mm CC



Knob
has pin at bottom to help secure in position

FLUIDIC AVAILABLE FINISHES, SIZES & PART NUMBERS

Handle Underside: Flat



BLACK



BRUSHED NICKEL



POLISHED CHROME

128mm CC	9440-1055-P
96mm CC	9439-1055-P
Knob	9441-1055-P

128mm CC	9478-1BPN-P
96mm CC	9476-1BPN-P
Knob	9480-1BPN-P

128mm CC	9477-1026-P
96mm CC	9475-1026-P
Knob	9479-1026-P

CC	PRODUCT TYPE	LENGTH	WIDTH	HEIGHT/ PROJECTION	HAND CLEARANCE	DIAMETER	BASE	TAP/SCREWS (QTY)
128mm	Pull	6 1/4in.	1 3/8in.	1 3/8in.	1 1/2in.	-	7/16in.	8-32 x 1in. (2)
96mm	Pull	4 1 1/4in.	1 3/8in.	1 3/8in.	6 1/4in.	-	7/16in.	8-32 x 1in. (2)
-	Knob	1 3/8in.	1 1/8in.	1 1/8in.	-	-	1 1/8in.	8-32 x 1in. (1)

*Product not shown, please visit BerensonHardware.com to view images and details.

Collection Material: Zinc





Laura

FEATURED IN MODERN BRUSHED GOLD

View display board on p. 136

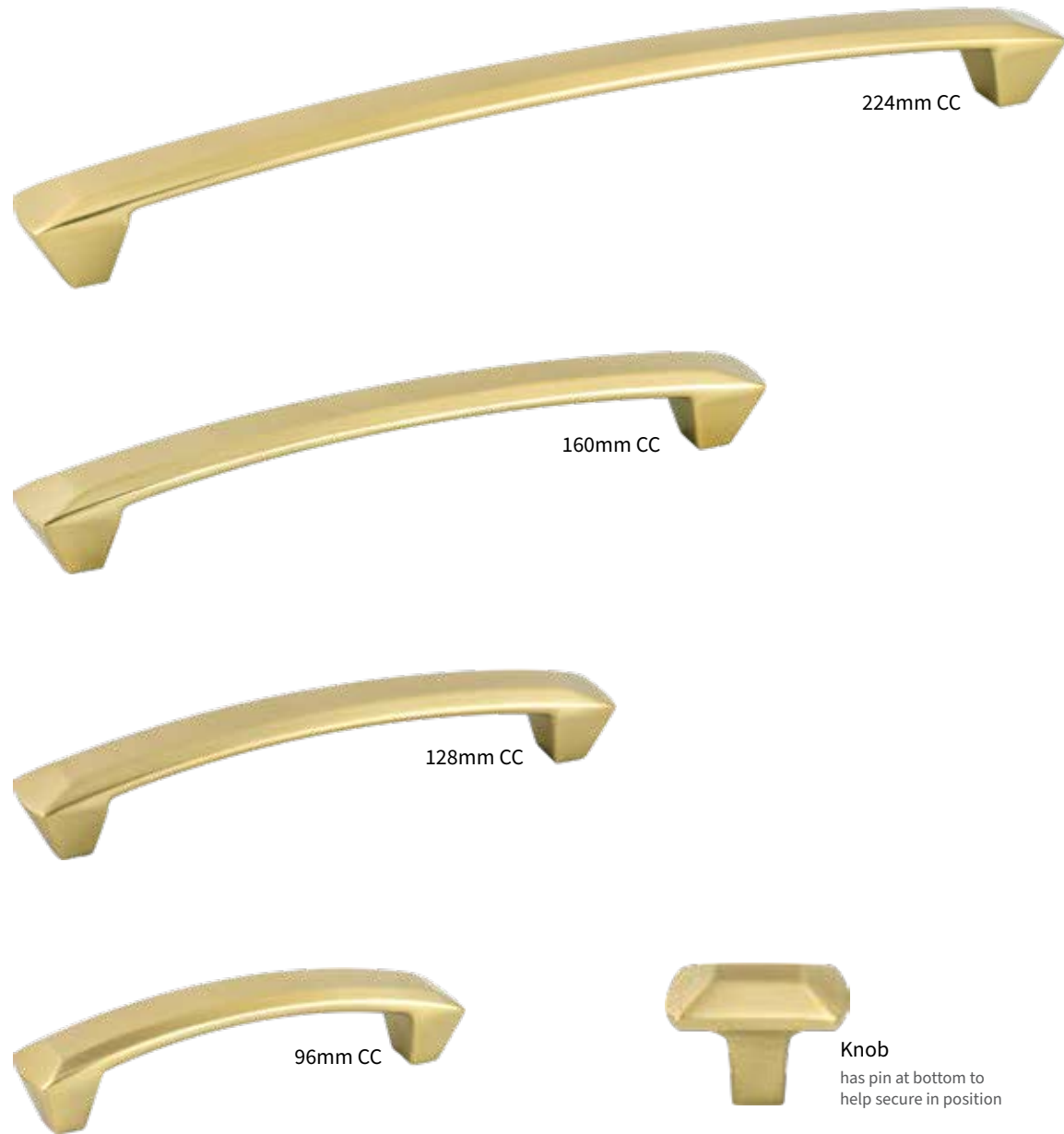

224mm CC

160mm CC

128mm CC

96mm CC

Knob
has pin at bottom to help secure in position

LAURA AVAILABLE FINISHES, SIZES & PART NUMBERS

Handle Underside: Flat



BRUSHED NICKEL

12in. CC	4193-1BPN-P
224mm CC	9813-1BPN-P
160mm CC	9812-1BPN-P
128mm CC	4077-1BPN-P
96mm CC	4072-1BPN-P
Knob	4088-1BPN-P



MATTE BLACK

12in. CC	4212-1055-P
224mm CC	4211-1055-P
160mm CC	4210-1055-P
128mm CC	4209-1055-P
96mm CC	4208-1055-P
Knob	4207-1055-P



MODERN BRUSHED GOLD

12in. CC	4194-1MDB-P
224mm CC	9817-1MDB-P
160mm CC	9816-1MDB-P
128mm CC	9815-1MDB-P
96mm CC	9814-1MDB-P
Knob	9818-1MDB-P



POLISHED CHROME

12in. CC	4195-1026-P
224mm CC	9820-1026-P
160mm CC	9819-1026-P
128mm CC	4087-1026-P
96mm CC	4084-1026-P
Knob	4090-1026-P



VINTAGE NICKEL

12in. CC	4196-1VTN-P
224mm CC	9824-1VTN-P
160mm CC	9823-1VTN-P
128mm CC	9822-1VTN-P
96mm CC	9821-1VTN-P
Knob	9827-1VTN-P

CC	PRODUCT TYPE	LENGTH	WIDTH	HEIGHT/ PROJECTION	HAND CLEARANCE	DIAMETER	BASE	TAP/SCREWS (QTY)
*12in.	Appliance Pull	13 5/32in.	1 1/2in.	1 17/32in.	1 1/4in.	-	5/16in.	10-24 x 1in. (2)
224mm	Pull	9 3/4in.	1 3/16in.	1 3/16in.	55/64in.	-	5/16in.	8-32 x 1in. (2)
160mm	Pull	7 1/4in.	1 3/16in.	1 1/16in.	29/32in.	-	5/16in.	8-32 x 1in. (2)
128mm	Pull	6in.	7/8in.	1in.	7/8in.	-	5/16in.	8-32 x 1in. (2)
96mm	Pull	4 7/16in.	7/8in.	1in.	53/64in.	-	5/16in.	8-32 x 1in. (2)
-	Knob	1 7/16in.	1in.	1in.	5/8in.	-	7/16in.	8-32 x 1in. (1)

*Product not shown, please visit BerensonHardware.com to view images and details.

Collection Material: Zinc



Skyline
in Modern Brushed Gold



Metro
in Modern Brushed Gold

Metro

FEATURED IN MATTE BLACK

View display board on p. 136



224mm CC

160mm CC

128mm CC

96mm CC



Knob
has pin at bottom to help secure in position

CC	PRODUCT TYPE	LENGTH	WIDTH	HEIGHT/ PROJECTION	HAND CLEARANCE	DIAMETER	BASE	TAP/SCREWS (QTY)
*18in.	Appliance Pull	18 1/4in.	1 1/16in.	2 3/32in.	1 29/64in.	-	23/32in.	10-24 x 1in. (2)
*320mm	Pull	13in.	7/16in.	1 3/16in.	57/64in.	-	3/16in.	8-32 x 1in. (2)
224mm	Pull	9 1/4in.	7/16in.	1 3/16in.	57/64in.	-	3/16in.	8-32 x 1in. (2)
160mm	Pull	6 1/16in.	7/16in.	1 3/16in.	29/32in.	-	3/16in.	8-32 x 1in. (2)
128mm	Pull	5 7/16in.	7/16in.	1 3/16in.	29/32in.	-	3/16in.	8-32 x 1in. (2)
96mm	Pull	4 3/16in.	7/16in.	1 3/16in.	29/32in.	-	3/16in.	8-32 x 1in. (2)
-	Knob	1 3/16in.	1 3/16in.	1 1/4in.	3 1/2in.	-	5/16in.	8-32 x 1in. (1)

*Product not shown, please visit BerensonHardware.com to view images and details.

Collection Material: Zinc

METRO AVAILABLE FINISHES, SIZES & PART NUMBERS

Handle Underside: Curved

+2 Additional 8-32 x 1 3/4in. break-off screws provided for pulls. 1 Additional 8-32 x 1 3/4in. break-off screw provided for knob.



BRUSHED NICKEL

18in. CC	9860-1BPN-P
320mm CC	9857-1BPN-P
224mm CC	9828-1BPN-P
160mm CC	4118-1BPN-P
128mm CC	4113-1BPN-P
96mm CC	4108-1BPN-P
Knob	4122-1BPN-P



MATTE BLACK

18in. CC	9861-1055-P
320mm CC	9859-1055-P
224mm CC	9858-1055-P
160mm CC	+4121-1055-P
128mm CC	4116-1055-P
96mm CC	+4111-1055-P
Knob	+4126-1055-P



MODERN BRUSHED GOLD

18in. CC	9912-1MDB-P
320mm CC	9902-1MDB-P
224mm CC	9901-1MDB-P
160mm CC	9899-1MDB-P
128mm CC	9898-1MDB-P
96mm CC	9897-1MDB-P
Knob	9903-1MDB-P



POLISHED CHROME

18in. CC	9916-1026-P
320mm CC	9905-1026-P
224mm CC	9904-1026-P
160mm CC	4119-1026-P
128mm CC	4114-1026-P
96mm CC	4109-1026-P
Knob	4124-1026-P



POLISHED COPPER

18in. CC	Not Available
320mm CC	4184-10PC-P
224mm CC	4183-10PC-P
160mm CC	4182-10PC-P
128mm CC	4181-10PC-P
96mm CC	4180-10PC-P
Knob	4185-10PC-P



SLATE

18in. CC	9973-1SLT-P
320mm CC	9970-1SLT-P
224mm CC	9909-1SLT-P
160mm CC	9908-1SLT-P
128mm CC	9907-1SLT-P
96mm CC	9906-1SLT-P
Knob	9971-1SLT-P



TOASTED BRONZE

18in. CC	Not Available
320mm CC	4190-10TB-P
224mm CC	4189-10TB-P
160mm CC	4188-10TB-P
128mm CC	4187-10TB-P
96mm CC	4191-10TB-P
Knob	4192-10TB-P



Radial Reign

FEATURED IN MATTE BLACK AND MODERN BRUSHED GOLD

View display board on p. 137

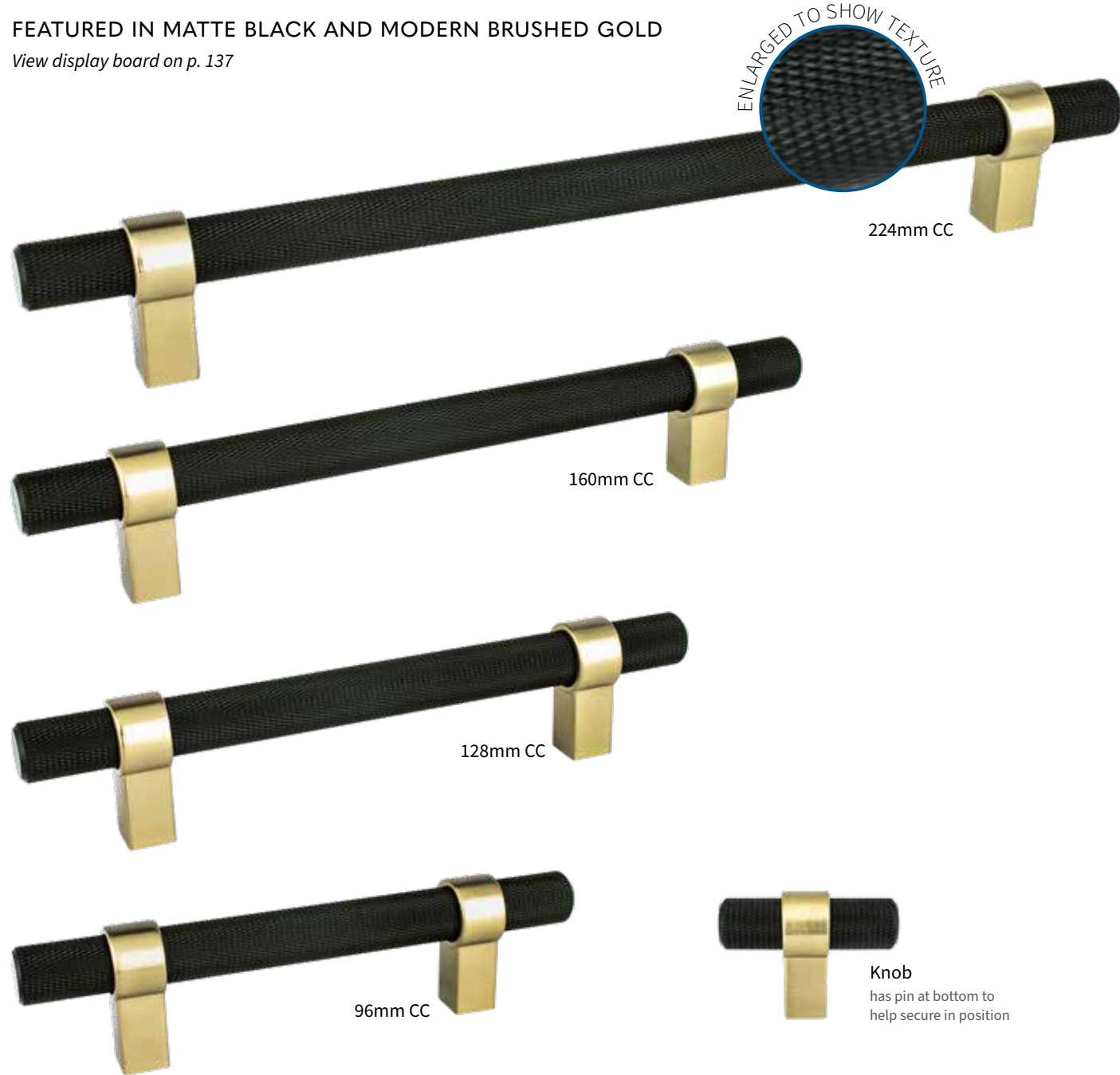

RADIAL REIGN AVAILABLE FINISHES, SIZES & PART NUMBERS

Handle Underside: Curved

BLACK NICKEL		BRUSHED NICKEL		BRUSHED NICKEL AND MATTE BLACK	
18in. CC	Not Available	18in. CC	5136-4BPN-P	18in. CC	Not Available
12in. CC	5077-4098-P	12in. CC	5029-4BPN-P	12in. CC	5071-4BPN55-P
224mm CC	5076-4098-P	224mm CC	5028-4BPN-P	224mm CC	5070-4BPN55-P
160mm CC	5075-4098-P	160mm CC	5027-4BPN-P	160mm CC	5069-4BPN55-P
128mm CC	5074-4098-P	128mm CC	5026-4BPN-P	128mm CC	5068-4BPN55-P
96mm CC	5073-4098-P	96mm CC	5025-4BPN-P	96mm CC	5067-4BPN55-P
Knob	5072-4098-P	Knob	5024-4BPN-P	Knob	5066-4BPN55-P

MATTE BLACK		MATTE BLACK AND BRUSHED NICKEL		MATTE BLACK AND MODERN BRUSHED GOLD	
18in. CC	5137-4055-P	18in. CC	5140-455BPN-P	18in. CC	5138-455MDB-P
12in. CC	5041-4055-P	12in. CC	5065-455BPN-P	12in. CC	5059-455MDB-P
224mm CC	5040-4055-P	224mm CC	5064-455BPN-P	224mm CC	5058-455MDB-P
160mm CC	5039-4055-P	160mm CC	5063-455BPN-P	160mm CC	5057-455MDB-P
128mm CC	5038-4055-P	128mm CC	5062-455BPN-P	128mm CC	5056-455MDB-P
96mm CC	5037-4055-P	96mm CC	5061-455BPN-P	96mm CC	5055-455MDB-P
Knob	5036-4055-P	Knob	5060-455BPN-P	Knob	5054-455MDB-P

CC	PRODUCT TYPE	LENGTH	WIDTH	HEIGHT/ PROJECTION	HAND CLEARANCE	DIAMETER	BASE	TAP/SCREWS (QTY)
*18in.	Appliance Pull	21 1/32in.	1 1/2in.	2 7/32in.	1 3/32in.	-	1 9/32in.	10-24 x 1in. (2)
*12in.	Appliance Pull	14 3/16in.	2 3/32in.	1 7/16in.	1 3/16in.	-	1 9/32in.	10-24 x 1in. (2)
224mm	Pull	11 3/16in.	2 3/32in.	1 7/16in.	1 3/16in.	-	1 9/32in.	8-32 x 1in. (2)
160mm	Pull	8 2 1/32in.	2 3/32in.	1 7/16in.	1 3/16in.	-	1 9/32in.	8-32 x 1in. (2)
128mm	Pull	7 1 3/32in.	2 3/32in.	1 7/16in.	1 3/16in.	-	1 9/32in.	8-32 x 1in. (2)
96mm	Pull	6 5/32in.	2 3/32in.	1 7/16in.	1 3/16in.	-	1 9/32in.	8-32 x 1in. (2)
-	Knob	2in.	2 3/32in.	1 7/16in.	1 3/16in.	-	1 9/32in.	8-32 x 1in. (1)

*Product not shown, please visit BerensonHardware.com to view images and details.

Collection Material: Aluminum
Screws offering subject to change

ADDITIONAL FINISHES ON NEXT PAGE



Radial Reign
in Brushed Nickel

RADIAL REIGN AVAILABLE FINISHES, SIZES & PART NUMBERS

Handle Underside: Curved



MODERN BRUSHED GOLD

18in. CC	5139-4MDB-P
12in. CC	5053-4MDB-P
224mm CC	5052-4MDB-P
160mm CC	5051-4MDB-P
128mm CC	5050-4MDB-P
96mm CC	5049-4MDB-P
Knob	5048-4MDB-P



MODERN BRUSHED GOLD AND MATTE BLACK

18in. CC	<i>Not Available</i>
12in. CC	5146-4MDB55-P
224mm CC	5145-4MDB55-P
160mm CC	5144-4MDB55-P
128mm CC	5143-4MDB55-P
96mm CC	5142-4MDB55-P
Knob	5141-4MDB55-P



POLISHED CHROME

18in. CC	<i>Not Available</i>
12in. CC	5035-4026-P
224mm CC	5034-4026-P
160mm CC	5033-4026-P
128mm CC	5032-4026-P
96mm CC	5031-4026-P
Knob	5030-4026-P



SLATE

18in. CC	<i>Not Available</i>
12in. CC	5047-4SLT-P
224mm CC	5046-4SLT-P
160mm CC	5045-4SLT-P
128mm CC	5044-4SLT-P
96mm CC	5043-4SLT-P
Knob	5042-4SLT-P



Roque
in Matte Black



Swagger
in Black Nickel

Roque

FEATURED IN POLISHED CHROME

View display board on p. 137



ROQUE AVAILABLE FINISHES, SIZES & PART NUMBERS

Handle Underside: Curved



BLACK NICKEL

12in. CC	8125-1098-P
224mm CC	8124-1098-P
160mm CC	8123-1098-P
128mm CC	8122-1098-P
96mm CC	8121-1098-P
Knob	8120-1098-P



BRUSHED NICKEL

12in. CC	8101-1BPN-P
224mm CC	8100-1BPN-P
160mm CC	8099-1BPN-P
128mm CC	8098-1BPN-P
96mm CC	8097-1BPN-P
Knob	8096-1BPN-P



MATTE BLACK

12in. CC	8095-1055-P
224mm CC	8094-1055-P
160mm CC	8093-1055-P
128mm CC	8092-1055-P
96mm CC	8091-1055-P
Knob	8090-1055-P



MODERN BRUSHED GOLD

12in. CC	8107-1MDB-P
224mm CC	8106-1MDB-P
160mm CC	8105-1MDB-P
128mm CC	8104-1MDB-P
96mm CC	8103-1MDB-P
Knob	8102-1MDB-P



POLISHED CHROME

12in. CC	8119-1026-P
224mm CC	8118-1026-P
160mm CC	8117-1026-P
128mm CC	8116-1026-P
96mm CC	8115-1026-P
Knob	8114-1026-P



VINTAGE NICKEL

12in. CC	8113-1VTN-P
224mm CC	8112-1VTN-P
160mm CC	8111-1VTN-P
128mm CC	8110-1VTN-P
96mm CC	8109-1VTN-P
Knob	8108-1VTN-P

CC	PRODUCT TYPE	LENGTH	WIDTH	HEIGHT/ PROJECTION	HAND CLEARANCE	DIAMETER	BASE	TAP/SCREWS (QTY)
*12in.	Appliance Pull	12 1/2in.	2 5/32in.	1 1/2in.	2 9/32in.	-	1 9/32in.	10-24 x 1in. (2)
224mm	Pull	9 9/32in.	2 3/32in.	1 1/4in.	7/8in.	-	7/16in.	8-32 x 1in. (2)
160mm	Pull	6 2 5/32in.	2 1/32in.	1 7/32in.	2 7/32in.	-	1 3/32in.	8-32 x 1in. (2)
128mm	Pull	5 9/16in.	2 1/32in.	1 7/32in.	2 7/32in.	-	1 3/32in.	8-32 x 1in. (2)
96mm	Pull	4 9/32in.	2 1/32in.	1 7/32in.	2 9/32in.	-	1 3/32in.	8-32 x 1in. (2)
-	Knob	1 3/16in.	1 3/16in.	1 7/32in.	2 9/32in.	-	1 3/32in.	8-32 x 1in. (1)

*Product not shown, please visit BerensonHardware.com to view images and details.

Collection Material: Zinc



Skyline

FEATURED IN SLATE

View display board on p. 137



Knob
has pin at bottom to help secure in position

SKYLINE AVAILABLE FINISHES, SIZES & PART NUMBERS

Handle Underside: Flat



BRUSHED NICKEL

320mm CC	9974-1BPN-P
224mm CC	9206-1BPN-P
160mm CC	9203-1BPN-P
3in. & 96mm CC	9200-1BPN-P
Knob	9209-1BPN-P



MATTE BLACK

320mm CC	9975-1055-P
224mm CC	9208-1055-P
160mm CC	9205-1055-P
3in. & 96mm CC	9202-1055-P
Knob	9211-1055-P



MODERN BRUSHED GOLD

320mm CC	9993-1MDB-P
224mm CC	9978-1MDB-P
160mm CC	9977-1MDB-P
3in. & 96mm CC	9976-1MDB-P
Knob	9995-1MDB-P



POLISHED CHROME

320mm CC	1120-1026-P
224mm CC	9207-1026-P
160mm CC	9204-1026-P
3in. & 96mm CC	9201-1026-P
Knob	9210-1026-P



SLATE

320mm CC	1124-1SLT-P
224mm CC	1123-1SLT-P
160mm CC	1122-1SLT-P
3in. & 96mm CC	1121-1SLT-P
Knob	1125-1SLT-P

CC	PRODUCT TYPE	LENGTH	WIDTH	HEIGHT/ PROJECTION	HAND CLEARANCE	DIAMETER	BASE	TAP/SCREWS (QTY)
*320mm	Pull	13in.	5/8in.	1 1/16in.	7/8in.	-	1 3/8in.	8-32 x 1in. (2)
224mm	Pull	9 1/4in.	5/8in.	1 1/16in.	7/8in.	-	1 3/8in.	8-32 x 1in. (2)
160mm	Pull	6 1/16in.	5/8in.	1 1/16in.	7/8in.	-	1in.	8-32 x 1in. (2)
3in. & 96mm	Pull	4 3/4in.	5/8in.	1 1/16in.	7/8in.	-	1 3/8in.	8-32 x 1in. (2)
-	Knob	1 3/8in.	3/4in.	1 1/16in.	4 7/8in.	-	3/8in.	8-32 x 1in. (1)

*Product not shown, please visit BerensonHardware.com to view images and details.

Collection Material: Zinc

Stainless Steel

COLLECTION ONLY AVAILABLE IN STAINLESS STEEL FINISH

View display board on p. 137

Handle Underside: Curved



	PART NO.	CC	PRODUCT TYPE	LENGTH	WIDTH	HEIGHT/ PROJECTION	HAND CLEARANCE	DIAMETER	BASE	TAP/SCREWS (QTY)
	7067-9SS-C	*672mm	Pull	28 3/8in.	1/2in.	1 1/4in.	1 3/8in.	-	1/2in.	M4 x 45mm BO (3)
	7073-9SS-C	*448mm	Pull	19 9/16in.	1/2in.	1 1/4in.	1 3/8in.	-	1/2in.	M4 x 45mm BO (2)
	7072-9SS-C	*384mm	Pull	17 1/2in.	1/2in.	1 1/4in.	1 3/8in.	-	1/2in.	M4 x 45mm BO (2)
	7071-9SS-C	*288mm	Pull	13 3/8in.	1/2in.	1 1/4in.	1 3/8in.	-	1/2in.	M4 x 45mm BO (2)
	7077-9SS-C	*288mm	Pull	11 3/4in.	3/8in.	1 3/8in.	1 1/8in.	-	3/8in.	M4 x 45mm BO (2)
1	7076-9SS-C	128mm	Pull	5 1/8in.	3/8in.	1 3/8in.	1 1/8in.	-	3/8in.	M4 x 45mm BO (2)
2	7074-9SS-C	96mm	Pull	4 1/8in.	5/8in.	1 1/8in.	7/8in.	-	5/8in.	M4 x 45mm BO (2)
3	7075-9SS-C	96mm	Pull	4 3/8in.	3/8in.	1 3/8in.	1 1/8in.	-	3/8in.	M4 x 45mm BO (2)
4	7078-9SS-C	-	Knob	-	-	1 1/4in.	-	1 3/8in.	5/8in.	M4 x 45mm BO (1)
5	7079-9SS-C	-	Knob	-	-	1 1/8in.	-	1in.	7/8in.	M4 x 45mm BO (1)
6	7070-9SS-C	224mm	Pull	10 13/16in.	1/2in.	1 1/4in.	1 3/8in.	-	1/2in.	M4 x 45mm BO (2)
7	7069-9SS-C	160mm	Pull	8 1/4in.	1/2in.	1 1/4in.	1 3/8in.	-	1/2in.	M4 x 45mm BO (2)
8	7068-9SS-C	128mm	Pull	7in.	1/2in.	1 1/4in.	1 3/8in.	-	1/2in.	M4 x 45mm BO (2)

*Product not shown, please visit BerensonHardware.com to view images and details.

•Part is hollow

Collection Material: Stainless Steel
Grade 304

Studio

COLLECTION ONLY AVAILABLE IN STAINLESS STEEL FINISH

View display board on p. 137

Handle Underside: Curved

All parts are hollow



	PART NO.	CC	PRODUCT TYPE	LENGTH	WIDTH	HEIGHT/ PROJECTION	HAND CLEARANCE	DIAMETER	BASE	TAP/SCREWS (QTY)
	2027-90SS-P	*576mm	Pull	23 1/8in.	9/16in.	1 7/8in.	7/8in.	-	7/8in.	8-32 x 1in. (2)
	2011-90SS-P	*12in.	Appliance Pull	12 1/2in.	9/16in.	1 7/8in.	7/8in.	-	7/8in.	10-24 x 1in. (2)
	2026-90SS-P	*288mm	Pull	11 7/8in.	9/16in.	1 7/8in.	7/8in.	-	7/8in.	8-32 x 1in. (2)
	2025-90SS-P	256mm	Pull	10 5/8in.	9/16in.	1 7/8in.	7/8in.	-	7/8in.	8-32 x 1in. (2)
	2024-90SS-P	224mm	Pull	9 3/8in.	9/16in.	1 7/8in.	7/8in.	-	7/8in.	8-32 x 1in. (2)
	2023-90SS-P	192mm	Pull	8 1/8in.	9/16in.	1 7/8in.	7/8in.	-	7/8in.	8-32 x 1in. (2)
	2022-90SS-P	160mm	Pull	6 7/8in.	9/16in.	1 7/8in.	7/8in.	-	7/8in.	8-32 x 1in. (2)
	2021-90SS-P	128mm	Pull	5 5/8in.	9/16in.	1 7/8in.	7/8in.	-	7/8in.	8-32 x 1in. (2)
	2010-90SS-P	96mm	Pull	4 1/2in.	9/16in.	1 7/8in.	7/8in.	-	7/8in.	8-32 x 1in. (2)

*Product not shown, please visit BerensonHardware.com to view images and details.

Collection Material: Stainless Steel

NEW LENGTHS
NOW AVAILABLE



Studio Remix

NEW COLLECTION
SPRING 2026

FEATURED IN MODERN BRUSHED GOLD AND MATTE BLACK

View display board on p. 138

All parts are hollow



STUDIO REMIX AVAILABLE FINISHES, SIZES & PART NUMBERS

Handle Underside: Curved



BRUSHED NICKEL AND MATTE BLACK

12in. CC	2200-9BPN55-P
192mm CC	2195-9BPN55-P
160mm CC	2190-9BPN55-P
128mm CC	2185-9BPN55-P
96mm CC	2180-9BPN55-P



BRUSHED NICKEL AND POLISHED CHROME

12in. CC	2198-9BPN26-P
192mm CC	2193-9BPN26-P
160mm CC	2188-9BPN26-P
128mm CC	2183-9BPN26-P
96mm CC	2178-9BPN26-P



MATTE BLACK AND BRUSHED NICKEL

12in. CC	2199-955BPN-P
192mm CC	2194-955BPN-P
160mm CC	2189-955BPN-P
128mm CC	2184-955BPN-P
96mm CC	2179-955BPN-P



MATTE BLACK AND MODERN BRUSHED GOLD

12in. CC	2202-955MDB-P
192mm CC	2197-955MDB-P
160mm CC	2192-955MDB-P
128mm CC	2187-955MDB-P
96mm CC	2182-955MDB-P



MODERN BRUSHED GOLD AND MATTE BLACK

12in. CC	2201-9MDB55-P
192mm CC	2196-9MDB55-P
160mm CC	2191-9MDB55-P
128mm CC	2186-9MDB55-P
96mm CC	2181-9MDB55-P

CC	PRODUCT TYPE	LENGTH	WIDTH	HEIGHT/ PROJECTION	HAND CLEARANCE	DIAMETER	BASE	TAP/SCREWS (QTY)
*12in.	Appliance Pull	12 1/2in.	3/4in.	1 7/16in.	7/8in.	-	7/8in.	10-24 x 1in. (2)
192mm	Pull	8 1/8in.	3/4in.	1 7/16in.	7/8in.	-	7/8in.	8-32 x 1in. (2)
160mm	Pull	6 7/16in.	3/4in.	1 7/16in.	7/8in.	-	7/8in.	8-32 x 1in. (2)
128mm	Pull	5 5/16in.	3/4in.	1 7/16in.	7/8in.	-	7/8in.	8-32 x 1in. (2)
96mm	Pull	4 9/32in.	3/4in.	1 7/16in.	7/8in.	-	7/8in.	8-32 x 1in. (1)

*Product not shown, please visit BerensonHardware.com to view images and details.

Collection Material: Stainless Steel



FEATURED IN MODERN BRUSHED GOLD
View display board on p. 138



224mm CC

160mm CC

128mm CC

96mm CC



SWAGGER AVAILABLE FINISHES, SIZES & PART NUMBERS

Handle Underside: Flat



BLACK NICKEL

18in. CC	2416-1098-P
320mm CC	2323-1098-P
224mm CC	2320-1098-P
160mm CC	2317-1098-P
128mm CC	2314-1098-P
96mm CC	2385-1098-P
Knob	2326-1098-P



BRUSHED NICKEL

18in. CC	2413-1BPN-P
320mm CC	2321-1BPN-P
224mm CC	2318-1BPN-P
160mm CC	2315-1BPN-P
128mm CC	2312-1BPN-P
96mm CC	2386-1BPN-P
Knob	2324-1BPN-P



MATTE BLACK

18in. CC	2417-1055-P
320mm CC	2411-1055-P
224mm CC	2398-1055-P
160mm CC	2397-1055-P
128mm CC	2396-1055-P
96mm CC	2395-1055-P
Knob	2394-1055-P



MODERN BRUSHED GOLD

18in. CC	2415-1MDB-P
320mm CC	2367-1MDB-P
224mm CC	2366-1MDB-P
160mm CC	2365-1MDB-P
128mm CC	2364-1MDB-P
96mm CC	2387-1MDB-P
Knob	2368-1MDB-P



POLISHED CHROME

18in. CC	Not Available
320mm CC	2322-1026-P
224mm CC	2319-1026-P
160mm CC	2316-1026-P
128mm CC	2313-1026-P
96mm CC	2388-1026-P
Knob	2325-1026-P



SLATE

18in. CC	Not Available
320mm CC	2412-1SLT-P
224mm CC	2393-1SLT-P
160mm CC	2392-1SLT-P
128mm CC	2391-1SLT-P
96mm CC	2390-1SLT-P
Knob	2389-1SLT-P

CC	PRODUCT TYPE	LENGTH	WIDTH	HEIGHT/ PROJECTION	HAND CLEARANCE	DIAMETER	BASE	TAP/SCREWS (QTY)
*18in.	Appliance Pull	18 2 ³ / ₃₂ in.	2 ⁷ / ₃₂ in.	1 2 ⁵ / ₃₂ in.	1 1 ¹ / ₃₂ in.	-	2 ³ / ₃₂ in.	10-24 x 1in. (2)
*320mm	Pull	13 1 ¹ / ₁₆ in.	5 ¹ / ₁₆ in.	1 1 ¹ / ₁₆ in.	1 ¹ / ₁₆ in.	-	1 ¹ / ₁₆ in.	8-32 x 1in. (2)
224mm	Pull	9 5 ¹ / ₁₆ in.	5 ¹ / ₁₆ in.	1 1 ¹ / ₁₆ in.	1 ¹ / ₁₆ in.	-	1 ¹ / ₁₆ in.	8-32 x 1in. (2)
160mm	Pull	6 3 ¹ / ₁₆ in.	5 ¹ / ₁₆ in.	1 1 ¹ / ₁₆ in.	1 ¹ / ₁₆ in.	-	1 ¹ / ₁₆ in.	8-32 x 1in. (2)
128mm	Pull	5 1 ¹ / ₁₆ in.	5 ¹ / ₁₆ in.	1 1 ¹ / ₁₆ in.	1 ¹ / ₁₆ in.	-	1 ¹ / ₁₆ in.	8-32 x 1in. (2)
96mm	Pull	4 3 ¹ / ₁₆ in.	5 ¹ / ₁₆ in.	1 1 ¹ / ₁₆ in.	1 ¹ / ₁₆ in.	-	1 ¹ / ₁₆ in.	8-32 x 1in. (2)
-	Knob	1 3 ¹ / ₁₆ in.	1 3 ¹ / ₁₆ in.	1 1 ¹ / ₁₆ in.	7 ¹ / ₁₆ in.	-	7 ¹ / ₁₆ in.	8-32 x 1in. (1)

*Product not shown, please visit BerensonHardware.com to view images and details.

Collection Material: Zinc

Appliance Pulls

Shown to Scale

ELEVATE

320mm & 18in. Appliance Pull



AVAILABLE FINISHES *Featured in Graphite*

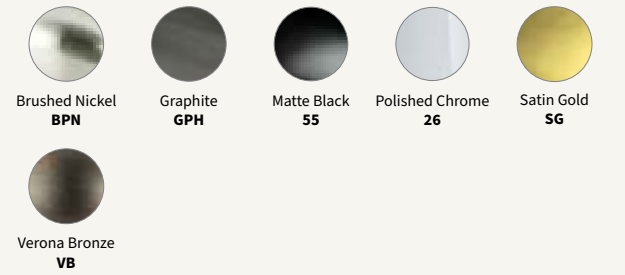

EPOCH EDGE

12in. Appliance Pull

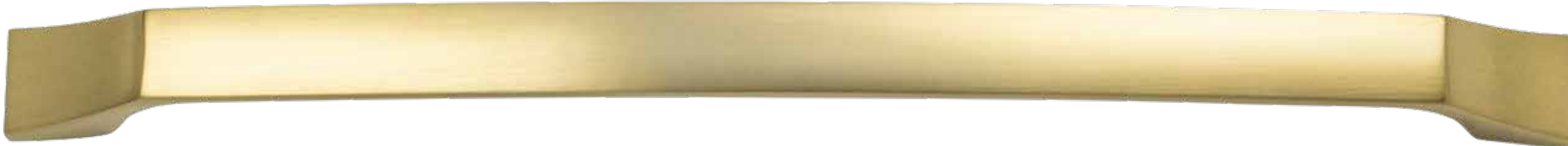

AVAILABLE FINISHES *Featured in Modern Brushed Gold*



LAURA

12in. Appliance Pull



AVAILABLE FINISHES *Featured in Modern Brushed Gold*





Appliance Pulls

Shown to Scale

METRO

18in. Appliance Pull



Appliance pulls add a cohesive look to your design with applications across your entire home. Designed for heavier use, they can be used on tall pantry doors, wide drawers and built-in appliances due to their secure 10-24 tap.

AVAILABLE FINISHES *Featured in Matte Black*



RADIAL REIGN

12in. & 18in. Appliance Pull



AVAILABLE FINISHES *Featured in Slate*

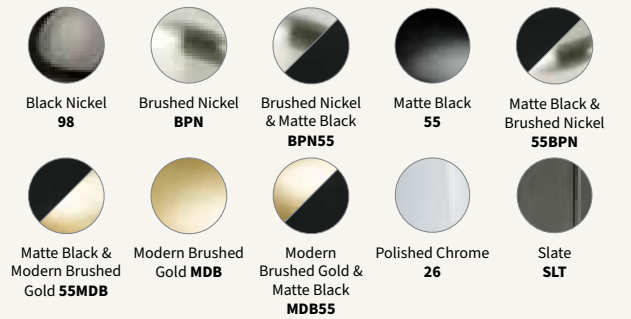

Not all finishes available in both lengths.

ROQUE

12in. Appliance Pull



AVAILABLE FINISHES *Featured in Polished Chrome*

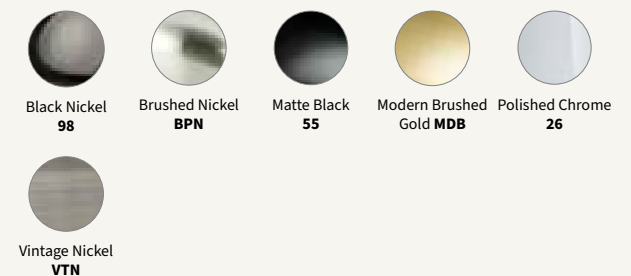

Appliance Pulls

Shown to Scale

STUDIO

12in. Appliance Pull



AVAILABLE FINISHES *Featured in Stainless Steel*



Stainless Steel
SS

STUDIO REMIX

12in. Appliance Pull



AVAILABLE FINISHES *Featured in Modern Brushed Gold & Matte Black*



Brushed Nickel & Matte Black
BPN55



Brushed Nickel & Polished Chrome
BPN26



Matte Black & Brushed Nickel
55BPN



Matte Black & Modern Brushed Gold
55MDB



Modern Brushed Gold & Matte Black
MDB55

SWAGGER

18in. Appliance Pull



AVAILABLE FINISHES *Featured in Modern Brushed Gold*



Black Nickel
98



Brushed Nickel
BPN



Matte Black
55



Modern Brushed Gold
MDB

Appliance pulls add a cohesive look to your design with applications across your entire home. Designed for heavier use, they can be used on tall pantry doors, wide drawers and built-in appliances due to their secure 10-24 tap.



Radial Reign
*in Matte Black and
Modern Brushed Gold*

Emerling
in Modern Brushed Gold

TRADITIONAL STYLE

Timeless Charm

Bring strength and grace through classic hardware designs to reach an inviting, timeless impact.





Echo

FEATURED IN MODERN BRUSHED GOLD

View display board on p. 138

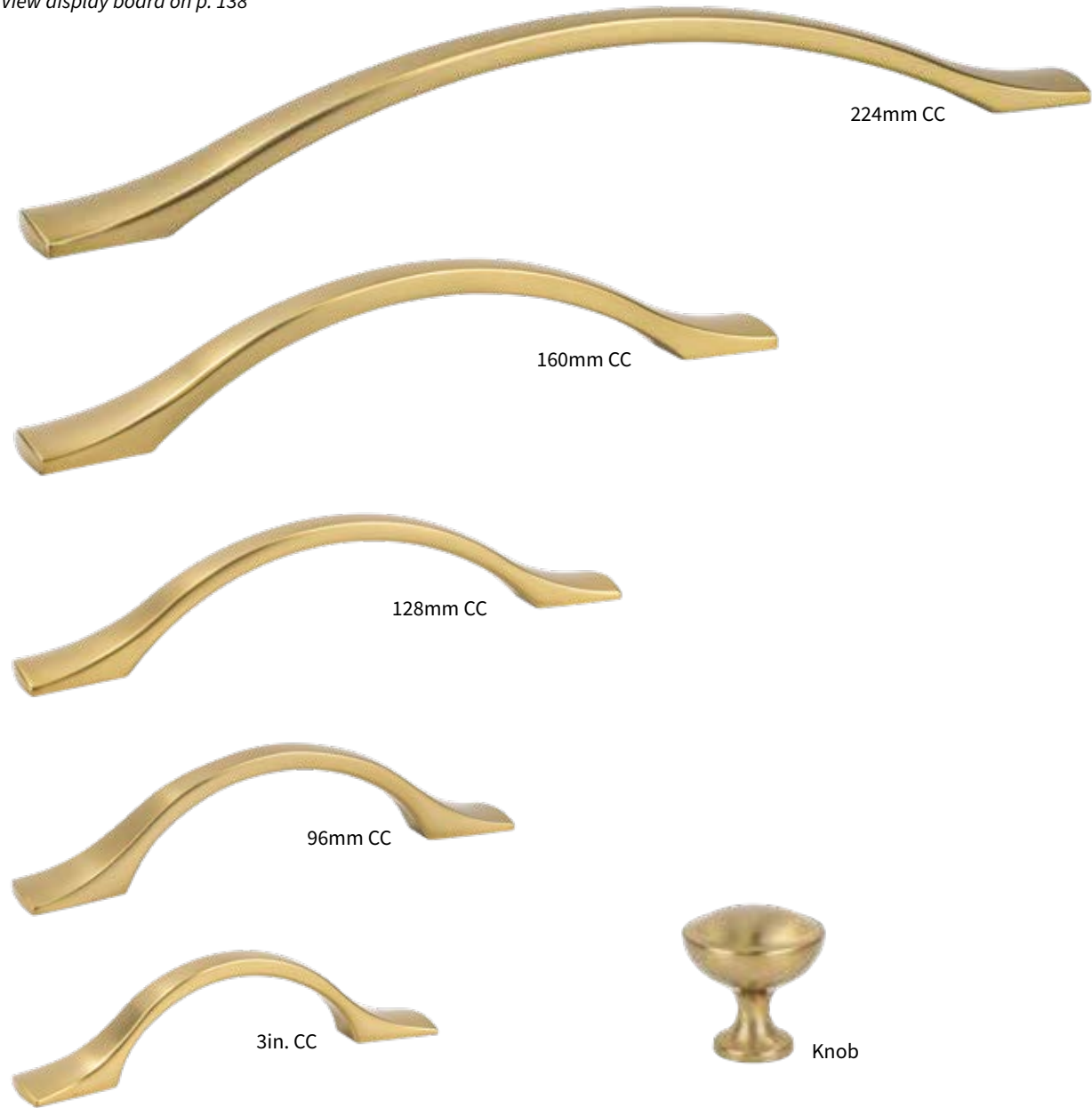

CC	PRODUCT TYPE	LENGTH	WIDTH	HEIGHT/ PROJECTION	HAND CLEARANCE	DIAMETER	BASE	TAP/SCREWS (QTY)
*18in.	Appliance Pull	19 3/4in.	1 13/32in.	2 1/16in.	1 1/2in.	-	1 1/2in.	10-24 x 1in. (2)
*12in.	Appliance Pull	13 23/32in.	1 1/16in.	1 21/32in.	1 3/16in.	-	1 11/32in.	10-24 x 1in. (2)
224mm	Pull	10 9/16in.	1 5/16in.	1 3/16in.	1 3/32in.	-	1 3/16in.	8-32 x 1in. (2)
160mm	Pull	8 1/2in.	27/32in.	1 5/16in.	1 1/32in.	-	1 3/16in.	8-32 x 1in. (2)
128mm	Pull	6 23/32in.	1 3/16in.	1 1/4in.	1 1/32in.	-	1 1/16in.	8-32 x 1in. (2)
96mm	Pull	5 9/16in.	3/4in.	1 1/4in.	61/64in.	-	1 1/16in.	8-32 x 1in. (2)
3in.	Pull	4 3/4in.	3/4in.	1 1/16in.	63/64in.	-	1in.	8-32 x 1in. (2)
-	Knob	-	-	1 3/16in.	-	1 3/16in.	5/8in.	8-32 x 1in. (1)

*Product not shown, please visit BerensonHardware.com to view images and details.

Collection Material: Zinc

ECHO AVAILABLE FINISHES, SIZES & PART NUMBERS

Handle Underside: Flat



BRUSHED NICKEL

18in. CC	9109-1BPN-P
12in. CC	9142-1BPN-P
224mm CC	9141-1BPN-P
160mm CC	9140-1BPN-P
128mm CC	9139-1BPN-P
96mm CC	9225-1BPN-P
3in. CC	9222-1BPN-P
Knob	9228-1BPN-P



MATTE BLACK

18in. CC	9147-1055-P
12in. CC	9146-1055-P
224mm CC	9145-1055-P
160mm CC	9144-1055-P
128mm CC	9143-1055-P
96mm CC	9261-1055-P
3in. CC	9260-1055-P
Knob	9262-1055-P



MODERN BRUSHED GOLD

18in. CC	9168-1MDB-P
12in. CC	9167-1MDB-P
224mm CC	9166-1MDB-P
160mm CC	9165-1MDB-P
128mm CC	9164-1MDB-P
96mm CC	9163-1MDB-P
3in. CC	9162-1MDB-P
Knob	9161-1MDB-P



OIL RUBBED BRONZE

18in. CC	Not Available
12in. CC	9151-1ORB-P
224mm CC	9150-1ORB-P
160mm CC	9149-1ORB-P
128mm CC	9148-1ORB-P
96mm CC	9224-1ORB-P
3in. CC	9221-1ORB-P
Knob	9227-1ORB-P



POLISHED NICKEL

18in. CC	Not Available
12in. CC	9155-1014-P
224mm CC	9154-1014-P
160mm CC	9153-1014-P
128mm CC	9152-1014-P
96mm CC	9258-1014-P
3in. CC	9257-1014-P
Knob	9259-1014-P



VERONA BRONZE

18in. CC	Not Available
12in. CC	9159-10VB-P
224mm CC	9158-10VB-P
160mm CC	9157-10VB-P
128mm CC	9156-10VB-P
96mm CC	9226-10VB-P
3in. CC	9223-10VB-P
Knob	9229-10VB-P

Emerling

NEW COLLECTION
SPRING 2026

FEATURED IN MATTE BLACK

View display board on p. 138



EMERLING AVAILABLE FINISHES, SIZES & PART NUMBERS

Handle Underside: Semi-Curved



BRUSHED NICKEL

12in. CC	2461-1BPN-P
224mm CC	2458-1BPN-P
160mm CC	2455-1BPN-P
128mm CC	2452-1BPN-P
96mm CC	2449-1BPN-P
96mm CC Cup Pull	2464-1BPN-P
Knob	2446-1BPN-P



MATTE BLACK

12in. CC	2462-1055-P
224mm CC	2459-1055-P
160mm CC	2456-1055-P
128mm CC	2453-1055-P
96mm CC	2450-1055-P
96mm CC Cup Pull	2465-1055-P
Knob	2447-1055-P



MODERN BRUSHED GOLD

12in. CC	2463-1MDB-P
224mm CC	2460-1MDB-P
160mm CC	2457-1MDB-P
128mm CC	2454-1MDB-P
96mm CC	2451-1MDB-P
96mm CC Cup Pull	2466-1MDB-P
Knob	2448-1MDB-P



CC	PRODUCT TYPE	LENGTH	WIDTH	HEIGHT/ PROJECTION	HAND CLEARANCE	DIAMETER	BASE	TAP/SCREWS (QTY)
*12in.	Appliance Pull	13 1/4in.	1 3/16in.	1 3/16in.	3 1/2in.	-	1 3/16in.	10-24 x 1in. (2)
224mm	Pull	9 29/32in.	2 1/32in.	1 9/32in.	2 9/32in.	-	2 1/32in.	8-32 x 1in. (2)
160mm	Pull	7 3/8in.	2 1/32in.	1 9/32in.	2 9/32in.	-	2 1/32in.	8-32 x 1in. (2)
128mm	Pull	6 1/8in.	2 1/32in.	1 9/32in.	2 9/32in.	-	2 1/32in.	8-32 x 1in. (2)
96mm	Pull	4 7/8in.	2 1/32in.	1 9/32in.	2 9/32in.	-	2 1/32in.	8-32 x 1in. (2)
96mm	Cup Pull	4 3/8in.	1 9/16in.	1 3/8in.	-	-	-	8-32 x 1in. (2)
-	Knob	1 3/8in.	3 1/32in.	1 3/8in.	-	-	1 3/16in.	8-32 x 1in. (1)

*Product not shown, please visit BerensonHardware.com to view images and details.

Collection Material: Zinc



Folklore
in Modern Brushed Gold



Hearthstone
in Matte Black

Folklore

FEATURED IN MODERN BRUSHED GOLD

View display board on p. 139



FOLKLORE AVAILABLE FINISHES, SIZES & PART NUMBERS

Handle Underside: Curved



BRUSHED NICKEL

18in. CC	8341-1BPN-P
12in. CC	8319-1BPN-P
224mm CC	8318-1BPN-P
160mm CC	8317-1BPN-P
128mm CC	8316-1BPN-P
96mm CC	8315-1BPN-P
3in. CC	8340-1BPN-P
Knob	8314-1BPN-P



MATTE BLACK

18in. CC	8342-1055-P
12in. CC	8313-1055-P
224mm CC	8312-1055-P
160mm CC	8311-1055-P
128mm CC	8310-1055-P
96mm CC	8309-1055-P
3in. CC	9947-1055-P
Knob	8308-1055-P



MODERN BRUSHED GOLD

18in. CC	8343-1MDB-P
12in. CC	8307-1MDB-P
224mm CC	8306-1MDB-P
160mm CC	8305-1MDB-P
128mm CC	8304-1MDB-P
96mm CC	8303-1MDB-P
3in. CC	9946-1MDB-P
Knob	8302-1MDB-P



TOASTED BRONZE

18in. CC	Not Available
12in. CC	8337-10TB-P
224mm CC	8336-10TB-P
160mm CC	8335-10TB-P
128mm CC	8334-10TB-P
96mm CC	8333-10TB-P
3in. CC	8338-10TB-P
Knob	8332-10TB-P



WEATHERED COPPER

18in. CC	Not Available
12in. CC	8331-10WC-P
224mm CC	8330-10WC-P
160mm CC	8329-10WC-P
128mm CC	8328-10WC-P
96mm CC	8327-10WC-P
3in. CC	8339-10WC-P
Knob	8326-10WC-P

CC	PRODUCT TYPE	LENGTH	WIDTH	HEIGHT/ PROJECTION	HAND CLEARANCE	DIAMETER	BASE	TAP/SCREWS (QTY)
*18in.	Appliance Pull	19 1/32in.	1 1/32in.	1 25/32in.	1 3/32in.	-	1 1/32in.	10-24 x 1in. (2)
*12in.	Appliance Pull	13 3/16in.	1 5/32in.	1 1/32in.	7/16in.	-	1 3/16in.	10-24 x 1in. (2)
224mm	Pull	9 29/32in.	7/16in.	1 9/32in.	27/32in.	-	1 3/32in.	8-32 x 1in. (2)
160mm	Pull	7 3/8in.	13/32in.	1 7/32in.	13/16in.	-	1 1/16in.	8-32 x 1in. (2)
128mm	Pull	6 1/16in.	3/8in.	1 1/16in.	13/16in.	-	1 1/32in.	8-32 x 1in. (2)
96mm	Pull	4 13/16in.	1 1/32in.	1 3/16in.	13/16in.	-	1 1/32in.	8-32 x 1in. (2)
3in.	Cup Pull	4 1 1/16in.	1 7/16in.	1 5/16in.	-	-	-	8-32 x 1in. (2)
-	Knob	-	-	1 1/16in.	-	1 3/16in.	1 1/32in.	8-32 x 1in. (1)

*Product not shown, please visit BerensonHardware.com to view images and details.

Collection Material: Zinc

Harmony

FEATURED IN VINTAGE NICKEL

View display board on p. 139



HARMONY AVAILABLE FINISHES, SIZES & PART NUMBERS

Handle Underside: Flat

Parts in the Harmony Collection feature removable inserts that can be interchanged with other parts of the same length to create a unique mixed metal piece. Please note that pieces do not come as mixed metal. Hardware must be purchased separately and mixed as needed for design.



BRUSHED NICKEL

160mm CC	9456-1BPN-P
128mm CC	9450-1BPN-P
96mm CC	9444-1BPN-P
3in. CC	9438-1BPN-P
Knob	9462-1BPN-P



VERONA BRONZE

160mm CC	9455-10VB-P
128mm CC	9449-10VB-P
96mm CC	9443-10VB-P
3in. CC	9437-10VB-P
Knob	9461-10VB-P



VINTAGE NICKEL

160mm CC	9579-1VTN-P
128mm CC	9578-1VTN-P
96mm CC	9577-1VTN-P
3in. CC	9576-1VTN-P
Knob	9580-1VTN-P

CC	PRODUCT TYPE	LENGTH	WIDTH	HEIGHT/ PROJECTION	HAND CLEARANCE	DIAMETER	BASE	TAP/SCREWS (QTY)
160mm	Pull	6 7/8in.	1 1/4in.	1 1/8in.	5 1/4in.	-	9/16in.	8-32 x 1 1/8in. (2)
128mm	Pull	5 1 1/8in.	1 1/4in.	1 1/8in.	5 1/4in.	-	9/16in.	8-32 x 1 1/8in. (2)
96mm	Pull	4 7/8in.	1 1/4in.	1 1/8in.	5 1/4in.	-	9/16in.	8-32 x 1 1/8in. (2)
3in.	Pull	3 1 1/8in.	1 1/4in.	1 1/8in.	5 1/4in.	-	9/16in.	8-32 x 1 1/8in. (2)
-	Knob	1 3/4in.	1 3/4in.	1 1/8in.	1 3/4in.	-	9/16in.	8-32 x 1 1/8in. (1)

Collection Material: Zinc



Hearthstone

FEATURED IN MATTE BLACK

View display board on p. 139



CC	PRODUCT TYPE	LENGTH	WIDTH	HEIGHT/ PROJECTION	HAND CLEARANCE	DIAMETER	BASE	TAP/SCREWS (QTY)
*18in.	Appliance Pull	19 1/4in.	1 1/2in.	1 3/8in.	1 3/8in.	-	1 3/8in.	10-24 x 1in. (2)
*12in.	Appliance Pull	13 3/8in.	3/4in.	1 1/4in.	1 23/64in.	-	1 1/4in.	10-24 x 1in. (2)
**6in.	Pull	7 3/8in.	1 1/8in.	1 1/8in.	1 5/32in.	-	1 1/8in.	8-32 x 1in. (2)
160mm	Pull	7 5/8in.	3/4in.	1 1/2in.	1 23/64in.	-	7/8in.	8-32 x 1in. (2)
128mm	Pull	6 1/8in.	1/2in.	1 7/8in.	1 1/4in.	-	7/8in.	8-32 x 1in. (2)
96mm	Pull	4 1 3/8in.	3/8in.	1 3/8in.	6 1/64in.	-	7/8in.	8-32 x 1in. (2)
3in.	Pull	3 1 5/8in.	3/8in.	1 3/8in.	6 1/64in.	-	1 3/8in.	8-32 x 1in. (2)
-	Knob	1 3/8in.	1 1/8in.	1 1/8in.	3/4in.	-	1 3/8in.	8-32 x 1in. (1)

*Product not shown, please visit BerensonHardware.com to view images and details.

**The 6in. CC pull features a wider width that adds dimension to kitchen and bath designs.

Collection Material: Zinc

HEARTHSTONE AVAILABLE FINISHES, SIZES & PART NUMBERS

Handle Underside: Semi-Curved

See Designers' Group Ten collection on pages 25-26 to view the Polished Nickel finish.

BRUSHED NICKEL		MATTE BLACK		MODERN BRUSHED GOLD	
18in. CC	2168-1BPN-P	18in. CC	2169-1055-P	18in. CC	2157-1MDB-P
12in. CC	2035-1BPN-P	12in. CC	2038-1055-P	12in. CC	2156-1MDB-P
6in. CC	4076-1BPN-P	6in. CC	4080-1055-P	6in. CC	2155-1MDB-P
160mm CC	2045-1BPN-P	160mm CC	2048-1055-P	160mm CC	2154-1MDB-P
128mm CC	2040-1BPN-P	128mm CC	2043-1055-P	128mm CC	2153-1MDB-P
96mm CC	4070-1BPN-P	96mm CC	4074-1055-P	96mm CC	2152-1MDB-P
3in. CC	4064-1BPN-P	3in. CC	4068-1055-P	3in. CC	2151-1MDB-P
Knob	4083-1BPN-P	Knob	4086-1055-P	Knob	2158-1MDB-P

VERONA BRONZE		VINTAGE NICKEL		WEATHERED VERONA BRONZE	
18in. CC	2167-10VB-P	18in. CC	2165-1VTN-P	18in. CC	Not Available
12in. CC	2034-10VB-P	12in. CC	2164-1VTN-P	12in. CC	2037-1WVB-P
6in. CC	4075-10VB-P	6in. CC	2163-1VTN-P	6in. CC	4079-1WVB-P
160mm CC	2044-10VB-P	160mm CC	2162-1VTN-P	160mm CC	2047-1WVB-P
128mm CC	2039-10VB-P	128mm CC	2161-1VTN-P	128mm CC	2042-1WVB-P
96mm CC	4069-10VB-P	96mm CC	2160-1VTN-P	96mm CC	4073-1WVB-P
3in. CC	4063-10VB-P	3in. CC	2159-1VTN-P	3in. CC	4067-1WVB-P
Knob	4081-10VB-P	Knob	2166-1VTN-P	Knob	4085-1WVB-P

Tailored Traditional

FEATURED IN MATTE BLACK

View display board on p. 139



Knob
has pin at bottom to help secure in position

TAILORED TRADITIONAL AVAILABLE FINISHES, SIZES & PART NUMBERS

Handle Underside: Curved



BRUSHED NICKEL

12in. CC	1302-1BPN-P
224mm CC	1296-1BPN-P
160mm CC	1290-1BPN-P
128mm CC	1284-1BPN-P
96mm CC	1278-1BPN-P
Knob	1272-1BPN-P



MATTE BLACK

12in. CC	1305-1055-P
224mm CC	1299-1055-P
160mm CC	1293-1055-P
128mm CC	1287-1055-P
96mm CC	1281-1055-P
Knob	1275-1055-P



MODERN BRUSHED GOLD

12in. CC	1306-1MDB-P
224mm CC	1300-1MDB-P
160mm CC	1294-1MDB-P
128mm CC	1288-1MDB-P
96mm CC	1282-1MDB-P
Knob	1276-1MDB-P



POLISHED NICKEL

12in. CC	1304-1014-P
224mm CC	1298-1014-P
160mm CC	1292-1014-P
128mm CC	1286-1014-P
96mm CC	1280-1014-P
Knob	1274-1014-P



VERONA BRONZE

12in. CC	1303-10VB-P
224mm CC	1297-10VB-P
160mm CC	1291-10VB-P
128mm CC	1285-10VB-P
96mm CC	1279-10VB-P
Knob	1273-10VB-P



VINTAGE NICKEL

12in. CC	1307-1VTN-P
224mm CC	1301-1VTN-P
160mm CC	1295-1VTN-P
128mm CC	1289-1VTN-P
96mm CC	1283-1VTN-P
Knob	1277-1VTN-P

CC	PRODUCT TYPE	LENGTH	WIDTH	HEIGHT/ PROJECTION	HAND CLEARANCE	DIAMETER	BASE	TAP/SCREWS (QTY)
*12in.	Appliance Pull	13in.	1in.	1 1/16in.	1 1/8in.	-	1in.	10-24 x 1in. (2)
224mm	Pull	9 5/8in.	1 3/16in.	1 3/8in.	1in.	-	1 3/16in.	8-32 x 1in. (2)
160mm	Pull	7in.	1 1/16in.	1 3/8in.	1 1/4in.	-	1 1/16in.	8-32 x 1in. (2)
128mm	Pull	5 3/4in.	2 3/32in.	1 1/8in.	1 1/4in.	-	2 3/32in.	8-32 x 1in. (2)
96mm	Pull	4 1/2in.	2 3/32in.	1 1/8in.	1in.	-	2 3/32in.	8-32 x 1in. (2)
-	Knob	1 1/4in.	1 1/4in.	1 1/4in.	2 1/32in.	-	1 1/16in.	8-32 x 1in. (1)

*Product not shown, please visit BerensonHardware.com to view images and details.

Collection Material: Zinc

Vested Interest

FEATURED IN VINTAGE NICKEL

View display board on p. 139



224mm CC

160mm CC

128mm CC

96mm CC



Knob
has pin at bottom to help secure in position

CC	PRODUCT TYPE	LENGTH	WIDTH	HEIGHT/ PROJECTION	HAND CLEARANCE	DIAMETER	BASE	TAP/SCREWS (QTY)
*12in.	Appliance Pull	13 13/16in.	15/16in.	1 3/4in.	1 1/4in.	-	3/8in.	10-24 x 1in. (2)
224mm	Pull	9 3/4in.	3/4in.	1 3/8in.	1 1/8in.	-	9/16in.	8-32 x 1in. (2)
160mm	Pull	7 1/4in.	1 1/16in.	1 1/2in.	29/32in.	-	1/2in.	8-32 x 1in. (2)
128mm	Pull	6in.	5/8in.	1 3/4in.	53/64in.	-	1/2in.	8-32 x 1in. (2)
96mm	Pull	4 3/4in.	5/8in.	1 3/4in.	53/64in.	-	1/2in.	8-32 x 1in. (2)
-	Knob	-	-	1 5/16in.	41/64in.	1 1/4in.	1 1/16in.	8-32 x 1in. (1)

*Product not shown, please visit BerensonHardware.com to view images and details.

Collection Material: Zinc

VESTED INTEREST AVAILABLE FINISHES, SIZES & PART NUMBERS

Handle Underside: Flat



BRUSHED NICKEL

12in. CC	2335-1BPN-P
224mm CC	2333-1BPN-P
160mm CC	2331-1BPN-P
128mm CC	2329-1BPN-P
96mm CC	2327-1BPN-P
Knob	2337-1BPN-P



VERONA BRONZE

12in. CC	2336-10VB-P
224mm CC	2334-10VB-P
160mm CC	2332-10VB-P
128mm CC	2330-10VB-P
96mm CC	2328-10VB-P
Knob	2338-10VB-P



VINTAGE NICKEL

12in. CC	2373-1VTN-P
224mm CC	2372-1VTN-P
160mm CC	2371-1VTN-P
128mm CC	2370-1VTN-P
96mm CC	2369-1VTN-P
Knob	2374-1VTN-P



Vibrato

ONLY AVAILABLE IN VERONA BRONZE

View display board on p. 140



① 128mm CC
curved underside



④ Knob



② 96mm CC
curved underside



⑤ 3in. CC
flat underside



③ Knob
has pin at bottom to help secure in position



⑥ 96mm CC
flat underside



⑦ Hook



⑧ Knob



⑨ Knob



⑩ 128mm CC
flat underside



⑪ Knob
has pin at bottom to help secure in position



⑫ 3in. CC
curved underside



⑬ 3in. CC
flat underside



⑭ 3in. CC
curved underside



⑮ 64mm CC
curved underside

	PART NO.	CC	PRODUCT TYPE	LENGTH	WIDTH	HEIGHT/ PROJECTION	HAND CLEARANCE	DIAMETER	BASE	TAP/SCREWS (QTY)
1	7904-1VB-P	128mm	Pull	6 7/8in.	5/8in.	1 5/8in.	-	-	1/2in.	8-32 x 1in. (2)
2	7905-1VB-P	96mm	Pull	5 3/8in.	5/8in.	1 1/8in.	-	-	1/2in.	8-32 x 1in. (2)
3	7906-1VB-P	-	Knob	1 1/8in.	1/2in.	1 3/8in.	-	-	1/2in.	8-32 x 1in. (1)
4	7895-1VB-P	-	Knob	-	-	1in.	-	1 3/8in.	1in.	8-32 x 1in. (1)
5	7898-1VB-P	3in.	Pull	4 3/8in.	7/8in.	1 3/8in.	-	-	1/2in.	8-32 x 1in. (2)
6	7890-1VB-P	96mm	Pull	4 1/8in.	1 1/8in.	1 1/8in.	5/8in.	-	1 1/8in.	8-32 x 1in. (2)
7	8016-VB-P	-	Hook	4in.	3/8in.	3 1/8in.	-	-	1 1/8in.	5/8in. Wood (4)
8	7878-1VB-P	-	Knob	1 5/8in.	7/8in.	1 1/4in.	-	-	5/8in.	8-32 x 1in. (1)
9	7899-1VB-P	-	Knob	-	-	1 1/8in.	-	1 1/4in.	3/4in.	8-32 x 1in. (1)
10	+7883-1VB-P	128mm	Pull	5 1/8in.	5/8in.	1 1/4in.	5/8in.	-	5/8in.	8-32 x 1in. (2)
11	7897-1VB-P	-	Knob	1 7/8in.	1 1/8in.	1in.	-	-	7/8in.	8-32 x 1in. (1)
12	7901-1VB-P	3in.	Pull	3 3/8in.	3/8in.	1 1/4in.	-	-	3/8in.	8-32 x 1in. (2)
13	7900-1VB-P	3in.	Pull	4 1/8in.	3/8in.	1 3/8in.	4/8in.	-	3/4in.	8-32 x 1in. (2)
14	7876-1VB-P	3in.	Cup Pull	4 5/8in.	1 3/8in.	1in.	5/8in.	-	-	8-32 x 1in. (2)
15	7886-1VB-P	64mm	Cup Pull	4 1/8in.	1 1/4in.	1in.	7/8in.	-	-	8-32 x 1in. (2)

+2 Additional 8-32 x 1 3/4in. break-off screws provided.

Collection Material: Zinc



Village

FEATURED IN BRUSHED NICKEL

View display board on p. 140



CC	PRODUCT TYPE	LENGTH	WIDTH	HEIGHT/ PROJECTION	HAND CLEARANCE	DIAMETER	BASE	TAP/SCREWS (QTY)
*256mm	Appliance Pull	12 3/16in.	1 5/16in.	1 5/16in.	1 1/2in.	-	1 5/16in.	10-24 x 1in. (2)
160mm	Pull	8 1/8in.	5/8in.	1 1/8in.	2 5/32in.	-	1 3/16in.	8-32 x 1in. (2)
128mm	Pull	6 7/8in.	5/8in.	1 1/8in.	3/4in.	-	1 3/16in.	8-32 x 1in. (2)
96mm	Pull	5 3/8in.	5/8in.	1 5/16in.	1 1/4in.	-	1 3/16in.	8-32 x 1in. (2)
3in.	Pull	4 5/8in.	5/8in.	1 5/16in.	4 1/64in.	-	1 1/16in.	8-32 x 1in. (2)

*Product not shown, please visit BerensonHardware.com to view images and details.

Collection Material: Zinc

VILLAGE AVAILABLE FINISHES, SIZES & PART NUMBERS

Handle Underside: Flat



BRUSHED NICKEL

256mm CC	2083-1BPN-P
160mm CC	2081-1BPN-P
128mm CC	2079-1BPN-P
96mm CC	2077-1BPN-P
3in. CC	2075-1BPN-P



VERONA BRONZE

256mm CC	2084-10VB-P
160mm CC	2082-10VB-P
128mm CC	2080-10VB-P
96mm CC	2078-10VB-P
3in. CC	2076-10VB-P





Appliance Pulls

Shown to Scale

ECHO

12in. & 18in. Appliance Pull



AVAILABLE FINISHES *Featured in Modern Brushed Gold*

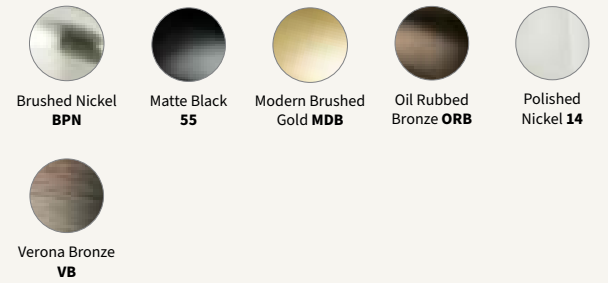

Not all finishes available in both lengths.

EMERLING

12in. Appliance Pull



AVAILABLE FINISHES *Featured in Matte Black*

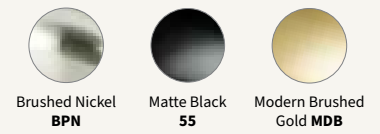

FOLKLORE

12in. & 18in. Appliance Pull



AVAILABLE FINISHES *Featured in Toasted Bronze*



Not all finishes available in both lengths.



Appliance Pulls

Shown to Scale

HEARTHSTONE

12in. & 18in. Appliance Pull



TAILORED TRADITIONAL

12in. Appliance Pull



VESTED INTEREST

12in. Appliance Pull



Appliance pulls add a cohesive look to your design with applications across your entire home. Designed for heavier use, they can be used on tall pantry doors, wide drawers and built-in appliances due to their secure 10-24 tap.

AVAILABLE FINISHES *Featured in Brushed Nickel*



Not all finishes available in both lengths.

AVAILABLE FINISHES *Featured in Matte Black*



AVAILABLE FINISHES *Featured in Verona Bronze*

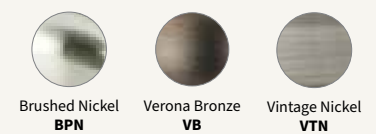



Appliance Pulls

Shown to Scale

VILLAGE

256mm Appliance Pull



AVAILABLE FINISHES *Featured in Verona Bronze*



Brushed Nickel
BPN

Verona Bronze
VB

Appliance pulls add a cohesive look to your design with applications across your entire home. Designed for heavier use, they can be used on tall pantry doors, wide drawers and built-in appliances due to their secure 10-24 tap.



Tailored Traditional
in Matte Black

CRAFTSMAN STYLE

Artisan Inspired

Craft an artistic and unique look by using distinct hardware designs that excite the eye.



Rhapsody
in Black

Art Nouveau

FEATURED IN VINTAGE NICKEL

View display board on p. 140

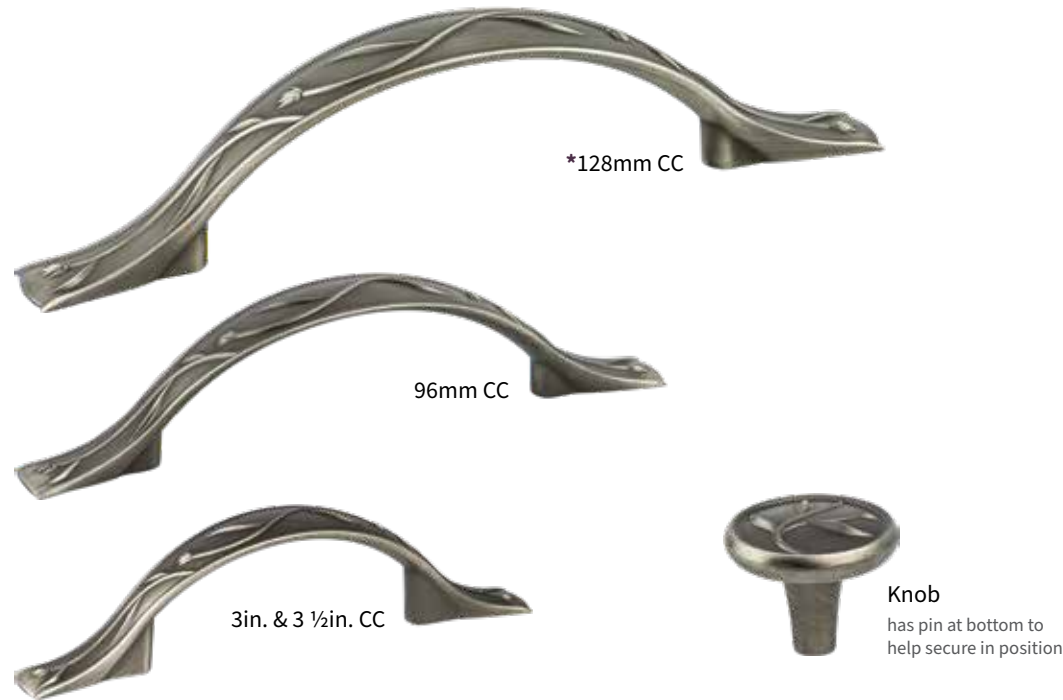

ART NOUVEAU AVAILABLE FINISHES, SIZES & PART NUMBERS

Handle Underside: Semi-Curved



VERONA BRONZE



VINTAGE NICKEL

128mm CC	4014-10VB-P
96mm CC	4011-10VB-P
3in. & 3 1/2in. CC	4134-10VB-P
Knob	4017-10VB-P

128mm CC	4015-1VTN-P
96mm CC	4012-1VTN-P
3in. & 3 1/2in. CC	4135-1VTN-P
Knob	4018-1VTN-P

CC	PRODUCT TYPE	LENGTH	WIDTH	HEIGHT/ PROJECTION	HAND CLEARANCE	DIAMETER	BASE	TAP/SCREWS (QTY)
*128mm	Pull	7 1/16in.	1in.	1 3/4in.	1 7/16in.	-	1 1/16in.	8-32 x 1in. (2)
96mm	Pull	5 1/16in.	1 1/16in.	1 5/16in.	1 5/16in.	-	5/16in.	8-32 x 1in. (2)
3in. & 3 1/2in.	Pull	5 1/4in.	1 1/16in.	1 1/4in.	1 7/16in.	-	5/16in.	8-32 x 1in. (2)
-	Knob	-	-	1 1/8in.	5/16in.	1 3/8in.	5/16in.	8-32 x 1in. (1)

*The 128mm CC pull features a wider width that adds dimension to kitchen and bath designs.

Collection Material: Zinc

Rhapsody

FEATURED IN BLACK

View display board on p. 140



RHAPSODY AVAILABLE FINISHES, SIZES & PART NUMBERS

Handle Underside: Semi-Curved



BLACK



WEATHERED IRON

128mm CC	3040-155-P
96mm CC	3043-155-P
1 Knob	3046-155-P
2 Knob	3049-155-P
3 Knob	3052-155-P
4 Knob	3055-155-P

128mm CC	3041-1LWI-P
96mm CC	3044-1LWI-P
1 Knob	3047-1LWI-P
2 Knob	3050-1LWI-P
3 Knob	3053-1LWI-P
4 Knob	Not Available

	CC	PRODUCT TYPE	LENGTH	WIDTH	HEIGHT/ PROJECTION	HAND CLEARANCE	DIAMETER	BASE	TAP/SCREWS (QTY)
1	-	Knob	2 1/2in.	1/2in.	1 1/8in.	2 1/32in.	-	3/8in.	8-32 x 1in. (1)
2	-	Knob	1 3/4in.	1 3/16in.	1 1/8in.	1 7/32in.	-	3/8in.	8-32 x 1in. (1)
3	-	Knob	-	-	1in.	2 3/16in.	1 1/16in.	3/8in.	8-32 x 1in. (1)
4	-	Knob	-	-	1 1/8in.	1/2in.	1 1/8in.	3/8in.	8-32 x 1in. (1)
5	128mm	Pull	5 7/16in.	3/8in.	1 1/8in.	5 3/16in.	-	3/8in.	8-32 x 1in. (2)
6	96mm	Pull	4 3/16in.	3/8in.	1 1/8in.	5 3/16in.	-	3/8in.	8-32 x 1in. (2)

Collection Material: Zinc

Complete The Look

Accessories designed to complete the
look with style.



Statler
in Matte Black
paired with
Metro
in Brushed Nickel



NEW COLLECTION
SPRING 2026

FEATURED IN BRUSHED NICKEL

View display board on p. 134



GALLOWAY AVAILABLE FINISHES, SIZES & PART NUMBERS



BRUSHED NICKEL

224mm CC	3092-1BPN-B
160mm CC	3091-1BPN-B
128mm CC	3090-1BPN-B
96mm CC	3089-1BPN-B
Knob	3093-1BPN-B



MATTE BLACK

224mm CC	3102-1055-B
160mm CC	3101-1055-B
128mm CC	3100-1055-B
96mm CC	3099-1055-B
Knob	3103-1055-B



MODERN BRUSHED GOLD

224mm CC	3097-1MDB-B
160mm CC	3096-1MDB-B
128mm CC	3095-1MDB-B
96mm CC	3094-1MDB-B
Knob	3098-1MDB-B



CC	PRODUCT TYPE	LENGTH	WIDTH	HEIGHT/ PROJECTION	HAND CLEARANCE	DIAMETER	BASE
224mm	Backplate	11 3/4in.	1 3/4in.	3/2in.	-	-	-
160mm	Backplate	8 2 1/2in.	1 3/4in.	3/2in.	-	-	-
128mm	Backplate	7 1 3/2in.	1 3/4in.	3/2in.	-	-	-
96mm	Backplate	6 3/2in.	1 3/4in.	3/2in.	-	-	-
-	Backplate	2 1 1/4in.	1 3/4in.	3/2in.	-	-	-

Collection Material: Zinc



NEW COLLECTION
SPRING 2026

FEATURED IN MATTE BLACK

View display board on p. 137



224mm CC



160mm CC



128mm CC



96mm CC



Knob

STATLER AVAILABLE FINISHES, SIZES & PART NUMBERS



BRUSHED NICKEL

224mm CC	3107-1BPN-B
160mm CC	3106-1BPN-B
128mm CC	3105-1BPN-B
96mm CC	3104-1BPN-B
Knob	3108-1BPN-B



MATTE BLACK

224mm CC	3117-1055-B
160mm CC	3116-1055-B
128mm CC	3115-1055-B
96mm CC	3114-1055-B
Knob	3118-1055-B



MODERN BRUSHED GOLD

224mm CC	3112-1MDB-B
160mm CC	3111-1MDB-B
128mm CC	3110-1MDB-B
96mm CC	3109-1MDB-B
Knob	3113-1MDB-B



CC	PRODUCT TYPE	LENGTH	WIDTH	HEIGHT/ PROJECTION	HAND CLEARANCE	DIAMETER	BASE
224mm	Backplate	9 7/8in.	1 3/4in.	3/8in.	-	-	-
160mm	Backplate	7 1/8in.	1 3/4in.	3/8in.	-	-	-
128mm	Backplate	6 3/8in.	1 3/4in.	3/8in.	-	-	-
96mm	Backplate	4 1/4in.	1 3/4in.	3/8in.	-	-	-
-	Backplate	3 7/8in.	1 3/4in.	3/8in.	-	-	-

Collection Material: Zinc



Prelude

COLLECTION AVAILABLE IN ALL FINISHES SHOWN

View display board on p. 139



BRUSHED NICKEL

4in. 8012-BPN-P



MATTE BLACK

4in. 8014-55-P



MODERN BRUSHED GOLD

4in. 8018-MDB-P



OIL RUBBED BRONZE

4in. 8015-ORB-P



POLISHED CHROME

4in. 8011-26-P



VERONA BRONZE

4in. 8016-VB-P



VINTAGE NICKEL

4in. 8019-VTN-P



CC	PRODUCT TYPE	LENGTH	WIDTH	HEIGHT/ PROJECTION	HAND CLEARANCE	DIAMETER	BASE	TAP/SCREWS (QTY)
-	Hook	4in.	3/8in.	3 1/16in.	-	-	1 1/16in.	5/16in. Wood (4)

Collection Material: Zinc



Ball Knob

NEW PRODUCTS
NOW AVAILABLE

SHOWN IN ALL AVAILABLE FINISHES



BALL KNOB AVAILABLE FINISHES & PART NUMBERS



BRUSHED NICKEL

Knob	3027-1BPN-P
------	-------------



MATTE BLACK

Knob	3029-1055-P
------	-------------



MODERN BRUSHED GOLD

Knob	3028-1MDB-P
------	-------------

CC	PRODUCT TYPE	LENGTH	WIDTH	HEIGHT/ PROJECTION	HAND CLEARANCE	DIAMETER	BASE	TAP/SCREWS (QTY)
-	Knob	-	-	1 1/2in.	-	3/2in.	1 1/2in.	8-32 x 1in. (1)

Collection Material: Zinc



Berenson Knobs

FEATURED IN AVAILABLE FINISHES



BERENSON KNOBS AVAILABLE FINISHES, STYLES & PART NUMBERS



CERAMIC WHITE

Knob 1	2880-539-P
--------	------------



MODERN BRUSHED GOLD

Knob 2	9714-1MDB-P
--------	-------------

CC	PRODUCT TYPE	LENGTH	WIDTH	HEIGHT/ PROJECTION	HAND CLEARANCE	DIAMETER	BASE	TAP/SCREWS (QTY)
-	Knob 1	-	-	1 1/2in.	-	1 3/8in.	5/8in.	8-32 x 1in. (1)
-	Knob 2	-	-	1 1/2in.	-	1 1/2in.	5/8in.	8-32 x 1in. (1)

Collection Material: Zinc



Finish Guide

Quickly reference Berenson finishes with the finish selection board.
Match our finishes to your projects with a convenient display board. Find it on page 141.



55 Black / Matte Black / Satin Black



BPN Brushed Nickel



MDB Modern Brushed Gold



26 Polished Chrome



VB Verona Bronze



VTN Vintage Nickel



Aluminum
ALU

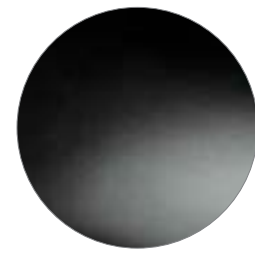

Black / Matte Black /
Satin Black
55

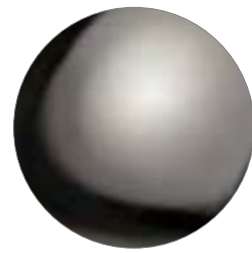

Black Nickel
98



Matte Black and
Brushed Nickel
55BPN

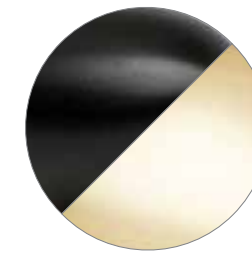

Matte Black and
Modern Brushed Gold
55MDB

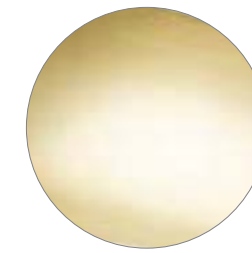

Modern Brushed Gold
MDB

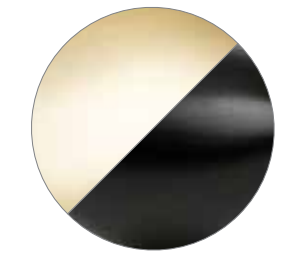

Modern Brushed Gold
and Matte Black
MDB55

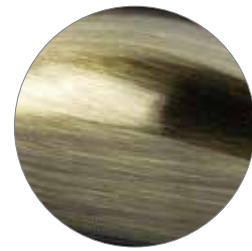

Brushed Antique Brass
BAB

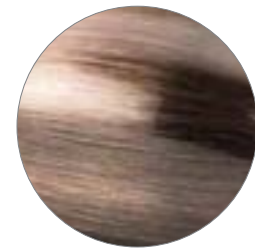

Brushed Antique Copper
BAC

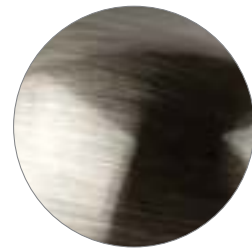

Brushed Black Nickel
BBN



Oil Rubbed Bronze
ORB



Polished Chrome
26



Polished Copper
PC



Polished Nickel
14

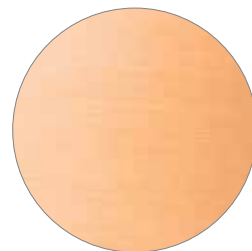

Brushed Copper
BC

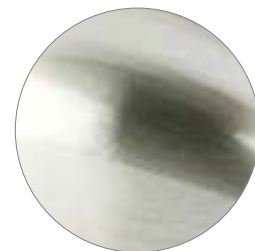

Brushed Nickel
BPN



Brushed Nickel and
Matte Black
BPN55

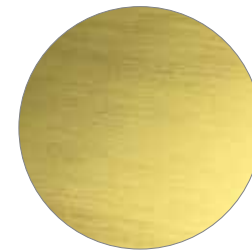

Satin Gold
SG



Slate
SLT

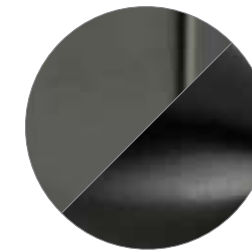

Slate and Matte Black
SLT55



Stainless Steel
SS

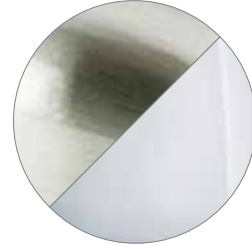

Brushed Nickel and
Polished Chrome
BPN26



Brushed Tin
BT



Graphite
GPH



Toasted Bronze
TB



Verona Bronze
VB



Vintage Nickel
VTN



Weathered Copper
WC

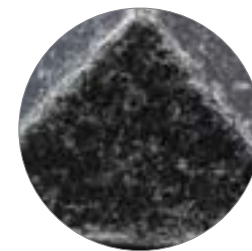







Weathered Iron
LWI



Weathered Verona Bronze
WVB

Suggested Pairings

Use this guide to complete your space by pairing Berenson's top finishes with popular plumbing and lighting brands.

BERENSON HARDWARE FINISHES	 BRUSHED NICKEL (BPN)	 POLISHED NICKEL (14)	 POLISHED CHROME (26)		BERENSON HARDWARE FINISHES	 MATTE BLACK (55)	 MODERN BRUSHED GOLD (MDB)	 VERONA BRONZE (VB)
PLUMBING								
KOHLER®	Stainless	Polished Nickel	Polished Chrome		KOHLER®	Matte Black	French Gold	Oil Rubbed Bronze
DELTA®	Stainless	Polished Nickel	Chrome		DELTA®	Matte Black	Champagne Bronze	Venetian Bronze
MOEN®	Brushed Nickel	Polished Nickel	Chrome		MOEN®	Matte Black	Brushed Gold	Mediterranean Bronze
BRIZO®	Stainless	Polished Nickel	Polished Chrome		BRIZO®	Matte Black	Luxe Gold	Venetian Bronze
PFISTER®	Stainless Steel	Polished Nickel	Polished Chrome		PFISTER®	Matte Black	Brushed Gold	Tuscan Bronze
ROHL®	Satin Nickel	Polished Nickel	Polished Chrome		ROHL®	Matte Black	Satin English Gold	Tuscan Bronze
LIGHTING								
CAPITAL®	Brushed Nickel	Polished Nickel	Chrome		CAPITAL®	Black	Matte Brass	Oil Rubbed Bronze
HINKLEY®	Brushed Nickel	Polished Nickel	Chrome		HINKLEY	Black	Lacquered Brass	Dark Brass
KICHLER®	Brushed Nickel	Polished Nickel	Chrome		KICHLER	Black	Brushed Natural Brass	Olde Bronze
PROGRESS	Brushed Nickel	Polished Nickel	Polished Chrome		PROGRESS	Matte Black	Brushed Bronze/Gold	Venetian Bronze

Featuring the Epoch Edge Collection
in Polished Chrome



Display Boards

DISPLAY BOARD OPTIONS

We offer display boards with and without printed part numbers.
You can tell which is which based on the part number for the board.

Display boards measure 11 13/16in. x 15 13/16in. x 1/8in.

-03 = NO PART NUMBERS



0578-7000-03-G • No part numbers printed on front

-05 = PART NUMBERS



0578-7000-05-G • Part numbers printed on front

PLANOGRAM STICKERS (POG)

Additional part information can be found on the Planogram (POG) sticker located on the back of Berenson and R. Christensen by Berenson display boards.

- Dots on the POG note the parts that are shown on the front of the board.

Info that can be found on the POG:

- CC Measurement
- Product Type
- Finish
- Part Number
- Price Code

ROQUE-01			0578-7000-03-G	
CC	Type	Finish	Part No.	Price Code
12in.	App. Pull	Black Nickel	8125-1098-P	E
224mm.	Pull	Black Nickel	8124-1098-P	E
160mm.	Pull	Black Nickel	8123-1098-P	E
128mm.	Pull	Black Nickel	8122-1098-P	D
• 96mm.	Pull	Black Nickel	8121-1098-P	D
	Knob	Black Nickel	8120-1098-P	C
12in.	App. Pull	Brushed Nickel	8101-1BPN-P	E
224mm.	Pull	Brushed Nickel	8100-1BPN-P	E
160mm.	Pull	Brushed Nickel	8099-1BPN-P	E
128mm.	Pull	Brushed Nickel	8098-1BPN-P	D
96mm.	Pull	Brushed Nickel	8097-1BPN-P	D
•	Knob	Brushed Nickel	8096-1BPN-P	C
12in.	App. Pull	Matte Black	8095-1055-P	E
224mm.	Pull	Matte Black	8094-1055-P	E
160mm.	Pull	Matte Black	8093-1055-P	E
128mm.	Pull	Matte Black	8092-1055-P	D
96mm.	Pull	Matte Black	8091-1055-P	D
•	Knob	Matte Black	8090-1055-P	C
12in.	App. Pull	Modern Brushed Gold	8107-1MDB-P	E
224mm.	Pull	Modern Brushed Gold	8106-1MDB-P	E
160mm.	Pull	Modern Brushed Gold	8105-1MDB-P	E
128mm.	Pull	Modern Brushed Gold	8104-1MDB-P	D
• 96mm.	Pull	Modern Brushed Gold	8103-1MDB-P	D
	Knob	Modern Brushed Gold	8102-1MDB-P	C

* Part shown on front of board.

0578-POG-01

Merchandising Options

Berenson offers a range of merchandising display options designed to showcase our hardware in a way that best fits your showroom and business needs.

Display Boards

CLASSIC COMFORT



Aspire - pg 7 0292-7000-05-G



Brookridge - pg 9 0541-7000-05-G



Domestic Bliss - pg 21 0270-7000-05-G



Euro Moderno - pg 23 0364-7000-05-G



Cannelee - pg 11 0645-7000-05-G



Connections - pg 13 0275-7000-05-G



Galloway - pg 119 0649-7000-05-G



Meadow - pg 25 0370-7000-05-G



Designers' Group Ten - pg 15 0280-7000-05-G



Dierdra - pg 17 0322-7000-05-G



Oasis - pg 27 0293-7000-05-G



Rivet Rebel - pg 29 0564-7000-05-G

Display Boards

CLASSIC COMFORT



Subtle Surge - pg 31

0478-7000-05-G



Tempo - pg 33

0377-7000-05-G

Display Boards

UPTOWN APPEAL



Bravo - pg 47

0270-7000-05-G



Elevate - pg 49

0369-7000-05-G



Featuring the Elevate Collection in Matte Black



Epoch Edge - pg 51

0479-7000-05-G



Fluidic - pg 53

0314-7000-05-G



Laura - pg 55

0323-7000-05-G



Metro - pg 59

0274-7000-05-G

Display Boards **UPTOWN APPEAL**



Radial Reign - pg 61 0565-7000-05-G



Roque - pg 67 0578-7000-05-G



Skyline - pg 69 0291-7000-05-G



Stainless Steel - pg 71 0217-70SS-05-G



Statler - pg 121 0648-7000-05-G



Studio - pg 72 0371-7000-05-G

Display Boards **UPTOWN APPEAL**



Studio Remix - pg 73 0643-7000-05-G



Swagger - pg 75 0378-7000-05-G

Display Boards **TIMELESS CHARM**



Echo - pg 87 0295-7000-05-G



Emerling - pg 89 0646-7000-05-G

Display Boards **TIMELESS CHARM**



Folklore - pg 93 0628-7000-05-G



Harmony - pg 95 0313-7000-05-G

Display Boards **TIMELESS CHARM**



Vibrato - pg 103 0204-70VB-05-G



Village - pg 105 0372-7000-05-G



Hearthstone - pg 97 0277-7000-05-G



Prelude - pg 123 0211-7000-05-G

Display Boards **ARTISAN INSPIRED**



Tailored Traditional - pg 99 0477-7000-05-G



Vested Interest - pg 101 0379-7000-05-G



Art Nouveau | Rhapsody - pg 115 & 116 0629-7000-05-G

Display Boards

FEATURED STYLES



Black and Gold 0199-7000-05



Contemporary Best Sellers - pg 45 0567-7000-05



Finish Selection - pg 127 0569-7000-05



Traditional Best Sellers - pg 85 0568-7000-05



Transitional Best Sellers - pg 5 0566-7000-05

Updated Board

Premium Boards

Premium display boards do not fit in tower displays.



Appliance Pull Premium Display Board 01
0520-6000-03

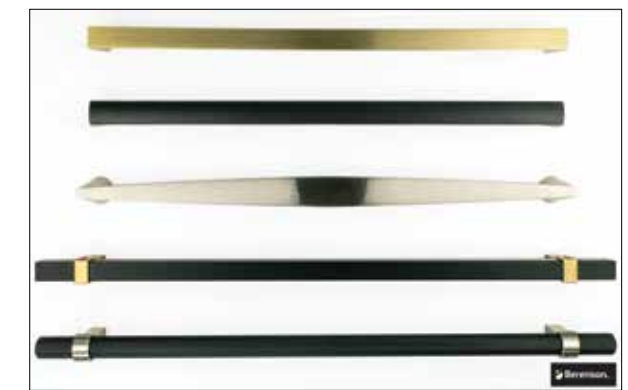

Appliance Pull Premium Display Board 02
0595-6000-03



Beauty Boards



PRICE CODE BEAUTY BOARD 0496-7000-02



SAMPLICITY BEAUTY BOARD 0585-7000-02



2026 NEW PRODUCTS BEAUTY BOARD 0650-7000-02



FOLKLORE BEAUTY BOARD 0631-7000-02

Display board artwork is subject to change at any time and may not reflect the image shown above. Beauty Boards contain printed IMAGES ONLY. NO HARDWARE INCLUDED ON BEAUTY BOARDS.

Display Towers

Scan the QR Code to access the Tower Order Form.

Berenson offers two different size towers for displaying our products, a 12-board option and a 36-board option. Each display tower rotates 360 degrees for easy access and comes with brand headers. Choose a standard selection of display boards or build a custom tower.



12-BOARD TOWER
0012-2000-01

Measures 19 3/4in. width by 81 1/16in. height and holds 12 display boards.



36-BOARD TOWER
0011-2000-01

Measures 34 7/8in. width by 81 1/16in. height and holds 36 display boards.

Display Accessories

BRAND HEADERS

Brand headers are available in three options: Berenson, Advantage Plus by Berenson and R. Christensen by Berenson. Each header is double-sided and can also be placed back to back for dual branding. The 12-board display tower has one header slot and the 36-board display tower has three header slots.

Brand headers measure 7 7/8in. x 15 1/16in. x 1/8in.



Berenson Header
0512-7000-02



Advantage Plus Header
0513-7000-02



R. Christensen Header
0514-7000-02

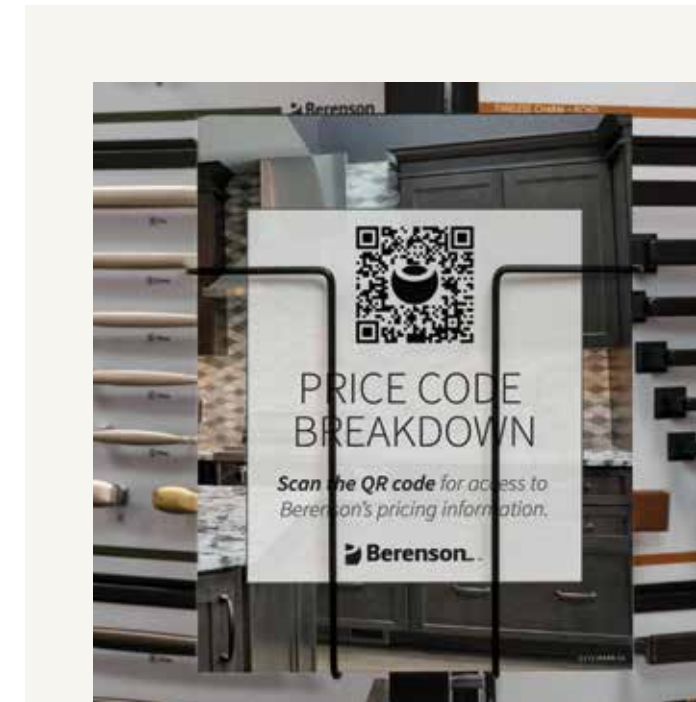

DISPLAY TOWER SHELF 0170-0KIT-01

Attaches right onto the tower!

This kit includes the Display Tower Shelf, Display Board Guide, the Price Code Guide, and assembly instructions.

Additional Marketing Materials, such as this catalog, can also be stored in the shelf.

For more information or to order contact:
Sales@BerensonHardware.com | 800.333.0578

Berenson Product Lines

For information on our additional lines, please contact Sales or scan the QR codes.
Sales@BerensonHardware.com | 800.333.0578



Featuring the Transitional Advantage Two Collection in Matte Black Design and photos by Jennifer Hutton at Artisan Kitchens and Baths, @JenniferHutton_Pro



Featuring the Fluid Collection in Polished Chrome

Advantage +Plus by Berenson

Advantage Plus by Berenson ensures everyone can complete the design of their beautiful home by offering cabinet hardware at an affordable price.

The 13 value collections featured in this line come in a variety of trending finishes and stylish designs.

This line also includes our popular Advantage Wire Pulls coming in four common sizes: 3in., 3 1/2in., 96mm and 4in—and a variety of popular finishes.



Display boards measure: 11 1/8in. x 15 1/8in. x 1/8in.

DISPLAY DETAILS

Our Advantage Plus by Berenson display boards are blue in color.

The price code, center to center measurement and part number can be found listed below each part on the display board.

There are **13 boards in the Advantage Plus line**, one for each collection.



R. Christensen by Berenson

R. Christensen by Berenson is our luxury line of decorative hardware, with most collections manufactured to meet ISO 14001 environmental standards.

Featuring the Art Tech Series, it offers sleek knobs and pulls with refined lines and smooth surfaces that elevate contemporary kitchens and baths.

Available in stylish finishes like Soft Gold and Charcoal Gray, as well as classics such as Brushed Nickel and Polished Chrome, the collections include a range of hardware types—from edge pulls to hooks—delivering a bold, elevated take on timeless design.



Display boards measure: 11 1/8in. x 15 1/8in. x 1/8in.

DISPLAY DETAILS

Our R. Christensen by Berenson display boards are white in color.

A selection of favorite Art Tech collections have been paired together to be featured on 8 stylish display boards.

These boards do not feature item numbers on the front and include recent additions such as Fluid, Mini, and our new finish, Rose Gold.





Featuring the Domestic Bliss Collection in Modern Brushed Gold Design and photos by Jennifer Hutton at Artisan Kitchens and Baths, @JenniferHutton_Pro

DETERMINING CENTER TO CENTER

Our pulls come in a range of sizes and are measured in either inches or millimeters. To determine the center to center (CC) of a pull, use a ruler to measure the distance between the centers of the screw holes.

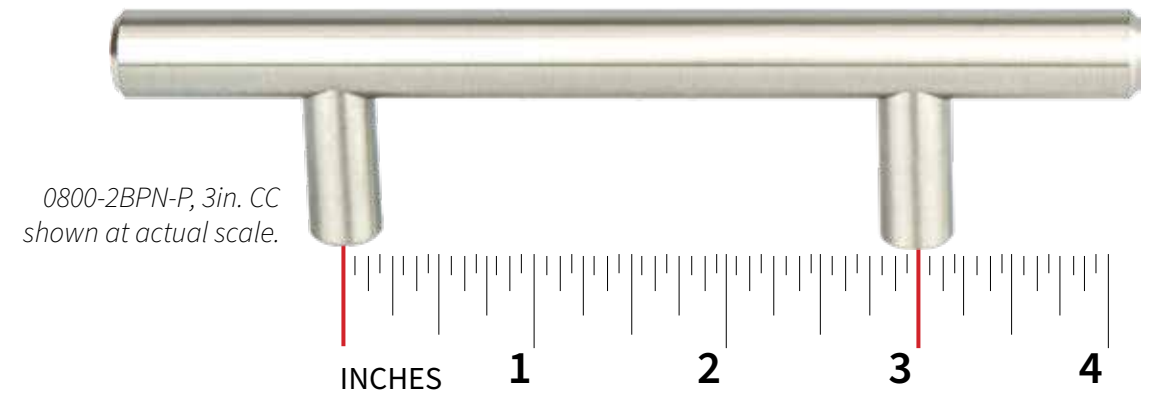

CC MEASUREMENT CONVERSION

Inches	Millimeters	Inches	Millimeters	Inches	Millimeters
1 1/4in.	32mm	6in.	152.4mm	15 1/2in.	384mm
2 3/16in.	56mm	6 5/16in.	160mm	16 3/8in.	416mm
2 1/2in.	64mm	6 21/32in.	169mm	17 21/32in.	448mm
3in.	76.2mm	7 9/16in.	192mm	18in.	457.2mm
3 1/2in.	83.9mm	8 13/16in.	224mm	21 13/32in.	544mm
3 25/32in.	96mm	10 1/16in.	256mm	25 7/32in.	640mm
4in.	101.6mm	11 11/32in.	288mm	26 25/32in.	672mm
4 13/32in.	112mm	12in.	304.8mm	30 7/32in.	768mm
5 1/16in.	128mm	12 19/32in.	320mm		

INSTALLING DECORATIVE HARDWARE FOR THE FIRST TIME

When you have decided where you want your hardware placed, use a ruler or cabinet hardware template to mark the drilling locations.

You'll want the placement to be the same across all cabinets for a consistent look. Once all the locations are marked you are ready to use your 3/16in. drill bit and drill the holes.

TOOLS REQUIRED:

- ① Ruler or Cabinet Hardware Template
- ② Power Drill

Where you place your hardware on a cabinet is entirely up to you. You can see some traditional placement of hardware to the right.

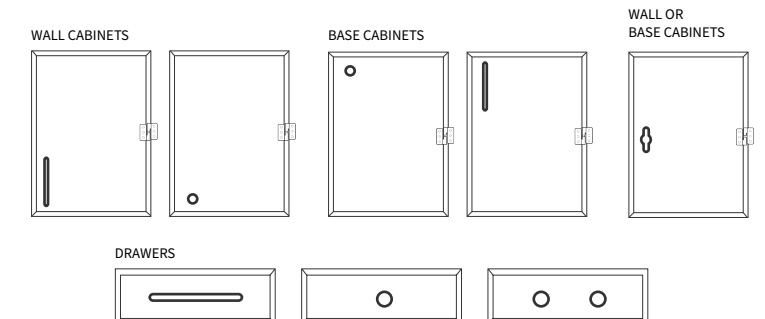

CC & Install Guide

Scan the QR code to visit our online conversion chart. Quickly find hardware in the size you need!

Featuring the Brookridge Collection
in Brushed Nickel



PART NUMBER BREAKDOWN

Parts Are Identified As Follows:

ITEM #: Four-digit item code
(followed by a dash)

MATERIAL: One-digit primary
material code

FINISH: Two-digit code or a character code
(two or three letters) to distinguish
the finish (followed by a dash)

PACKAGING: One-letter packaging code



EXAMPLE

Part Number:

2640-1BPN-P

ITEM # MATERIAL FINISH PACKAGING

Description of Above Example:
Zinc Diecast, Brushed Nickel,
Polybagged w/Mounting Hardware

KEY TO MATERIAL CODES

- 1 Zinc Diecast (Zamac)
- 2 Steel
- 4 Aluminum
- 9 Other (Stainless Steel or Crystal)

KEY TO FINISH CODES

See Pages 127-128 for Codes.

KEY TO PACKAGING CODES

- B** Item is supplied in bulk without mounting screws or escutcheon pins. (Mounting hardware ordered separately.)
- C** Item is supplied in a carton with 8-32 x 1 in. or M4 x 45mm break off screws.
- P** Item is individually polybagged with 8-32 x 1 in. screws or other mounting hardware.



Key to Codes

Our item numbers contain information on the hardware's finish and material.



PRICING BREAKDOWN

Scan the QR code for the most updated pricing brackets for codes A-E.

Part Index

Part No.	CC/Type	Page No.
0800-2BPN-P	3in.	33
0801-20VB-P	3in.	33
0802-2BPN-P	96mm	33
0803-20VB-P	96mm	33
0804-2BPN-P	128mm	33
0805-20VB-P	128mm	33
0806-2BPN-P	192mm	33
0807-20VB-P	192mm	33
0808-2BPN-P	256mm	33
0809-20VB-P	256mm	33
0810-2BPN-P	320mm	33
0811-20VB-P	320mm	33
0812-20VB-P	160mm	33
0813-20VB-P	224mm	33
0820-2MDB-P	3in.	33
0821-2MDB-P	96mm	33
0822-2MDB-P	128mm	33
0823-2MDB-P	160mm	33
0824-2MDB-P	192mm	33
0825-2MDB-P	224mm	33
0826-2MDB-P	256mm	33
0828-2MDB-P	320mm	33
0829-2MDB-P	Knob	33
0830-2055-P	3in.	33
0831-2055-P	96mm	33
0832-2055-P	128mm	33
0833-2055-P	160mm	33
0834-2055-P	192mm	33
0835-2055-P	224mm	33
0836-2055-P	256mm	33
0838-2055-P	320mm	33
0839-2055-P	Knob	33
1046-40BC-P	32mm	47
1047-40BC-P	56mm	47
1048-40BC-P	112mm	47
1049-40BC-P	169mm	47

Part No.	CC/Type	Page No.
1051-4ALU-B	Edge Pull	47
1052-4BPN-P	32mm	47
1053-4026-P	32mm	47
1055-40VB-P	32mm	47
1056-4055-P	32mm	47
1057-4BPN-P	56mm	47
1058-4026-P	56mm	47
1059-40VB-P	56mm	47
1060-4055-P	56mm	47
1061-4BPN-P	112mm	47
1062-4026-P	112mm	47
1063-40VB-P	112mm	47
1064-4055-P	112mm	47
1065-4BPN-P	169mm	47
1066-4026-P	169mm	47
1067-40VB-P	169mm	47
1068-4055-P	169mm	47
1069-40SG-P	32mm	47
1070-40SG-P	56mm	47
1071-40SG-P	112mm	47
1072-40SG-P	169mm	47
1073-4GPH-P	32mm	47
1074-4GPH-P	56mm	47
1075-4GPH-P	112mm	47
1076-4GPH-P	169mm	47
1114-1MDB-P	18in.	31
1115-1BPN-P	18in.	31
1116-1014-P	18in.	31
1117-10VB-P	18in.	31
1118-1VTN-P	18in.	31
1119-1055-P	18in.	31
1120-1026-P	320mm	69
1121-1SLT-P	3in. & 96mm	69
1122-1SLT-P	160mm	69
1123-1SLT-P	224mm	69
1124-1SLT-P	320mm	69

Part No.	CC/Type	Page No.
1125-1SLT-P	Knob	69
1126-2BPN-P	160mm	33
1127-2BPN-P	224mm	33
1128-2BPN-P	288mm	35
1129-2BPN-P	384mm	35
1130-2BPN-P	448mm	35
1131-2BPN-P	544mm	35
1132-2BPN-P	640mm	35
1133-2BPN-P	768mm	35
1200-1BPN-P	Knob	51
1201-10VB-P	Knob	51
1202-1026-P	Knob	51
1203-1055-P	Knob	51
1204-1MDB-P	Knob	51
1205-1VTN-P	Knob	51
1206-1BPN-P	96mm	51
1207-10VB-P	96mm	51
1208-1026-P	96mm	51
1209-1055-P	96mm	51
1210-1MDB-P	96mm	51
1211-1VTN-P	96mm	51
1212-1BPN-P	128mm	51
1213-10VB-P	128mm	51
1214-1026-P	128mm	51
1215-1055-P	128mm	51
1216-1MDB-P	128mm	51
1217-1VTN-P	128mm	51
1218-1BPN-P	160mm	51
1219-10VB-P	160mm	51
1220-1026-P	160mm	51
1221-1055-P	160mm	51
1222-1MDB-P	160mm	51
1223-1VTN-P	160mm	51
1224-1BPN-P	224mm	51
1225-10VB-P	224mm	51
1226-1026-P	224mm	51

Part No.	CC/Type	Page No.
1227-1055-P	224mm	51
1228-1MDB-P	224mm	51
1229-1VTN-P	224mm	51
1230-1BPN-P	12in.	51
1231-10VB-P	12in.	51
1232-1026-P	12in.	51
1233-1055-P	12in.	51
1234-1MDB-P	12in.	51
1235-1VTN-P	12in.	51
1236-1BPN-P	Knob	31
1237-10VB-P	Knob	31
1238-1014-P	Knob	31
1239-1055-P	Knob	31
1240-1MDB-P	Knob	31
1241-1VTN-P	Knob	31
1242-1BPN-P	96mm	31
1243-10VB-P	96mm	31
1244-1014-P	96mm	31
1245-1055-P	96mm	31
1246-1MDB-P	96mm	31
1247-1VTN-P	96mm	31
1248-1BPN-P	128mm	31
1249-10VB-P	128mm	31
1250-1014-P	128mm	31
1251-1055-P	128mm	31
1252-1MDB-P	128mm	31
1253-1VTN-P	128mm	31
1254-1BPN-P	160mm	31
1255-10VB-P	160mm	31
1256-1014-P	160mm	31
1257-1055-P	160mm	31
1258-1MDB-P	160mm	31
1259-1VTN-P	160mm	31
1260-1BPN-P	224mm	31
1261-10VB-P	224mm	31
1262-1014-P	224mm	31
1263-1055-P	224mm	31
1264-1MDB-P	224mm	31
1265-1VTN-P	224mm	31

Part No.	CC/Type	Page No.
1266-1BPN-P	12in.	31
1267-10VB-P	12in.	31
1268-1014-P	12in.	31
1269-1055-P	12in.	31
1270-1MDB-P	12in.	31
1271-1VTN-P	12in.	31
1272-1BPN-P	Knob	99
1273-10VB-P	Knob	99
1274-1014-P	Knob	99
1275-1055-P	Knob	99
1276-1MDB-P	Knob	99
1277-1VTN-P	Knob	99
1278-1BPN-P	96mm	99
1279-10VB-P	96mm	99
1280-1014-P	96mm	99
1281-1055-P	96mm	99
1282-1MDB-P	96mm	99
1283-1VTN-P	96mm	99
1284-1BPN-P	128mm	99
1285-10VB-P	128mm	99
1286-1014-P	128mm	99
1287-1055-P	128mm	99
1288-1MDB-P	128mm	99
1289-1VTN-P	128mm	99
1290-1BPN-P	160mm	99
1291-10VB-P	160mm	99
1292-1014-P	160mm	99
1293-1055-P	160mm	99
1294-1MDB-P	160mm	99
1295-1VTN-P	160mm	99
1296-1BPN-P	224mm	99
1297-10VB-P	224mm	99
1298-1014-P	224mm	99
1299-1055-P	224mm	99
1300-1MDB-P	224mm	99
1301-1VTN-P	224mm	99
1302-1BPN-P	12in.	99
1303-10VB-P	12in.	99
1304-1014-P	12in.	99

Part No.	CC/Type	Page No.
1305-1055-P	12in.	99
1306-1MDB-P	12in.	99
1307-1VTN-P	12in.	99
2006-2026-P	320mm	33
2010-90SS-P	96mm	72
2011-90SS-P	12in.	72
2012-2026-P	3in.	33
2013-2026-P	96mm	33
2014-2026-P	128mm	33
2015-2026-P	192mm	33
2016-2026-P	224mm	33
2017-2026-P	256mm	33
2018-20VB-P	Knob	33
2019-2026-P	Knob	33
2020-2BPN-P	Knob	33
2021-90SS-P	128mm	72
2022-90SS-P	160mm	72
2023-90SS-P	192mm	72
2024-90SS-P	224mm	72
2025-90SS-P	256mm	72
2026-90SS-P	288mm	72
2027-90SS-P	576mm	72
2028-2026-P	160mm	33
2029-10VB-P	96mm	7
2030-10VB-P	128mm	7
2031-10VB-P	160mm	7
2032-10VB-P	12in.	7
2033-10VB-P	Knob	7
2034-10VB-P	12in.	97
2035-1BPN-P	12in.	97
2036-1014-P	12in.	15
2037-1WVB-P	12in.	97
2038-1055-P	12in.	97
2039-10VB-P	128mm	97
2040-1BPN-P	128mm	97
2041-1014-P	128mm	15
2042-1WVB-P	128mm	97
2043-1055-P	128mm	97
2044-10VB-P	160mm	97

Part No.	CC/Type	Page No.	Part No.	CC/Type	Page No.	Part No.	CC/Type	Page No.	Part No.	CC/Type	Page No.	Part No.	CC/Type	Page No.	Part No.	CC/Type	Page No.
2045-1BPN-P	160mm	97	2109-4GPH-P	96mm	49	2147-1026-P	18in.	7	2187-955MDB-P	128mm	73	2295-4026-P	128mm	25	2333-1BPN-P	224mm	101
2046-1014-P	160mm	15	2110-4GPH-P	128mm	49	2148-1BPN-P	18in.	7	2188-9BPN26-P	160mm	73	2296-4026-P	160mm	25	2334-10VB-P	224mm	101
2047-1WVB-P	160mm	97	2111-4GPH-P	160mm	49	2149-10BT-P	18in.	7	2189-955BPN-P	160mm	73	2297-4026-P	256mm	25	2335-1BPN-P	12in.	101
2048-1055-P	160mm	97	2112-4GPH-P	256mm	49	2150-10VB-P	18in.	7	2190-9BPN55-P	160mm	73	2298-4026-P	320mm	25	2336-10VB-P	12in.	101
2075-1BPN-P	3in.	105	2113-4GPH-P	320mm	49	2151-1MDB-P	3in.	97	2191-9MDB55-P	160mm	73	2299-4026-P	448mm	25	2337-1BPN-P	Knob	101
2076-10VB-P	3in.	105	2114-4GPH-P	18in.	49	2152-1MDB-P	96mm	97	2192-955MDB-P	160mm	73	2300-4026-P	Knob	25	2338-10VB-P	Knob	101
2077-1BPN-P	96mm	105	2115-4GPH-P	Knob	49	2153-1MDB-P	128mm	97	2193-9BPN26-P	192mm	73	2301-40VB-P	448mm	25	2339-1BPN-P	96mm	21
2078-10VB-P	96mm	105	2116-4055-P	96mm	49	2154-1MDB-P	160mm	97	2194-955BPN-P	192mm	73	2302-4BPN-P	448mm	25	2340-10VB-P	96mm	21
2079-1BPN-P	128mm	105	2117-4055-P	128mm	49	2155-1MDB-P	6in.	97	2195-9BPN55-P	192mm	73	2303-40VB-P	128mm	25	2341-1014-P	96mm	21
2080-10VB-P	128mm	105	2118-4055-P	160mm	49	2156-1MDB-P	12in.	97	2196-9MDB55-P	192mm	73	2304-4BPN-P	160mm	25	2342-1MDB-P	96mm	21
2081-1BPN-P	160mm	105	2119-4055-P	256mm	49	2157-1MDB-P	18in.	97	2197-955MDB-P	192mm	73	2305-40VB-P	160mm	25	2343-1BPN-P	128mm	21
2082-10VB-P	160mm	105	2120-4055-P	320mm	49	2158-1MDB-P	Knob	97	2198-9BPN26-P	12in.	73	2306-4BPN-P	256mm	25	2344-10VB-P	128mm	21
2083-1BPN-P	256mm	105	2121-4055-P	18in.	49	2159-1VTN-P	3in.	97	2199-955BPN-P	12in.	73	2307-40VB-P	256mm	25	2346-1014-P	128mm	21
2084-10VB-P	256mm	105	2122-4055-P	Knob	49	2160-1VTN-P	96mm	97	2200-9BPN55-P	12in.	73	2308-4BPN-P	320mm	25	2347-1MDB-P	128mm	21
2085-4BPN-P	96mm	49	2123-4026-P	96mm	49	2161-1VTN-P	128mm	97	2201-9MDB55-P	12in.	73	2309-40VB-P	320mm	25	2348-1BPN-P	160mm	21
2086-40VB-P	96mm	49	2124-4026-P	128mm	49	2162-1VTN-P	160mm	97	2202-955MDB-P	12in.	73	2310-1BPN-P	Knob	25	2349-10VB-P	160mm	21
2087-4BPN-P	128mm	49	2125-4026-P	160mm	49	2163-1VTN-P	6in.	97	2273-40SG-P	96mm	25	2311-10VB-P	Knob	25	2350-1014-P	160mm	21
2088-40VB-P	128mm	49	2126-4026-P	256mm	49	2164-1VTN-P	12in.	97	2274-40SG-P	128mm	25	2312-1BPN-P	128mm	75	2351-1MDB-P	160mm	21
2089-4BPN-P	160mm	49	2127-4026-P	320mm	49	2165-1VTN-P	18in.	97	2275-40SG-P	160mm	25	2313-1026-P	128mm	75	2352-1BPN-P	224mm	21
2090-40VB-P	160mm	49	2128-4026-P	18in.	49	2166-1VTN-P	Knob	97	2276-40SG-P	256mm	25	2314-1098-P	128mm	75	2353-10VB-P	224mm	21
2091-4BPN-P	256mm	49	2129-4026-P	Knob	49	2167-10VB-P	18in.	97	2277-40SG-P	320mm	25	2315-1BPN-P	160mm	75	2354-1014-P	224mm	21
2092-40VB-P	256mm	49	2130-1MDB-P	96mm	7	2168-1BPN-P	18in.	97	2278-40SG-P	448mm	25	2316-1026-P	160mm	75	2355-1MDB-P	224mm	21
2093-4BPN-P	320mm	49	2131-1MDB-P	128mm	7	2169-1055-P	18in.	97	2279-40SG-P	Knob	25	2317-1098-P	160mm	75	2356-1BPN-P	320mm	21
2094-40VB-P	320mm	49	2132-1MDB-P	160mm	7	2172-1BPN-P	Knob	49	2280-4GPH-P	96mm	25	2318-1BPN-P	224mm	75	2357-10VB-P	320mm	21
2095-4BPN-P	Knob	49	2133-1MDB-P	12in.	7	2173-10SG-P	Knob	49	2281-4GPH-P	128mm	25	2319-1026-P	224mm	75	2358-1014-P	320mm	21
2096-40VB-P	Knob	49	2134-1MDB-P	18in.	7	2174-1GPH-P	Knob	49	2282-4GPH-P	160mm	25	2320-1098-P	224mm	75	2359-1MDB-P	320mm	21
2097-4BPN-P	96mm	25	2135-1MDB-P	Knob	7	2175-1055-P	Knob	49	2283-4GPH-P	256mm	25	2321-1BPN-P	320mm	75	2360-1BPN-P	Knob	21
2098-40VB-P	96mm	25	2136-1055-P	96mm	7	2176-1026-P	Knob	49	2284-4GPH-P	320mm	25	2322-1026-P	320mm	75	2361-10VB-P	Knob	21
2099-4BPN-P	128mm	25	2137-1055-P	128mm	7	2177-10VB-P	Knob	49	2285-4GPH-P	448mm	25	2323-1098-P	320mm	75	2362-1014-P	Knob	21
2100-40VB-P	18in.	49	2138-1055-P	160mm	7	2178-9BPN26-P	96mm	73	2286-4GPH-P	Knob	25	2324-1BPN-P	Knob	75	2363-1MDB-P	Knob	21
2101-4BPN-P	18in.	49	2139-1055-P	12in.	7	2179-955BPN-P	96mm	73	2287-4055-P	96mm	25	2325-1026-P	Knob	75	2364-1MDB-P	128mm	75
2102-40SG-P	96mm	49	2140-1055-P	18in.	7	2180-9BPN55-P	96mm	73	2288-4055-P	128mm	25	2326-1098-P	Knob	75	2365-1MDB-P	160mm	75
2103-40SG-P	128mm	49	2141-1055-P	Knob	7	2181-9MDB55-P	96mm	73	2289-4055-P	160mm	25	2327-1BPN-P	96mm	101	2366-1MDB-P	224mm	75
2104-40SG-P	160mm	49	2142-10BC-P	96mm	7	2182-955MDB-P	96mm	73	2290-4055-P	256mm	25	2328-10VB-P	96mm	101	2367-1MDB-P	320mm	75
2105-40SG-P	256mm	49	2143-10BC-P	128mm	7	2183-9BPN26-P	128mm	73	2291-4055-P	320mm	25	2329-1BPN-P	128mm	101	2368-1MDB-P	Knob	75
2106-40SG-P	320mm	49	2144-10BC-P	160mm	7	2184-955BPN-P	128mm	73	2292-4055-P	448mm	25	2330-10VB-P	128mm	101	2369-1VTN-P	96mm	101
2107-40SG-P	18in.	49	2145-10BC-P	12in.	7	2185-9BPN55-P	128mm	73	2293-4055-P	Knob	25	2331-1BPN-P	160mm	101	2370-1VTN-P	128mm	101
2108-40SG-P	Knob	49	2146-10BC-P	Knob	7	2186-9MDB55-P	128mm	73	2294-4026-P	96mm	25	2332-10VB-P	160mm	101	2371-1VTN-P	160mm	101

Part No.	CC/Type	Page No.
2372-1VTN-P	224mm	101
2373-1VTN-P	12in.	101
2374-1VTN-P	Knob	101
2381-10BC-P	128mm	21
2383-10BC-P	Knob	21
2385-1098-P	96mm	75
2386-1BPN-P	96mm	75
2387-1MDB-P	96mm	75
2388-1026-P	96mm	75
2389-1SLT-P	Knob	75
2390-1SLT-P	96mm	75
2391-1SLT-P	128mm	75
2392-1SLT-P	160mm	75
2393-1SLT-P	224mm	75
2394-1055-P	Knob	75
2395-1055-P	96mm	75
2396-1055-P	128mm	75
2397-1055-P	160mm	75
2398-1055-P	224mm	75
2399-1055-P	Knob	21
2400-1055-P	96mm	21
2401-1055-P	128mm	21
2402-1055-P	160mm	21
2403-1SLT-P	Knob	21
2404-1SLT-P	96mm	21
2405-1SLT-P	128mm	21
2406-1SLT-P	160mm	21
2407-1SLT-P	224mm	21
2408-1055-P	320mm	21
2409-1055-P	224mm	21
2410-1055-P	320mm	21
2411-1055-P	320mm	75
2412-1SLT-P	320mm	75
2413-1BPN-P	18in.	75
2415-1MDB-P	18in.	75
2416-1098-P	18in.	75
2417-1055-P	18in.	75
2419-1BPN-P	18in.	21

Part No.	CC/Type	Page No.
2420-1055-P	18in.	21
2421-1MDB-P	18in.	21
2422-10BC-P	96mm	21
2423-10BC-P	160mm	21
2424-10BC-P	224mm	21
2425-10BC-P	320mm	21
2426-10TB-P	Knob	21
2427-10TB-P	96mm	21
2428-10TB-P	128mm	21
2429-10TB-P	160mm	21
2432-10TB-P	224mm	21
2433-10TB-P	320mm	21
2446-1BPN-P	Knob	89
2447-1055-P	Knob	89
2448-1MDB-P	Knob	89
2449-1BPN-P	96mm	89
2450-1055-P	96mm	89
2451-1MDB-P	96mm	89
2452-1BPN-P	128mm	89
2453-1055-P	128mm	89
2454-1MDB-P	128mm	89
2455-1BPN-P	160mm	89
2456-1055-P	160mm	89
2457-1MDB-P	160mm	89
2458-1BPN-P	224mm	89
2459-1055-P	224mm	89
2460-1MDB-P	224mm	89
2461-1BPN-P	12in.	89
2462-1055-P	12in.	89
2463-1MDB-P	12in.	89
2464-1BPN-P	96mm	89
2465-1055-P	96mm	89
2466-1MDB-P	96mm	89
2615-1BPN-P	96mm	9
2616-1055-P	96mm	9
2617-10VB-P	96mm	9
2619-MDB-P	96mm	9
2620-1BPN-P	128mm	9

Part No.	CC/Type	Page No.
2621-1055-P	128mm	9
2622-10VB-P	128mm	9
2624-1MDB-P	128mm	9
2625-1BPN-P	160mm	9
2626-1055-P	160mm	9
2627-10VB-P	160mm	9
2629-1MDB-P	160mm	9
2630-1BPN-P	224mm	9
2631-1055-P	224mm	9
2632-10VB-P	224mm	9
2634-1MDB-P	224mm	9
2635-1BPN-P	12in.	9
2636-1055-P	12in.	9
2637-10VB-P	12in.	9
2639-1MDB-P	12in.	9
2640-1BPN-P	Knob	9
2641-1055-P	Knob	9
2642-10VB-P	Knob	9
2644-1MDB-P	Knob	9
2645-1BPN-P	Knob	9
2646-1055-P	Knob	9
2647-10VB-P	Knob	9
2649-1MDB-P	Knob	9
2650-1026-P	96mm	9
2651-1026-P	128mm	9
2652-1026-P	160mm	9
2653-1026-P	224mm	9
2654-1026-P	12in.	9
2655-1026-P	Knob	9
2656-1026-P	Knob	9
2657-1BPN-P	18in.	9
2658-1055-P	18in.	9
2659-1MDB-P	18in.	9
2880-539-P	Knob	126
2882-1BPN-P	Knob	11
2883-1055-P	Knob	11
2884-1MDB-P	Knob	11
2885-1BPN-P	96mm	11

Part No.	CC/Type	Page No.
2886-1055-P	96mm	11
2887-1MDB-P	96mm	11
2888-1BPN-P	128mm	11
2889-1055-P	128mm	11
2890-1MDB-P	128mm	11
2891-1BPN-P	160mm	11
2892-1055-P	160mm	11
2893-1MDB-P	160mm	11
2894-1BPN-P	224mm	11
2895-1055-P	224mm	11
2896-1MDB-P	224mm	11
2897-1BPN-P	12in.	11
2898-1055-P	12in.	11
2899-1MDB-P	12in.	11
3027-1BPN-P	Knob	125
3028-1MDB-P	Knob	125
3029-1055-P	Knob	125
3040-155-P	128mm	116
3041-1LWI-P	128mm	116
3043-155-P	96mm	116
3044-1LWI-P	96mm	116
3046-155-P	Knob	116
3047-1LWI-P	Knob	116
3049-155-P	Knob	116
3050-1LWI-P	Knob	116
3052-155-P	Knob	116
3053-1LWI-P	Knob	116
3055-155-P	Knob	116
3089-1BPN-B	96mm	119
3090-1BPN-B	128mm	119
3091-1BPN-B	160mm	119
3092-1BPN-B	224mm	119
3094-1BPN-B	Knob	119
3094-1MDB-B	96mm	119
3095-1MDB-B	128mm	119
3096-1MDB-B	160mm	119
3097-1MDB-B	224mm	119
3098-1MDB-B	Knob	119

Part No.	CC/Type	Page No.
3099-1055-B	96mm	119
3100-1055-B	128mm	119
3101-1055-B	160mm	119
3102-1055-B	224mm	119
3103-1055-B	Knob	119
3104-1BPN-B	96mm	121
3105-1BPN-B	128mm	121
3106-1BPN-B	160mm	121
3107-1BPN-B	224mm	121
3108-1BPN-B	Knob	121
3109-1MDB-B	96mm	121
3110-1MDB-B	128mm	121
3111-1MDB-B	160mm	121
3112-1MDB-B	224mm	121
3113-1MDB-B	Knob	121
3114-1055-B	96mm	121
3115-1055-B	128mm	121
3116-1055-B	160mm	121
3117-1055-B	224mm	121
3118-1055-B	Knob	121
4001-1VTN-P	3in.	13
4002-1055-P	3in.	13
4003-10VB-P	3in.	13
4004-1VTN-P	160mm	13
4005-1055-P	160mm	13
4006-10VB-P	160mm	13
4007-1VTN-P	Knob	13
4008-1055-P	Knob	13
4009-10VB-P	Knob	13
4011-10VB-P	96mm	115
4012-1VTN-P	96mm	115
4014-10VB-P	128mm	115
4015-1VTN-P	128mm	115
4017-10VB-P	Knob	115
4018-1VTN-P	Knob	115
4056-1BPN-P	96mm	17
4061-1BPN-P	Knob	17
4063-10VB-P	3in.	97

Part No.	CC/Type	Page No.
4064-1BPN-P	3in.	97
4067-1WVB-P	3in.	97
4068-1055-P	3in.	97
4069-10VB-P	96mm	97
4070-1BPN-P	96mm	97
4072-1BPN-P	96mm	55
4073-1WVB-P	96mm	97
4074-1055-P	96mm	97
4075-10VB-P	6in.	97
4076-1BPN-P	6in.	97
4077-1BPN-P	128mm	55
4079-1WVB-P	6in.	97
4080-1055-P	6in.	97
4081-10VB-P	Knob	97
4083-1BPN-P	Knob	97
4084-1026-P	96mm	55
4085-1WVB-P	Knob	97
4086-1055-P	Knob	97
4087-1026-P	128mm	55
4088-1BPN-P	Knob	55
4090-1026-P	Knob	55
4107-1014-P	96mm	17
4108-1BPN-P	96mm	59
4109-1026-P	96mm	59
4110-1014-P	Knob	17
4111-1055-P	96mm	59
4113-1BPN-P	128mm	59
4114-1026-P	128mm	59
4116-1055-P	128mm	59
4118-1BPN-P	160mm	59
4119-1026-P	160mm	59
4121-1055-P	160mm	59
4122-1BPN-P	Knob	59
4124-1026-P	Knob	59
4126-1055-P	Knob	59
4130-1VTN-P	96mm	13
4131-1055-P	96mm	13
4132-10VB-P	96mm	13

Part No.	CC/Type	Page No.	Part No.	CC/Type	Page No.	Part No.	CC/Type	Page No.	Part No.	CC/Type	Page No.	Part No.	CC/Type	Page No.	Part No.	CC/Type	Page No.
4134-10VB-P	3in. & 3½in.	115	4190-10TB-P	320mm	59	5043-4SLT-P	96mm	64	5081-4BPN-P	160mm	29	5119-455BPN-P	12in.	29	7077-9SS-C	288mm	71
4135-1VTN-P	3in. & 3½in.	115	4191-10TB-P	96mm	59	5044-4SLT-P	128mm	64	5082-4BPN-P	224mm	29	5120-4BPN55-P	Knob	29	7078-9SS-C	Knob	71
4139-1014-P	3in.	15	4192-10TB-P	Knob	59	5045-4SLT-P	160mm	64	5083-4BPN-P	12in.	29	5121-4BPN55-P	96mm	29	7079-9SS-C	Knob	71
4140-1014-P	96mm	15	4193-1BPN-P	12in.	55	5046-4SLT-P	224mm	64	5084-4026-P	Knob	29	5122-4BPN55-P	128mm	29	7876-1VB-P	3in.	103
4141-1014-P	6in.	15	4194-1MDB-P	12in.	55	5047-4SLT-P	12in.	64	5085-4026-P	96mm	29	5123-4BPN55-P	160mm	29	7878-1VB-P	Knob	103
4142-1014-P	Knob	15	4195-1026-P	12in.	55	5048-4MDB-P	Knob	64	5086-4026-P	128mm	29	5124-4BPN55-P	224mm	29	7883-1VB-P	128mm	103
4143-1014-P	Knob	15	4196-1VTN-P	12in.	55	5049-4MDB-P	96mm	64	5087-4026-P	160mm	29	5125-4BPN55-P	12in.	29	7886-1VB-P	64mm	103
4144-1014-P	96mm	15	4207-1055-P	Knob	55	5050-4MDB-P	128mm	64	5088-4026-P	224mm	29	5126-4SLT55-P	Knob	29	7890-1VB-P	96mm	103
4145-1014-P	Knob	15	4208-1055-P	96mm	55	5051-4MDB-P	160mm	64	5089-4026-P	12in.	29	5127-4SLT55-P	96mm	29	7895-1VB-P	Knob	103
4146-1014-P	3in.	15	4209-1055-P	128mm	55	5052-4MDB-P	224mm	64	5090-4055-P	Knob	29	5128-4SLT55-P	128mm	29	7897-1VB-P	Knob	103
4147-1014-P	4in.	15	4210-1055-P	160mm	55	5053-4MDB-P	12in.	64	5091-4055-P	96mm	29	5129-4SLT55-P	160mm	29	7898-1VB-P	3in.	103
4148-1014-P	3in.	15	4211-1055-P	224mm	55	5054-455MDB-P	Knob	61	5092-4055-P	128mm	29	5130-4SLT55-P	224mm	29	7899-1VB-P	Knob	103
4149-1014-P	6in.	15	4212-1055-P	12in.	55	5055-455MDB-P	96mm	61	5093-4055-P	160mm	29	5131-4SLT55-P	12in.	29	7900-1VB-P	3in.	103
4150-1014-P	Knob	15	4213-10TB-P	Knob	17	5056-455MDB-P	128mm	61	5094-4055-P	224mm	29	5132-455MDB-P	18in.	29	7901-1VB-P	3in.	103
4152-1014-P	Knob	15	4214-10TB-P	96mm	17	5057-455MDB-P	160mm	61	5095-4055-P	12in.	29	5133-4BPN-P	18in.	29	7904-1VB-P	128mm	103
4153-1014-P	96mm	15	4215-10TB-P	128mm	17	5058-455MDB-P	224mm	61	5096-4SLT-P	Knob	29	5134-4055-P	18in.	29	7905-1VB-P	96mm	103
4154-1014-P	18in.	15	4216-10TB-P	160mm	17	5059-455MDB-P	12in.	61	5097-4SLT-P	96mm	29	5135-4MDB-P	18in.	29	7906-1VB-P	Knob	103
4157-1055-P	96mm	17	4217-10TB-P	224mm	17	5060-455BPN-P	Knob	61	5098-4SLT-P	128mm	29	5136-4BPN-P	18in.	61	8011-26-P	Hook	123
4158-1055-P	Knob	17	4218-10TB-P	12in.	17	5061-455BPN-P	96mm	61	5099-4SLT-P	160mm	29	5137-4055-P	18in.	61	8012-BPN-P	Hook	123
4160-1MDB-P	96mm	17	5024-4BPN-P	Knob	61	5062-455BPN-P	128mm	61	5100-4SLT-P	224mm	29	5138-455MDB-P	18in.	61	8014-53-P	Hook	123
4162-1MDB-P	Knob	17	5025-4BPN-P	96mm	61	5063-455BPN-P	160mm	61	5101-4SLT-P	12in.	29	5139-4MDB-P	18in.	61	8015-ORB-P	Hook	123
4163-1MDB-P	128mm	17	5026-4BPN-P	128mm	61	5064-455BPN-P	224mm	61	5102-4MDB-P	Knob	29	5140-455BPN-P	18in.	61	8016-VB-P	Hook	123
4164-1MDB-P	160mm	17	5027-4BPN-P	160mm	61	5065-455BPN-P	12in.	61	5103-4MDB-P	96mm	29	5141-4MDB55-P	Knob	64	8018-MDB-P	Hook	123
4165-1MDB-P	224mm	17	5028-4BPN-P	224mm	61	5066-4BPN55-P	Knob	61	5104-4MDB-P	128mm	29	5142-4MDB55-P	96mm	64	8019-VTN-P	Hook	123
4166-1MDB-P	12in.	17	5029-4BPN-P	12in.	61	5067-4BPN55-P	96mm	61	5105-4MDB-P	160mm	29	5143-4MDB55-P	128mm	64	8090-1055-P	Knob	67
4167-1055-P	128mm	17	5030-4026-P	Knob	64	5068-4BPN55-P	128mm	61	5106-4MDB-P	224mm	29	5144-4MDB55-P	160mm	64	8091-1055-P	96mm	67
4168-1055-P	160mm	17	5031-4026-P	96mm	64	5069-4BPN55-P	160mm	61	5107-4MDB-P	12in.	29	5145-4MDB55-P	224mm	64	8092-1055-P	128mm	67
4169-1055-P	224mm	17	5032-4026-P	128mm	64	5070-4BPN55-P	224mm	61	5108-455MDB-P	Knob	29	5146-4MDB55-P	12in.	64	8093-1055-P	160mm	67
4172-1055-P	12in.	17	5033-4026-P	160mm	64	5071-4BPN55-P	12in.	61	5109-455MDB-P	96mm	29	7067-9SS-C	672mm	71	8094-1055-P	224mm	67
4180-10PC-P	96mm	59	5034-4026-P	224mm	64	5072-4098-P	Knob	61	5110-455MDB-P	128mm	29	7068-9SS-C	128mm	71	8095-1055-P	12in.	67
4181-10PC-P	128mm	59	5035-4026-P	12in.	64	5073-4098-P	96mm	61	5111-455MDB-P	160mm	29	7069-9SS-C	160mm	71	8096-1BPN-P	Knob	67
4182-10PC-P	160mm	59	5036-4055-P	Knob	61	5074-4098-P	128mm	61	5112-455MDB-P	224mm	29	7070-9SS-C	224mm	71	8097-1BPN-P	96mm	67
4183-10PC-P	224mm	59	5037-4055-P	96mm	61	5075-4098-P	160mm	61	5113-455MDB-P	12in.	29	7071-9SS-C	288mm	71	8098-1BPN-P	128mm	67
4184-10PC-P	320mm	59	5038-4055-P	128mm	61	5076-4098-P	224mm	61	5114-455BPN-P	Knob	29	7072-9SS-C	384mm	71	8099-1BPN-P	160mm	67
4185-10PC-P	Knob	59	5039-4055-P	160mm	61	5077-4098-P	12in.	61	5115-455BPN-P	96mm	29	7073-9SS-C	448mm	71	8100-1BPN-P	224mm	67
4187-10TB-P	128mm	59	5040-4055-P	224mm	61	5078-4BPN-P	Knob	29	5116-455BPN-P	128mm	29	7074-9SS-C	96mm	71	8101-1BPN-P	12in.	67
4188-10TB-P	160mm	59	5041-4055-P	12in.	61	5079-4BPN-P	96mm	29	5117-455BPN-P	160mm	29	7075-9SS-C	96mm	71	8102-1MDB-P	Knob	67
4189-10TB-P	224mm	59	5042-4SLT-P	Knob	64	5080-4BPN-P	128mm	29	5118-455BPN-P	224mm	29	7076-9SS-C	128mm	71	8103-1MDB-P	96mm	67

Part No.	CC/Type	Page No.	Part No.	CC/Type	Page No.	Part No.	CC/Type	Page No.	Part No.	CC/Type	Page No.	Part No.	CC/Type	Page No.	Part No.	CC/Type	Page No.
8104-1MDB-P	128mm	67	8318-1BPN-P	224mm	93	9156-10VB-P	128mm	87	9235-10BT-P	128mm	7	9456-1BPN-P	160mm	95	9814-1MDB-P	96mm	55
8105-1MDB-P	160mm	67	8319-1BPN-P	12in.	93	9157-10VB-P	160mm	87	9236-1026-P	160mm	7	9461-10VB-P	Knob	95	9815-1MDB-P	128mm	55
8106-1MDB-P	224mm	67	8326-10WC-P	Knob	93	9158-10VB-P	224mm	87	9237-1BPN-P	160mm	7	9462-1BPN-P	Knob	95	9816-1MDB-P	160mm	55
8107-1MDB-P	12in.	67	8327-10WC-P	96mm	93	9159-10VB-P	12in.	87	9238-10BT-P	160mm	7	9475-1026-P	96mm	53	9817-1MDB-P	224mm	55
8108-1VTN-P	Knob	67	8328-10WC-P	128mm	93	9161-1MDB-P	Knob	87	9239-1026-P	12in.	7	9476-1BPN-P	96mm	53	9818-1MDB-P	Knob	55
8109-1VTN-P	96mm	67	8329-10WC-P	160mm	93	9162-1MDB-P	3in.	87	9240-1BPN-P	12in.	7	9477-1026-P	128mm	53	9819-1026-P	160mm	55
8110-1VTN-P	128mm	67	8330-10WC-P	224mm	93	9163-1MDB-P	96mm	87	9241-10BT-P	12in.	7	9478-1BPN-P	128mm	53	9820-1026-P	224mm	55
8111-1VTN-P	160mm	67	8331-10WC-P	12in.	93	9164-1MDB-P	128mm	87	9242-1026-P	Knob	7	9479-1026-P	Knob	53	9821-1VTN-P	96mm	55
8112-1VTN-P	224mm	67	8332-10TB-P	Knob	93	9165-1MDB-P	160mm	87	9243-1BPN-P	Knob	7	9480-1BPN-P	Knob	53	9822-1VTN-P	128mm	55
8113-1VTN-P	12in.	67	8333-10TB-P	96mm	93	9166-1MDB-P	224mm	87	9244-10BT-P	Knob	7	9562-1BPN-P	160mm	17	9823-1VTN-P	160mm	55
8114-1026-P	Knob	67	8334-10TB-P	128mm	93	9167-1MDB-P	12in.	87	9245-1ORB-P	96mm	27	9564-1BPN-P	224mm	17	9824-1VTN-P	224mm	55
8115-1026-P	96mm	67	8335-10TB-P	160mm	93	9168-1MDB-P	18in.	87	9246-1BPN-P	96mm	27	9567-1014-P	160mm	17	9827-1VTN-P	Knob	55
8116-1026-P	128mm	67	8336-10TB-P	224mm	93	9200-1BPN-P	3in. & 96mm	69	9247-10BT-P	96mm	27	9568-1014-P	224mm	17	9828-1BPN-P	224mm	59
8117-1026-P	160mm	67	8337-10TB-P	12in.	93	9201-1026-P	3in. & 96mm	69	9248-1ORB-P	128mm	27	9576-1VTN-P	3in.	95	9835-1014-P	128mm	17
8118-1026-P	224mm	67	8338-10TB-P	3in.	93	9202-1055-P	3in. & 96mm	69	9249-1BPN-P	128mm	27	9577-1VTN-P	96mm	95	9852-1014-P	12in.	17
8119-1026-P	12in.	67	8339-10WC-P	3in.	93	9203-1BPN-P	160mm	69	9250-10BT-P	128mm	27	9578-1VTN-P	128mm	95	9853-1BPN-P	128mm	17
8120-1098-P	Knob	67	8340-1BPN-P	3in.	93	9204-1026-P	160mm	69	9251-1ORB-P	160mm	27	9579-1VTN-P	160mm	95	9854-1BPN-P	12in.	17
8121-1098-P	96mm	67	8341-1BPN-P	18in.	93	9205-1055-P	160mm	69	9252-1BPN-P	160mm	27	9580-1VTN-P	Knob	95	9857-1BPN-P	320mm	59
8122-1098-P	128mm	67	8342-1055-P	18in.	93	9206-1BPN-P	224mm	69	9253-10BT-P	160mm	27	9710-1BPN-P	64mm	23	9858-1055-P	224mm	59
8123-1098-P	160mm	67	8343-1MDB-P	18in.	93	9207-1026-P	224mm	69	9254-1ORB-P	Knob	27	9711-1BAC-P	64mm	23	9859-1055-P	320mm	59
8124-1098-P	224mm	67	9109-1BPN-P	18in.	87	9208-1055-P	224mm	69	9255-1BPN-P	Knob	27	9712-1BBN-P	64mm	23	9860-1BPN-P	18in.	59
8125-1098-P	12in.	67	9139-1BPN-P	128mm	87	9209-1BPN-P	Knob	69	9256-10BT-P	Knob	27	9713-1BAB-P	64mm	23	9861-1055-P	18in.	59
8302-1MDB-P	Knob	93	9140-1BPN-P	160mm	87	9210-1026-P	Knob	69	9257-1014-P	3in.	87	9714-1MDB-P	Knob	126	9897-1MDB-P	96mm	59
8303-1MDB-P	96mm	93	9141-1BPN-P	224mm	87	9211-1055-P	Knob	69	9258-1014-P	96mm	87	9718-1BPN-P	96mm	23	9898-1MDB-P	128mm	59
8304-1MDB-P	128mm	93	9142-1BPN-P	12in.	87	9221-1ORB-P	3in.	87	9259-1014-P	Knob	87	9719-1BAC-P	96mm	23	9899-1MDB-P	160mm	59
8305-1MDB-P	160mm	93	9143-1055-P	128mm	87	9222-1BPN-P	3in.	87	9260-1055-P	3in.	87	9720-1BBN-P	96mm	23	9901-1MDB-P	224mm	59
8306-1MDB-P	224mm	93	9144-1055-P	160mm	87	9223-10VB-P	3in.	87	9261-1055-P	96mm	87	9721-1BAB-P	96mm	23	9902-1MDB-P	320mm	59
8307-1MDB-P	12in.	93	9145-1055-P	224mm	87	9224-1ORB-P	96mm	87	9262-1055-P	Knob	87	9722-1BAC-P	Knob	23	9903-1MDB-P	Knob	59
8308-1055-P	Knob	93	9146-1055-P	12in.	87	9225-1BPN-P	96mm	87	9437-10VB-P	3in.	95	9723-1BBN-P	Knob	23	9904-1026-P	224mm	59
8309-1055-P	96mm	93	9147-1055-P	18in.	87	9226-10VB-P	96mm	87	9438-1BPN-P	3in.	95	9724-1BAB-P	Knob	23	9905-1026-P	320mm	59
8310-1055-P	128mm	93	9148-1ORB-P	128mm	87	9227-1ORB-P	Knob	87	9439-1055-P	96mm	53	9803-1VTN-P	128mm	17	9906-1SLT-P	96mm	59
8311-1055-P	160mm	93	9149-1ORB-P	160mm	87	9228-1BPN-P	Knob	87	9440-1055-P	128mm	53	9804-1VTN-P	12in.	17	9907-1SLT-P	128mm	59
8312-1055-P	224mm	93	9150-1ORB-P	224mm	87	9229-10VB-P	Knob	87	9441-1055-P	Knob	53	9806-1VTN-P	96mm	17	9908-1SLT-P	160mm	59
8313-1055-P	12in.	93	9151-1ORB-P	12in.	87	9230-1026-P	96mm	7	9443-10VB-P	96mm	95	9807-1VTN-P	160mm	17	9909-1SLT-P	224mm	59
8314-1BPN-P	Knob	93	9152-1014-P	128mm	87	9231-1BPN-P	96mm	7	9444-1BPN-P	96mm	95	9808-1VTN-P	224mm	17	9912-1MDB-P	18in.	59
8315-1BPN-P	96mm	93	9153-1014-P	160mm	87	9232-10BT-P	96mm	7	9449-10VB-P	128mm	95	9809-1VTN-P	Knob	17	9913-1BPN-P	Knob	23
8316-1BPN-P	128mm	93	9154-1014-P	224mm	87	9233-1026-P	128mm	7	9450-1BPN-P	128mm	95	9812-1BPN-P	160mm	55	9916-1026-P	18in.	59
8317-1BPN-P	160mm	93	9155-1014-P	12in.	87	9234-1BPN-P	128mm	7	9455-10VB-P	160mm	95	9813-1BPN-P	224mm	55	9946-1MDB-P	3in.	93

Part No.	CC/Type	Page No.
9947-1055-P	3in.	93
9970-1SLT-P	320mm	59
9971-1SLT-P	Knob	59
9973-1SLT-P	18in.	59
9974-1BPN-P	320mm	69
9975-1055-P	320mm	69
9976-1MDB-P	3in. & 96mm	69
9977-1MDB-P	160mm	69
9978-1MDB-P	224mm	69
9993-1MDB-P	320mm	69
9995-1MDB-P	Knob	69



ADDITIONAL QUESTIONS?

Check our FAQ section on our website, scan the QR Code above, or email us at Info@BerensonHardware.com

WHERE CAN I SEE AND BUY BERENSON HARDWARE ON DISPLAY?

You can purchase Berenson hardware from a variety of sources, including architectural hardware showrooms, kitchen and bath oriented dealers, and internet re-sellers.

To find the retailer nearest to you, visit our website Find a Store page. If you carry Berenson product and would like your business to be listed on our Find a Store page, please contact your sales representative or fill out the List My Store form.

DO YOU OFFER AN ONLINE CATALOG?

Yes, you can view and download a digital copy of all of our current catalogs on our website, BerensonHardware.com. Locate them from our Main Menu under the Support section.

IS THERE A MINIMUM ORDER QUANTITY?

There is no minimum order quantity or broken box charge. Berenson will ship any product in any quantity.

HOW SOON ARE ITEMS SHIPPED AFTER BEING ORDERED?

Orders placed before 3:00 PM EST will ship the same day.

Large orders that must ship by truck will go out the day after the order is placed.

DO YOU OFFER DROP SHIPMENTS?

Yes, we will ship right to your customer if needed.

DO YOUR PRODUCTS COME WITH SCREWS AND WHAT LENGTH ARE THEY?

Yes, most hardware includes 8-32 x 1in. machine screws or M4 x 45mm break off screws.

Appliance pulls come with 10-24 x 1in. machine screws.

Please see product data tables on collection pages to find out which type of screw comes with each part.

WHAT IS THE BEST WAY TO CARE FOR HARDWARE?

Our decorative hardware is best cleaned with warm water, mild soap, and a soft cloth when necessary. Avoid the use of abrasive cleaning products or window cleaner. Over time, the use of such products will result in the removal of the protective coating.

Inches	Millimeters
1 ¼in.	32mm
2 ¾in.	56mm
2 ½in.	64mm
3in.	76.2mm
3 ½in.	83.9mm
3 ²⁄₃in.	96mm
4in.	101.6mm
4 ¹⁄₂in.	112mm
5 ¼in.	128mm
6in.	152.4mm
6 ⁵⁄₁₆in.	160mm
6 ²⁄₃in.	169mm
7 ⁹⁄₁₆in.	192mm
8 ¹³⁄₁₆in.	224mm
10 ¼in.	256mm
11 ¹⁄₂in.	288mm
12in.	304.8mm
12 ¹⁹⁄₃₂in.	320mm
15 ½in.	384mm
16 ³⁄₈in.	416mm
17 ²⁄₃in.	448mm
18in.	457.2mm
21 ¹³⁄₃₂in.	544mm
25 ⁷⁄₃₂in.	640mm
26 ²⁵⁄₃₂in.	672mm
30 ⁷⁄₃₂in.	768mm



2495 Main Street, Suite 111 Buffalo, NY 14214-2152
 Phone: 800.333.0578 | Fax: 716.833.2402
 Email: Info@BerensonHardware.com
BerensonHardware.com

FOLLOW US ON SOCIAL MEDIA!



Scan the QR code for easy access to our social media pages & to view our digital catalogs!



© 2026 Berenson Corp

Catalog 20
 26.02
 0515-MARK-01